



Contatti



Amministrazione

amministrazione@ritesa.it



Vendita

eugenio@ritesa.it



Marketing

marketing@ritesa.it



Responsabile Commerciale

pino@ritesa.it



Acquisti

acquisti@ritesa.it



Informazioni

info@ritesa.it



www.ritesa.it

vai nel nostro catalogo online

Siamo tra i primi a fornirvi
la conferma d'ordine figurata
con l'immagine dei prodotti,
in tempi reali.

NB: I prezzi del seguente listino si intendono esclusi da IVA e possono subire variazioni in qualsiasi momento e senza nessun preavviso, quindi avrà validità il prezzo in vigore al momento della consegna.



Riscaldamento Termo Sanitari

Tel.: +39 0962 82473 - Fax.: +39 0962 82388 : <http://www.ritesa.it> - ✉: info@ritesa.it

Storia

Storia

indice figurato

indice figurato

indice figurato

indice figurato

indice figurato

indice figurato

indice figurato

indice figurato

indice figurato

indice figurato

indice figurato

indice figurato

INTERPRETAZIONE DEI CODICI



CODICE	MISURA	UM	PZ	€
001 001 001	D. 16 x 12 x 2 all 0,2	ML	100	1,50
001 001 002	D. 20 x 16 x 2 all 0,2	ML	100	2,30
001 002 001	D. 16 x 11,25 x 2,25 all 0,4	ML	50	3,90
001 002 002	D. 20 x 15 x 2,50 all 0,4	ML	50	4,80
001 001 004	D. 26 x 20 x 3 all 0,5	ML	25	6,60
001 002 004	D. 32 x 26 x 3 all 0,5	ML	25	8,90



Riscaldamento Termo Sanitari

Tel.: +39 0962 82473 - Fax.: +39 0962 82388 : <http://www.ritesa.it> - : info@ritesa.it

INDICE



IDRAULICA

001	RACCORDERIA MINUTERIA IDRAULICA E TUBAZIONI	01 > 30
002	POMPE ELETTROPOMPE AUTOCLAVI DEPURATORI E ACCESSORI	31 > 37
003	GUARNIZIONI GOMMINI MORSETTI COIBENTAZIONE	38 > 40
004	CANAPA TEFLON PASTA VERDE COLLANTI SILICONE	41 > 42
005	SEDILI WC LEGNO ABS PVC E CERNIERE	43 > 43
006	VALVOLE RUBINETTI A SFERA TERMOIDRALICI RISCALDAMENTO E GAS	44 > 49
007	PILETTAME SIFONAME COLONNE CANOTTI E ROSONI	50 > 58
008	SISTEMI DI FISSAGGIO E ANCORAGGIO IDRAULICI	59 > 60
009	TUBI CASSETTE E RACCORDI DI SCARICO IDRAULICI	61 > 70
010	CABINE BOX DOCCIA E VASCHE	71 > 76
011	RUBINETTERIA TRADIZIONALE MISCELATORI TERMOSTATICI E LEVA CLINICA	77 > 85
013	DOCCETTE FLESSIBILI SALISCENDI DOCCE TENDE E TELAI	86 > 89
015	VASCHE BOX ACRILICI IDROMASSAGGIO E SENZA	90 > 90
017	MOBILI SPECCHI E ACCESSORI BAGNO E LAVANDERIA	91 > 97
024	SANITARI LAVABI PIATTI DOCCIA	98 > 103
026	CONTENITORI ACQUA SERBATOI CISTERNE ZINCATE E POLIETILENE	104 > 106



RISCALDAMENTO

014	PIASTRE TUBOLARI RADIATORI ALLUMINIO E TERMOARREDI	107 > 107
016	SCALDACQUA ELETTRICI E GAS E CALDAIE A GAS	108 > 126
019	RACCORDERIA MINUTERIA STRUMENTAZIONE PER RISCALDAMENTO	127 > 147
025	ACCESSORI PRODOTTI PER ANTINCENDIO	148 > 148
028	FUMISTERIA E ACCESSORI	149 > 154



CONDIZIONAMENTO

012	GENERATORI ARIA CALDA TERMOCONVETTORI VENTILCONVETTORI GAS E IDRONICI	155 > 160
023	CLIMATIZZATORI	161 > 162



ECOENERGIA

022	CALDAIE CAMINI TERMOSTUFE POLICOMBUSTIBILE	163 > 165
029	SOLARE TERMICO	166 > 169





IDRAULICA



Riscaldamento Termo Sanitari

Tel.: +39 **0962 82473** - Fax.: +39 **0962 82388** : <http://www.ritesa.it> - : info@ritesa.it



**Tubo Multistrato
Nudo Prandelli**

CODICE	MISURA	UM	PZ	€
001 001 001	D. 16 x 12 x 2 all 0,2	ML	100	1,50
001 001 002	D. 20 x 16 x 2 all 0,2	ML	100	2,30
001 002 001	D. 16 x 11,25 x 2,25 all 0,4	ML	50	3,90
001 002 002	D. 20 x 15 x 2,50 all 0,4	ML	50	4,80
001 001 004	D. 26 x 20 x 3 all 0,5	ML	25	6,60
001 002 004	D. 32 x 26 x 3 all 0,5	ML	25	8,90



**Tubo Multistrato
Isolato Prandelli**

CODICE	MISURA	UM	PZ	€
001 001 003	D. 16 x 12 x 2 all 0,2	ML	50	2,30
001 001 006	D. 20 x 16 x 2 all 0,2	ML	50	3,00
001 002 007	D. 16 x 11,25 x 2,25 all 0,4	ML	50	4,00
001 002 008	D. 20 x 15 x 2,50 all 0,4	ML	50	4,80
001 001 007	D. 26 x 20 x 3 all 0,5	ML	25	7,20
001 002 010	D. 32 x 26 x 3 all 0,5	ML	25	13,40



**Tubo Multistrato
Isolato per Refrigerazione**

CODICE	MISURA	UM	PZ	€
001 001 120	D.16 Isol.13 TFR 15,50	ML	50	2,40
001 001 121	D.20 Isol.13 TFR 20,50	ML	50	3,50
001 001 122	D.26 Isol.13 TFR 25,25	ML	25	6,40
001 001 123	D.32 Isol.13 TFR 32,25	ML	25	10,50

CODICE	MISURA	UM	PZ	€
001 001 110	D. 16 x 12 x 2 all 0,2	ML	100	1,50
001 001 111	D. 20 x 16 x 2 all 0,2	ML	100	2,20
001 001 112	D. 26 x 20 x 3 all 0,2	ML	50	4,30

Tubo Multistrato
Nudo Bianco



CODICE	MISURA	UM	PZ	€
001 001 100	D. 16 x 12 x 2 all 0,2	ML	50	1,90
001 001 101	D. 20 x 16 x 2 all 0,2	ML	50	2,70
001 001 102	D. 26 x 20 x 3 all 0,3	ML	25	5,50
001 001 103	D. 32 x 26 x 3 all 0,3	ML	25	8,60

Tubo Multistrato
Isolato



CODICE	MISURA	UM	PZ	€
001 001 130	D. 16 x 12 x 2 all 0,2	ML	50	3,10
001 001 131	D. 20 x 16 x 2 all 0,25	ML	50	3,90
001 001 132	D. 26 x 20 x 3 all 0,3	ML	50	7,10

Tubo Multistrato
già Inguainato per Gas



CODICE	MISURA	UM	PZ	€
001 001 140	D. 16 x 12 x 2 all 0,2	ML	50	3,10
001 001 141	D. 20 x 16 x 2 all 0,25	ML	50	3,90

Tubo Multistrato
Isolato Polietilene
Camera D'aria





Raccordo Tubo
Multistrato Stringere Fisso
Diritto Maschio

CODICE	MISURA	UM	PZ	€
001 001 009	D.16x1/2x2	PZ	10	2,90
001 001 078	D.16x3/4x2	PZ	10	3,90
001 001 080	D.20x1/2x2	PZ	10	4,30
001 001 010	D.20x3/4x2	PZ	10	4,80
001 001 201	D.26x3/4x3	PZ	10	8,60
001 001 202	D.26x1" x3	PZ	10	10,00
001 001 203	D.32x1" x3	PZ	10	14,90



Raccordo Tubo
Multistrato Stringere Fisso
Diritto Femmina

CODICE	MISURA	UM	PZ	€
001 001 011	D.16x1/2x2	PZ	10	3,20
001 001 079	D.16x3/4x2	PZ	10	4,90
001 001 081	D.20x1/2x2	PZ	10	5,10
001 001 012	D.20x3/4x2	PZ	10	5,30
001 001 205	D.26x3/4x3	PZ	10	8,60
001 001 206	D.26x1" x3	PZ	10	10,00
001 001 207	D.32x1" x3	PZ	10	14,70



Raccordo Tubo
Multistrato Stringere Fisso
Gomito Femmina

CODICE	MISURA	UM	PZ	€
001 001 013	D.16x1/2x2	PZ	10	3,80
001 001 086	D.16x3/4x2	PZ	10	5,30
001 001 082	D.20x1/2x2	PZ	10	5,60
001 001 014	D.20x3/4x2	PZ	10	6,50
001 001 209	D.26x3/4x3	PZ	10	9,10
001 001 210	D.26x1" x3	PZ	10	13,20
001 001 211	D.32x1" x3	PZ	10	14,00



Raccordo Tubo
Multistrato Stringere Fisso
Gomito Maschio

CODICE	MISURA	UM	PZ	€
001 001 015	D.16x1/2x2	PZ	10	4,20
001 001 216	D.16x3/4x2	PZ	10	5,80
001 001 083	D.20x1/2x2	PZ	10	6,00
001 001 016	D.20x3/4x2	PZ	10	5,80
001 001 213	D.26x3/4x3	PZ	10	8,70
001 001 214	D.26x1" x3	PZ	10	13,70
001 001 215	D.32x1" x3	PZ	10	14,00



Raccordo Tubo
Multistrato Stringere Fisso
Tee 3 dadi

CODICE	MISURA	UM	PZ	€
001 001 017	D.16x16x16x2	PZ	10	7,70
001 001 018	D.20x20x20x2	PZ	10	11,60
001 001 217	D.26x26x26x3	PZ	10	19,60
001 001 218	D.32x32x32x3	PZ	10	31,60



Raccordo Tubo
Multistrato Stringere Fisso
Tee Maschio

CODICE	MISURA	UM	PZ	€
001 001 019	D.16x1/2x16x2	PZ	10	5,90
001 001 020	D.20x1/2x20x2	PZ	10	7,70
001 001 084	D.20x3/4x20x2	PZ	10	8,40
001 001 220	D.26x3/4x26x3	PZ	10	12,40
001 001 221	D.26x1" x26x3	PZ	10	13,30

CODICE	MISURA	UM	PZ	€
001 001 021	D.16x1/2x16x2	PZ	10	6,30
001 001 223	D.16x3/4x16x2	PZ	10	8,50
001 001 085	D.20x1/2x20x2	PZ	10	9,80
001 001 022	D.20x3/4x20x2	PZ	10	9,20
001 001 224	D.26x3/4x26x3	PZ	10	16,30
001 001 225	D.26x1" x26x3	PZ	10	21,20
001 001 226	D.32x1" x32x3	PZ	10	28,90

Raccordo Tubo
Multistrato Stringere
Fisso Tee Femmina



CODICE	MISURA	UM	PZ	€
001 001 023	D.16x1/2X2	PZ	10	4,60
001 001 024	D.20x1/2x2	PZ	10	6,50
001 001 228	D.20x3/4x2	PZ	10	7,00

Raccordo Tubo
Multistrato Stringere
Fisso Gomito Femmina
con Flangia



CODICE	MISURA	UM	PZ	€
001 001 026	D.16x16x2	PZ	10	5,30
001 001 027	D.20x20x2	PZ	10	8,60
001 001 230	D.26x26x3	PZ	10	14,90
001 001 231	D.32x32x3	PZ	10	22,40

Raccordo Tubo
Multistrato Stringere
Giunto Doppio



CODICE	MISURA	UM	PZ	€
001 001 028	D.16x16x2	PZ	10	5,70
001 001 029	D.20x20x2	PZ	10	8,10
001 001 233	D.26x26x3	PZ	10	14,50
001 001 234	D.32x32x3	PZ	10	24,20

Raccordo Tubo
Multistrato Stringere
Fisso Gomito Doppio



CODICE	MISURA	UM	PZ	€
001 001 033	D.16/32	PZ	1	79,10

Calibratore Allargatubi
per Multistrato



CODICE	MISURA	UM	PZ	€
001 002 373	D.14x1/2x2,00	PZ	10	2,80
001 167 012	D.16x1/2x2,00	PZ	10	2,70
001 002 376	D.16x1/2x2,25	PZ	10	3,00
001 002 374	D.16x3/4x2,25	PZ	10	3,60
001 002 378	D.20x3/4x2,00	PZ	10	4,00
001 002 379	D.20x3/4x2,25	PZ	10	4,20

Adattatore Dado Anello e
Portagomma per Tubo
Multistrato





Raccordo Tubo Multistrato Stringere Removibile Diritto Maschio

CODICE	MISURA	UM	PZ	€
001 001 850	D.16x1/2x2	PZ	10	4,30
001 001 855	D.20x1/2x2	PZ	10	6,30
001 001 856	D.20x3/4x2	PZ	10	6,90
001 001 860	D.26x3/4x3	PZ	10	12,10
001 001 861	D.26x1" x3	PZ	10	11,40



Raccordo Tubo Multistrato Stringere Removibile Diritto Femmina

CODICE	MISURA	UM	PZ	€
001 001 865	D.16x1/2x2	PZ	10	4,90
001 001 866	D.20x1/2x2	PZ	10	6,50
001 001 867	D.20x3/4x2	PZ	10	6,50
001 001 870	D.26x3/4x3	PZ	10	12,50
001 001 871	D.26x1" x3	PZ	10	11,80



Raccordo Tubo Multistrato Stringere Removibile Diritto Doppio

CODICE	MISURA	UM	PZ	€
001 001 875	D.16x16x2	PZ	10	7,10
001 001 877	D.20x20x2	PZ	10	10,50
001 001 881	D.26x26x3	PZ	10	17,10



Raccordo Tubo Multistrato Stringere Removibile Diritto Doppio Ridotto

CODICE	MISURA	UM	PZ	€
001 001 876	D.20x16x2	PZ	10	8,70
001 001 880	D.26x20x2	PZ	10	19,40



Raccordo Tubo Multistrato Stringere Removibile Tee Femmina

CODICE	MISURA	UM	PZ	€
001 001 885	D.16x1/2x16x2	PZ	10	9,50
001 001 886	D.20x1/2x20x2	PZ	10	14,00
001 001 887	D.20x3/4x20x2	PZ	10	12,20
001 001 890	D.26x3/4x26x3	PZ	10	24,10
001 001 891	D.26x1" x26x3	PZ	10	21,70



Raccordo Tubo Multistrato Stringere Removibile Tee Maschio

CODICE	MISURA	UM	PZ	€
001 001 895	D.16x1/2x16x2	PZ	10	9,30
001 001 897	D.20x3/4x20x2	PZ	10	13,70
001 001 900	D.26x3/4x26x3	PZ	10	20,00
001 001 901	D.26x1" x26x3	PZ	10	22,20



CODICE	MISURA	UM	PZ	€
001 001 905	D.16x16x16x2	PZ	10	12,20
001 001 907	D.20x20x20x2	PZ	10	16,20
001 001 910	D.26x26x26x3	PZ	10	25,40

Raccordo Tubo
Multistrato Stringere
Removibile Tee 3 Dadi



CODICE	MISURA	UM	PZ	€
001 001 915	D.16x1/2x2	PZ	10	4,90
001 001 916	D.20x1/2x2	PZ	10	7,20
001 001 917	D.20x3/4x2	PZ	10	7,60
001 001 920	D.26x3/4x3	PZ	10	12,50
001 001 921	D.26x1" x3	PZ	10	11,00

Raccordo Tubo
Multistrato Stringere
Removibile Gomito
Maschio



CODICE	MISURA	UM	PZ	€
001 001 925	D.16x1/2x2	PZ	10	5,70
001 001 926	D.20x1/2x2	PZ	10	7,40
001 001 927	D.20x3/4x2	PZ	10	8,20
001 001 929	D.26x3/4x3	PZ	10	13,60
001 001 930	D.26x1" x3	PZ	10	19,60

Raccordo Tubo
Multistrato Stringere
Removibile Gomito
Femmina



CODICE	MISURA	UM	PZ	€
001 001 935	D.16x16x2	PZ	10	8,40
001 001 936	D.20x20x2	PZ	10	10,80
001 001 940	D.26x26x3	PZ	10	17,40

Raccordo Tubo
Multistrato Stringere
Removibile Gomito
Doppio



CODICE	MISURA	UM	PZ	€
001 001 950	D.16x1/2x2	PZ	10	7,10
001 001 956	D.20x1/2x2	PZ	10	7,20
001 001 960	D.26x3/4x3	PZ	10	16,40

Raccordo Tubo
Multistrato Stringere
Fisso Gomito Femmina
con Flangia



CODICE	MISURA	UM	PZ	€
001 001 970	D.20x16x16x2	PZ	10	13,70
001 001 971	D.16x20x16x2	PZ	10	13,70
001 001 972	D.26x20x26x3	PZ	10	25,30

Raccordo Tubo
Multistrato Stringere
Removibile Tee Ridotta
3 Dadi





Raccordo Tubo Multistrato
Pressare Diritto Maschio

CODICE	MISURA	UM	PZ	€
001 001 501	D.16x1/2x2	PZ	10	3,30
001 001 506	D.20x1/2x2	PZ	10	3,90
001 001 502	D.20x3/4x2	PZ	10	5,30
001 001 503	D.26x3/4x3	PZ	10	6,00
001 001 504	D.26x1" x3	PZ	10	8,10
001 001 505	D.32x1" x3	PZ	10	10,20



Raccordo Tubo Multistrato
Pressare Diritto Femmina

CODICE	MISURA	UM	PZ	€
001 001 507	D.16x1/2x2	PZ	10	4,10
001 001 512	D.20x1/2x2	PZ	10	4,70
001 001 508	D.20x3/4x2	PZ	10	5,50
001 001 509	D.26x3/4x3	PZ	10	6,40
001 001 510	D.26x1" x3	PZ	10	7,90
001 001 511	D.32x1" x3	PZ	10	8,30



Raccordo Tubo Multistrato
Pressare Diritto Doppio

CODICE	MISURA	UM	PZ	€
001 001 513	D.16x16x2	PZ	10	3,70
001 001 514	D.20x20x2	PZ	10	4,70
001 001 515	D.26x26x3	PZ	10	7,70
001 001 516	D.32x32x3	PZ	10	11,40



Raccordo Tubo Multistrato
Pressare Diritto Doppio
Ridotto

CODICE	MISURA	UM	PZ	€
001 001 518	D.20x16x2	PZ	10	4,70
001 001 519	D.26x16x2	PZ	10	8,50
001 001 520	D.26x20x3	PZ	10	8,80
001 001 521	D.32x26x3	PZ	10	10,90



Raccordo Tubo Multistrato
Pressare Gomito Femmina

CODICE	MISURA	UM	PZ	€
001 001 524	D.16x1/2x2	PZ	10	4,50
001 001 529	D.20x1/2x2	PZ	10	5,80
001 001 525	D.20x3/4x2	PZ	10	8,30
001 001 526	D.26x3/4x3	PZ	10	8,80
001 001 527	D.26x1" x3	PZ	10	13,50
001 001 528	D.32x1" x3	PZ	10	12,60



Raccordo Tubo Multistrato
Pressare Gomito Maschio

CODICE	MISURA	UM	PZ	€
001 001 531	D.16x1/2x2	PZ	10	4,60
001 001 532	D.20x1/2x2	PZ	10	7,00
001 001 536	D.20x3/4x2	PZ	10	7,70
001 001 533	D.26x3/4x3	PZ	10	8,00
001 001 534	D.26x1" x3	PZ	10	10,30
001 001 535	D.32x1" x3	PZ	10	10,80



CODICE	MISURA	UM	PZ	€
001 001 537	D.16x16x2	PZ	10	4,70
001 001 538	D.20x20x2	PZ	10	7,20
001 001 539	D.26x26x3	PZ	10	11,00
001 001 540	D.32x32x3	PZ	10	13,70

Raccordo Tubo Multistrato
Pressare Gomito Doppio



CODICE	MISURA	UM	PZ	€
001 001 542	D.16x16x16x2	PZ	10	6,70
001 001 543	D.20x20x20x2	PZ	10	9,60
001 001 544	D.26x26x26x3	PZ	10	13,50
001 001 545	D.32x32x32x3	PZ	10	16,40

Raccordo Tubo Multistrato
Pressare Tee Intermedia



CODICE	MISURA	UM	PZ	€
001 001 548	D.16x1/2x16x2	PZ	10	8,00
001 001 549	D.20x1/2x20x2	PZ	10	9,60
001 001 553	D.20x3/4x20x2	PZ	10	10,30
001 001 550	D.26x3/4x26x3	PZ	10	13,90
001 001 551	D.26x1" x26x3	PZ	10	20,30
001 001 552	D.32x1" x32x3	PZ	10	17,00

Raccordo Tubo Multistrato
Pressare Tee Femmina



CODICE	MISURA	UM	PZ	€
001 001 554	D.16x1/2x16x2	PZ	10	7,80
001 001 555	D.20x1/2x20x2	PZ	10	7,90
001 001 559	D.20x3/4x20x2	PZ	10	11,80
001 001 556	D.26x3/4x26x3	PZ	10	14,80
001 001 557	D.26x1" x26x3	PZ	10	19,80
001 001 558	D.32x1" x32x3	PZ	10	19,60

Raccordo Tubo Multistrato
Pressare Tee Maschio



CODICE	MISURA	UM	PZ	€
001 001 560	D.16x20x16x2	PZ	10	9,70
001 001 561	D.20x16x20x2	PZ	10	10,00
001 001 568	D.20x20x16x2	PZ	10	9,50
001 001 562	D.20x16x16x2	PZ	10	9,80
001 001 563	D.26x16x26x3	PZ	10	13,90
001 001 564	D.26x20x26x3	PZ	10	17,10
001 001 567	D.32x16x32x3	PZ	10	15,70
001 001 565	D.32x20x32x3	PZ	10	19,60
001 001 566	D.32x26x32x3	PZ	10	20,40

Raccordo Tubo Multistrato
Pressare Tee Intermedia
Ridotta



CODICE	MISURA	UM	PZ	€
001 001 581	D.16X1/2X2	PZ	10	5,90
001 001 582	D.20x1/2x2	PZ	10	7,60

Raccordo Tubo Multistrato
Pressare Gomito Femmina
con Flangia



CODICE	MISURA	UM	PZ	€
001 001 585	D.16x1/2x2	PZ	10	5,30
001 001 586	D.20x3/4x2	PZ	10	5,30

Raccordo Tubo Multistrato
Pressare Diritto Eurocono
Folle





SETTORE 001

IDRAULICA



Raccordo Tubo Multistrato
Pressare Gas
Diritto Maschio

CODICE	MISURA	UM	PZ	€
001 001 701	D.16X1/2X2	PZ	10	4,40
001 001 702	D.20x1/2x2	PZ	10	5,30
001 001 703	D.20x3/4x2	PZ	10	7,00
001 001 704	D.26x3/4x3	PZ	10	10,50
001 001 705	D.26x1" x3	PZ	10	13,90



Raccordo Tubo Multistrato
Pressare Gas
Diritto Femmina

CODICE	MISURA	UM	PZ	€
001 001 707	D.16X1/2X2	PZ	10	4,80
001 001 708	D.20x1/2x2	PZ	10	6,10
001 001 709	D.20x3/4x2	PZ	10	7,00
001 001 710	D.26x3/4x3	PZ	10	11,10
001 001 711	D.26x1" x3	PZ	10	13,30



Raccordo Tubo Multistrato
Pressare Gas
Diritto Doppio

CODICE	MISURA	UM	PZ	€
001 001 713	D.16x16x2	PZ	10	6,00
001 001 714	D.20x20x2	PZ	10	8,10
001 001 715	D.26x26x3	PZ	10	11,00



Raccordo Tubo Multistrato
Pressare Gas
Diritto Doppio Ridotto

CODICE	MISURA	UM	PZ	€
001 001 718	D.20x16x2	PZ	10	8,00
001 001 719	D.26x16x3	PZ	10	12,00
001 001 720	D.26x20x3	PZ	10	13,00



Raccordo Tubo Multistrato
Pressare Gas
Gomito Femmina

CODICE	MISURA	UM	PZ	€
001 001 724	D.16x1/2x2	PZ	10	6,20
001 001 725	D.20x1/2x2	PZ	10	7,20
001 001 726	D.20x3/4x2	PZ	10	10,70
001 001 727	D.26x3/4x3	PZ	10	16,80
001 001 728	D.26x1" x3	PZ	10	22,60



Raccordo Tubo Multistrato
Pressare Gas
Gomito
Maschio

CODICE	MISURA	UM	PZ	€
001 001 731	D.16x1/2x2	PZ	10	7,50
001 001 732	D.20x1/2x2	PZ	10	8,80
001 001 733	D.20x3/4x2	PZ	10	10,50
001 001 734	D.26x3/4x3	PZ	10	14,30
001 001 735	D.26x1" x3	PZ	10	20,50



Raccordo Tubo Multistrato
Pressare Gas
Tee Femmina

CODICE	MISURA	UM	PZ	€
001 001 748	D.16x1/2x2	PZ	10	10,80
001 001 749	D.20x3/4x2	PZ	10	17,20
001 001 750	D.26x3/4x3	PZ	10	29,60
001 001 751	D.26x1" x3	PZ	10	35,80



Raccordo Tubo Multistrato
Pressare Gas Tee Maschio

CODICE	MISURA	UM	PZ	€
001 001 754	D.16x1/2x2	PZ	10	6,90
001 001 755	D.20x1/2x2	PZ	10	9,20
001 001 756	D.26x3/4x3	PZ	10	29,60
001 001 757	D.26x1" x3	PZ	10	14,90



Raccordo Tubo Multistrato
Pressare Gas
Gomito Femmina con Flangia

CODICE	MISURA	UM	PZ	€
001 001 781	D.16x1/2x2	PZ	10	10,40
001 001 782	D.20x1/2x2	PZ	10	11,50
001 001 783	D.20x3/4x2	PZ	10	12,20



CODICE	MISURA	UM	PZ	€
001 001 786	D.16x1/2x2	PZ	10	16,90
001 001 787	D.20x1/2x2	PZ	10	16,70

Raccordo Tubo Multistrato Pressare Gas Gomito Femmina con Flangia collo lungo per cassetta



CODICE	MISURA	UM	PZ	€
001 001 737	D.16x16x2	PZ	10	7,60
001 001 738	D.20x20x2	PZ	10	9,60
001 001 739	D.26x26x3	PZ	10	17,50

Raccordo Tubo Multistrato Pressare Gas Gomito Doppio



CODICE	MISURA	UM	PZ	€
001 001 742	D.16x16x16x2	PZ	10	10,70
001 001 743	D.20x20x20x2	PZ	10	14,40
001 001 744	D.26x26x26x3	PZ	10	26,10

Raccordo Tubo Multistrato Pressare Gas Tee Intermedia



CODICE	MISURA	UM	PZ	€
001 001 761	D.20x16x20x2	PZ	10	13,80
001 001 760	D.26x20x26x3	PZ	10	15,40
001 001 759	D.26x16x26x3	PZ	10	24,50

Raccordo Tubo Multistrato Pressare Gas Tee Ridotta Centrale



CODICE	MISURA	UM	PZ	€
001 001 762	D.20x16x16x2	PZ	10	9,50
001 001 763	D.20x20x16x2	PZ	10	9,50

Raccordo Tubo Multistrato Pressare Gas Tee Ridotta Laterale



CODICE	MISURA	UM	PZ	€
019 100 078	Cm 12x8	PZ	1	18,90

Cassetta Incasso Gas Ispezionabile per Giunzione Raccordi Pressare



CODICE	MISURA	UM	PZ	€
001 001 795	D.12	PZ	10	0,50
001 001 796	D.14	PZ	10	0,50
001 001 797	D.16	PZ	10	0,50
001 001 798	D.18	PZ	10	0,60
001 001 799	D.22	PZ	10	1,00

O'Ring Giallo Gas per Tubo Rame



CODICE	MISURA	UM	PZ	€
001 001 765	D.16x3/4x2	PZ	10	12,40
001 001 766	D.20x3/4x2	PZ	10	13,30

Raccordo Tubo Multistrato Pressare Gas Dritto Folle



CODICE	MISURA	UM	PZ	€
019 100 077	D.16	PZ	10	94,50

Rubinetto Incasso Gas Ispezionabile Completa Raccordi a Pressare





Collare in Ghisa
Pesante Presa Acqua

CODICE	MISURA	UM	PZ	€
001 091 009	D.1"X40	PZ	1	37,80
001 091 010	D.1"X50	PZ	1	42,70
001 091 011	D.1"X60	PZ	1	49,10
001 091 012	D.1"X80	PZ	1	66,20
001 091 013	D.1"X100	PZ	1	68,50
001 091 014	D.1"X125	PZ	1	68,80



Collare di Riparazione
per Tubo Zincato
1 Bullone

CODICE	MISURA	UM	PZ	€
001 003 004	D.21-25 mm T1	PZ	10	9,80
001 003 001	D.26-30 mm T1	PZ	10	9,80
001 003 002	D.29-33 mm T1	PZ	10	10,10
001 003 003	D.33-37 mm T1	PZ	1	10,10
001 003 005	D.38-42 mm T1	PZ	1	10,30
001 003 006	D.42-45 mm T1	PZ	1	10,30
001 003 007	D.44-48 mm T1	PZ	1	10,60
001 003 008	D.48-51 mm T1	PZ	1	10,80
001 003 009	D.50-54 mm T1	PZ	1	11,10
001 003 010	D.55-60 mm T1	PZ	1	12,00
001 003 011	D.60-64 mm T1	PZ	1	14,70



Collare di Riparazione
per Tubo Zincato
3 Bulloni

CODICE	MISURA	UM	PZ	€
001 003 023	D.60-68 mm T3	PZ	1	103,50
001 003 024	D.68-78 mm T3	PZ	1	103,50
001 003 025	D.78-88 mm T3	PZ	1	103,50
001 003 026	D.88-98 mm T3	PZ	1	103,50
001 003 027	D.98-108 mm T3	PZ	1	103,60
001 003 028	D.108-118 mm T3	PZ	1	113,10
001 003 029	D.114-126 mm T3	PZ	1	116,00
001 003 030	D.126-138 mm T3	PZ	1	122,80
001 003 031	D.138-150 mm T3	PZ	1	125,60
001 003 032	D.162-174 mm T3	PZ	1	131,20



Collare Presa
Staffa Rapido
in Ottone

CODICE	MISURA	UM	PZ	€
001 003 050	D.1/2x1/2	PZ	10	8,60
001 003 051	D.3/4x1/2	PZ	10	12,10
001 003 052	D.1" x1/2	PZ	10	16,60



CODICE	MISURA	UM	PZ	€
001 156 010	D. 3/8	PZ	5	27,60

Galleggiante FluidMaster Its Todini Laterale



CODICE	MISURA	UM	PZ	€
001 164 008	D. 3/8	PZ	5	8,60

Galleggiante Universale Compatto per Cassetta Zaino



CODICE	MISURA	UM	PZ	€
009 078 040	D. 3/8 - Geberit 240.784.00.1	PZ	1	86,60

Ricambi Geberit Rubinetto Galleggiante Tipo380 (Tipo Universale)



CODICE	MISURA	UM	PZ	€
009 077 008	D. 3/8 - Grohe 37092	PZ	1	87,60

Ricambio Cassetta Grohe Galleggiante Valvola Carico



CODICE	MISURA	UM	PZ	€
001 006 014	D.3/4	PZ	10	14,60
001 006 020	D.1"	PZ	10	20,70
001 006 021	D.1"1/4	PZ	10	45,40

Galleggiante 5 Coppiglie Asta Piatta



CODICE	MISURA	UM	PZ	€
001 003 013	D.1/2 Asta Tonda 5/16	PZ	10	15,10
001 006 015	D.3/4 Asta Tonda 5/16	PZ	10	16,70
001 006 042	D.1" Asta Tonda 5/16	PZ	10	23,60

Galleggiante Tipo Inglese Asta Tonda



CODICE	MISURA	UM	PZ	€
001 006 016	D.3/4	PZ	10	28,30
001 006 017	D.1"	PZ	10	30,60
001 006 024	D.1"1/4	PZ	5	87,60

Galleggiante Doppia Leva Sede Inox



CODICE	MISURA	UM	PZ	€
001 006 018	D.3/8	PZ	10	9,50
009 164 003	D.1/2	PZ	10	10,50

Galleggiante Cassetta Zaino



CODICE	MISURA	UM	PZ	€
001 006 025	D.1"1/2	PZ	1	87,10
001 006 026	D.2"	PZ	1	151,10

Galleggiante Doppia Leva Sede Ottone



CODICE	MISURA	UM	PZ	€
001 155 003	D.3/8	PZ	10	11,00
001 155 004	D.1/2 Senza Sfera	PZ	10	14,70
001 155 007	D.3/8 Con Sfera	PZ	10	12,20

Galleggiante Catis





Galleggiante Globus Farg
Sfera Estraibile Inox Aisi 430

CODICE	MISURA	UM	PZ	€
001 006 010	D.3/4 Inox Aisi 430	Pz	1	54,90



Galleggiante Farg
con Sfera

CODICE	MISURA	UM	PZ	€
001 155 110	D.3/8	PZ	10	10,40
001 155 111	D.1/2	PZ	10	12,20



Galleggiante Alta Pressione
Silenzioso

CODICE	MISURA	UM	PZ	€
001 006 027	D.1"1/4	PZ	10	87,90
001 006 028	D.1"1/2	PZ	10	91,30



Sfera Galleggiante Tonda
Rame Con Nottolino

CODICE	MISURA	UM	PZ	€
001 001 061	D.85 Nottolino 1/4	PZ	10	6,90



Sfera con Reggisfera in
Rame Scorrevole

CODICE	MISURA	UM	PZ	€
001 001 062	D.120 3/4	PZ	10	14,80
001 001 065	D.150 1"	PZ	10	21,60



Sfera Galleggiante Tonda
Plastica Con Nottolino

CODICE	MISURA	UM	PZ	€
001 006 046	D.90 Nottolino 1/4	PZ	10	1,20



Sfera Brevettata Catis

CODICE	MISURA	UM	PZ	€
001 155 006	Catis	PZ	10	0,90



Sfera con Reggisfera
in Plastica Scorrevole

CODICE	MISURA	UM	PZ	€
001 006 043	D.120 Scorrevole	PZ	10	3,50
001 006 044	D.150 Scorrevole	PZ	10	4,60
001 006 049	D.180 Scorrevole	PZ	5	5,60
001 006 050	D.220 Scorrevole	PZ	1	18,00
001 006 051	D.300 Scorrevole	PZ	1	42,70



Sfera Galleggiante Tonda
Plastica Con Nottolino Rosso

CODICE	MISURA	UM	PZ	€
001 006 041	D.90	PZ	10	2,30



Sfera con Reggisfera
Plastica con Nottolino
Filettato

CODICE	MISURA	UM	PZ	€
001 006 030	D.120 Nottolino 5/16	PZ	10	2,80
001 006 045	D.150 Nottolino 5/16	PZ	10	4,90

CODICE	MISURA	UM	PZ	€
019 146 086	D.3/4x1/2 M.F.	PZ	10	9,00
019 146 087	D.1" x1/2 M.F.	PZ	10	10,70

Collettore Te-Sa 2 Vie
Cromato Normale



CODICE	MISURA	UM	PZ	€
019 146 090	D.3/4x1/2 M.F.	PZ	8	12,60
019 146 091	D.1" x1/2 M.F.	PZ	8	13,40

Collettore Te-Sa 3 Vie
Cromato Normale



CODICE	MISURA	UM	PZ	€
019 146 094	D.3/4x1/2 M.F.	PZ	8	15,30
019 146 095	D.1" x1/2 M.F.	PZ	8	17,90

Collettore Te-Sa 4 Vie
Cromato Normale



CODICE	MISURA	UM	PZ	€
019 144 026	D.3/4x24x19 MF	PZ	10	14,30
019 144 027	D.1" x24x19 MF	PZ	10	16,80

Collettore Far 2 Vie
Cromato Normale Far



CODICE	MISURA	UM	PZ	€
019 144 028	D.3/4x24x19 MF	PZ	10	19,90
019 144 029	D.1" x24x19 MF	PZ	10	22,60

Collettore Far 3 Vie
Cromato Normale Far



CODICE	MISURA	UM	PZ	€
019 144 030	D.3/4x24x19 MF	PZ	10	23,50
019 144 031	D.1" x24x19 MF	PZ	10	28,10

Collettore Far 4 Vie
Cromato Normale Far



CODICE	MISURA	UM	PZ	€
019 144 020	D.3/4x24x19 MF	PZ	10	12,90
019 144 021	D.1" x24x19 MF	PZ	10	15,00

Collettore Far 2 Vie
Cromato Cieco



CODICE	MISURA	UM	PZ	€
001 017 098	D.3/4x1/2	PZ	10	8,60
001 017 004	D.1" x1/2	PZ	10	11,00

Collettore Semplice
in Ottone Giallo 2 Vie



CODICE	MISURA	UM	PZ	€
001 017 002	D.3/4x1/2	PZ	10	11,50
001 017 005	D.1" x1/2	PZ	10	16,00

Collettore Semplice
in Ottone Giallo 3 Vie



CODICE	MISURA	UM	PZ	€
001 017 003	D.3/4x1/2	PZ	10	15,50
001 017 006	D.1" x1/2	PZ	10	20,20

Collettore Semplice
in Ottone Giallo 4 Vie



CODICE	MISURA	UM	PZ	€
001 170 222	D.3/4x1/2	PZ	10	16,60
001 170 223	D.1" x1/2	PZ	10	21,40

Collettore Semplice
in Ottone Giallo 5 Vie





Collettore a Barra in Ottone Giallo Uscita Femmina

CODICE	MISURA	UM	PZ	€
001 017 050	D.1"1/4x1/2 - 2 Vie	PZ	10	17,40
001 017 051	D.1"1/4x1/2 - 3 Vie	PZ	10	26,80
001 017 052	D.1"1/4x1/2 - 4 Vie	PZ	10	35,00
001 017 053	D.1"1/4x1/2 - 5 Vie	PZ	10	43,00



Collettore Complanare e Componibile Ottone Giallo

CODICE	MISURA	UM	PZ	€
019 141 001	D.3/4x6 - 6 Vie	PZ	1	59,80
019 141 002	D.3/4x8 - 8 Vie	PZ	1	73,90
019 141 003	D.3/4x10 - 10 Vie	PZ	1	140,70



Collettore Complanare e Componibile Ottone Giallo 2 vie

CODICE	MISURA	UM	PZ	€
001 017 038	D.3/4x1/2	pz	1	50,10



Collettore in Ottone Giallo per Tubo Reticolene

CODICE	MISURA	UM	PZ	€
001 041 048	D.3/4x18 - 2 Vie	PZ	1	9,50
001 041 049	D.3/4x18 - 3 Vie	PZ	1	12,60
001 041 084	D.3/4x18 - 4 Vie	PZ	1	15,70



Collettore Te-Sa 2 Vie con Rubinetto 35° Blu/Rosso

CODICE	MISURA	UM	PZ	€
019 146 070	D.3/4x1/2 M.F.	PZ	5	16,40



Collettore Te-Sa 3 Vie con Rubinetto 35° Blu/Rosso

CODICE	MISURA	UM	PZ	€
019 146 071	D.3/4x1/2 M.F.	PZ	5	24,60



Collettore Te-Sa 4 Vie con Rubinetto 35° Blu/Rosso

CODICE	MISURA	UM	PZ	€
019 146 072	D.3/4x1/2 M.F.	PZ	4	32,80



Collettore Far 2 Vie con Rubinetto Blu/Rosso Far

CODICE	MISURA	UM	PZ	€
019 144 010	D.3/4x24x19 MF	PZ	10	34,70
019 144 011	D.1" x24x19 MF	PZ	10	38,10



Collettore Far 3 Vie con Rubinetto Blu/Rosso Far

CODICE	MISURA	UM	PZ	€
019 144 012	D.3/4x24x19 MF	PZ	10	47,90
019 144 013	D.1" x24x19 MF	PZ	10	50,90



Collettore Far 4 Vie con Rubinetto Blu/Rosso Far

CODICE	MISURA	UM	PZ	€
019 144 014	D.3/4x24x19 MF	PZ	10	62,80
019 144 015	D.1" x24x19 MF	PZ	10	70,60



CODICE	MISURA	UM	PZ	€
001 002 373	D.14x1/2x2,00	PZ	10	2,80
001 167 012	D.16x1/2x2,00	PZ	10	2,70
001 002 376	D.16x1/2x2,25	PZ	10	3,00
001 002 374	D.16x3/4x2,25	PZ	10	3,60
001 002 378	D.20x3/4x2,00	PZ	10	4,00
001 002 379	D.20x3/4x2,25	PZ	10	4,20

Adattatore
per Tubo Multistrato



CODICE	MISURA	UM	PZ	€
019 017 095	D.1/2x12	PZ	10	2,10
019 017 096	D.1/2x14	PZ	10	2,10

Dado Ottone Giallo
con Ogiva Monocono
in Teflon per Collettori

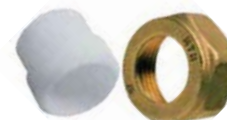

CODICE	MISURA	UM	PZ	€
019 141 009	D.1/2x12x24	PZ	10	2,40
019 141 013	D.1/2x14x24	PZ	10	2,40
019 141 024	D.1/2x16x24	PZ	10	2,40
019 141 025	D.1/2x18x24	PZ	10	2,40

Adattatore Dado Monocono
Valvola Monotubo per Tubo
Rame



CODICE	MISURA	UM	PZ	€
019 144 041	D.14x2 x24x19	PZ	10	5,50
019 144 042	D.16x2 x24x19	PZ	10	5,10
019 144 043	D.16x2,25x24x19	PZ	10	5,10
019 144 044	D.20x2 x24x19	PZ	10	5,10
019 144 045	D.20x2,25x24x19	PZ	10	5,80
019 144 046	D.20x2,50x24x19	PZ	10	5,80

Adattatore Kit per
Tubo Multistrato Far



CODICE	MISURA	UM	PZ	€
019 146 034	D.1/2 F X 3/4 M	PZ	10	7,90

Raccordo Monoblocco
per Trasformazione
Te-Sa Cromato



CODICE	MISURA	UM	PZ	€
019 146 020	D.16x1/2x2,00	PZ	10	3,20
019 146 021	D.16x1/2x2,25	PZ	10	3,20
019 146 022	D.20x3/4x2,00	PZ	10	5,70

Adattatore Kit per
Tubo Multistrato Te-Sa
Cromato



CODICE	MISURA	UM	PZ	€
019 146 023	D.20x3/4x2,00	PZ	10	9,70
019 146 024	D.20x3/4x2,00	PZ	10	8,30

Adattatore Kit per Tubo
Multistrato Te-Sa Lucido



CODICE	MISURA	UM	PZ	€
019 146 135	D.1/2x10 Art.208-04-10	PZ	10	2,40
019 146 136	D.1/2x12 Art.208-04-12	PZ	10	2,40
019 146 137	D.1/2x14 Art.208-04-14	PZ	10	2,40
019 146 138	D.1/2x16 Art.208-04-16	PZ	10	2,40
019 146 141	D.3/4x14 Art.208-05-14	PZ	10	6,50
019 146 142	D.3/4x16 Art.208-05-16	PZ	10	5,60
019 146 143	D.3/4x18 Art.208-05-18	PZ	10	5,60

Adattatore Kit per
Tubo Rame Tenuta O-Ring
Te-Sa Cromato



CODICE	MISURA	UM	PZ	€
019 146 145	D.3/4x12 Art.208HT-05-12	PZ	10	28,70
019 146 146	D.3/4x14 Art.208HT-05-14	PZ	10	31,10
019 146 060	D.1/2x12 Art.207HT-04-12	PZ	10	6,70
019 146 061	D.1/2x14 Art.207HT-04-14	PZ	10	6,20
019 146 062	D.1/2x16 Art.207HT-04-16	PZ	10	2,70

Adattatore Kit per
Tubo Rame Tenuta O-Ring
Te-Sa Lucido





Tubo Polipropilene PPR
Random
a Saldare Barre

CODICE	MISURA	UM	PZ	€
001 022 002	D.20x4Mt	ML	100	1,70
001 022 001	D.25x4Mt	ML	100	3,00
001 022 100	D.32x4Mt	ML	42	5,50



Raccordo PPR Random
a Saldare Gomito 45°
Femmina Femmina

CODICE	MISURA	UM	PZ	€
001 022 003	D.20x20	PZ	10	0,90
001 022 039	D.25x25	PZ	10	1,20
001 022 101	D.32x32	PZ	10	1,90



Raccordo PPR Random
a Saldare Gomito 90°
Femmina Femmina

CODICE	MISURA	UM	PZ	€
001 022 004	D.20x20	PZ	10	0,70
001 022 005	D.25x25	PZ	10	0,90
001 022 102	D.32x32	PZ	10	1,70



Raccordo PPR Random
a Saldare Manicotto
Femmina Femmina

CODICE	MISURA	UM	PZ	€
001 022 006	D.20x20	PZ	10	0,60
001 022 007	D.25x25	PZ	10	0,80
001 022 103	D.32x32	PZ	10	1,50



Raccordo PPR Random
a Saldare Tee
Femmina Femmina

CODICE	MISURA	UM	PZ	€
001 022 008	D.20x20x20	PZ	10	0,80
001 022 009	D.25x25x25	PZ	10	1,30
001 022 104	D.32x32x32	PZ	5	2,10



Raccordo PPR Random
a Saldare Tee Ridotta
Femmina Femmina

CODICE	MISURA	UM	PZ	€
001 022 032	D.25x20x25	PZ	10	1,80



Raccordo PPR Random
a Saldare Gomito 90°
Maschio Femmina

CODICE	MISURA	UM	PZ	€
001 022 037	D.20x20	PZ	10	0,90
001 022 040	D.25x25	PZ	10	1,10



Raccordo PPR Random
a Saldare Riduzione
Femmina Femmina

CODICE	MISURA	UM	PZ	€
001 022 033	D.20x25	PZ	10	0,90
001 022 105	D.32x25	PZ	10	1,50
001 022 106	D.32x20	PZ	10	1,50



Raccordo PPR Random
a Saldare Giunto
Maschio Filettato

CODICE	MISURA	UM	PZ	€
001 022 010	D.20x1/2	PZ	10	4,50
001 022 052	D.20x3/4	PZ	10	7,30
001 022 050	D.25x1/2	PZ	10	7,20
001 022 011	D.25x3/4	PZ	10	7,60
001 022 107	D.32x 1"	PZ	10	15,90



CODICE	MISURA	UM	PZ	€
001 022 012	D.20x1/2	PZ	10	4,40
001 022 051	D.25x1/2	PZ	10	4,80
001 022 013	D.25x3/4	PZ	10	6,70
001 022 108	D.32x 1"	PZ	10	13,20

Raccordo PPR Random
a Saldare
Giunto Femmina Filettato



CODICE	MISURA	UM	PZ	€
001 022 014	D.20x1/2	PZ	10	7,00
001 022 015	D.25x3/4	PZ	10	10,40
001 022 109	D.32x 1"	PZ	10	18,30

Raccordo PPR Random
a Saldare
Tee Maschio Filettato



CODICE	MISURA	UM	PZ	€
001 022 017	D.20x1/2	PZ	10	5,40
001 022 031	D.25x1/2	PZ	10	6,40
001 022 018	D.25x3/4	PZ	10	8,20
001 022 110	D.32x 1"	PZ	10	17,80

Raccordo PPR Random
a Saldare
Tee Femmina Filettato



CODICE	MISURA	UM	PZ	€
001 022 019	D.20x1/2	PZ	10	5,30
001 022 020	D.25x3/4	PZ	10	9,10
001 022 111	D.32x 1"	PZ	10	17,60

Raccordo PPR Random
a Saldare Gomito Maschio
Filettato



CODICE	MISURA	UM	PZ	€
001 022 021	D.20x1/2	PZ	10	4,50
001 022 044	D.25x1/2	PZ	10	6,10
001 022 022	D.25x3/4	PZ	10	7,90
001 022 112	D.32x 1"	PZ	10	15,50

Raccordo PPR Random
a Saldare
Gomito Femmina Filettato



CODICE	MISURA	UM	PZ	€
001 022 023	D.20x1/2	PZ	10	5,20

Raccordo PPR Random
a Saldare Gomito Flangiato
Filettato Femmina



CODICE	MISURA	UM	PZ	€
001 022 025	D.20x20	PZ	10	2,50
001 022 026	D.25x25	PZ	10	3,00
001 022 113	D.32x32	PZ	10	4,40

Raccordo PPR Random
a Saldare Sorpasso



CODICE	MISURA	UM	PZ	€
001 022 049	D.20x20	PZ	10	4,20

Raccordo PPR Random
a Saldare Sorpasso Curva



CODICE	MISURA	UM	PZ	€
001 022 027	D.20x20	PZ	10	21,20
001 022 045	D.25x25	PZ	10	27,80
001 022 114	D.32x32	PZ	10	36,30

Raccordo PPR Random
a Saldare
Rubinetto ad Incasso



CODICE	MISURA	UM	PZ	€
001 022 116	D.1/2	PZ	10	6,80
001 022 117	D.3/4	PZ	10	11,80

Raccordo PPR Random
a Saldare Vitone
per Rubinetto ad Incasso



CODICE	MISURA	UM	PZ	€
001 022 029	D.20	PZ	10	0,70
001 022 038	D.25	PZ	10	0,80
001 022 115	D.32	PZ	10	1,10

Raccordo PPR Random
a Saldare
Tappo Cieco Femmina



CODICE	MISURA	UM	PZ	€
001 022 030	D.20-25-32 - Con Cavalletto	PZ	1	700,90
001 022 034	D.20-25-32 - Con Valigetta	PZ	1	529,00
001 022 035	Matrice D.20	PZ	1	72,10
001 022 036	Matrice D.25	PZ	1	88,60

Polifusore
e Coppie Matrici





SETTORE 001

IDRAULICA



Tubo Polietilene Reticolato Nero UNITHERM

CODICE	MISURA	UM	PZ	€
001 168 004	D.15x2,5	ML	100	1,40
001 168 005	D.18x2,5	ML	100	2,30
001 168 007	D.22X3	ML	100	3,20



Raccordo Giunto Dritto Maschio Polietilene Reticolato - P1

CODICE	MISURA	UM	PZ	€
001 041 050	D.1/2x15	PZ	10	2,90
001 041 051	D.1/2x18	PZ	10	4,00
001 041 079	D.1/2x22	PZ	10	6,30
001 041 052	D.3/4x22	PZ	10	5,80



Raccordo Giunto Dritto Femmina Polietilene Reticolato - P2

CODICE	MISURA	UM	PZ	€
001 041 053	D.1/2x15	PZ	10	3,00
001 041 054	D.1/2x18	PZ	10	4,30
001 041 055	D.3/4x22	PZ	10	5,90



Raccordo Gomito Maschio Polietilene Reticolato - P5

CODICE	MISURA	UM	PZ	€
001 041 056	D.1/2x15	PZ	10	4,20
001 041 057	D.1/2x18	PZ	10	4,90
001 041 081	D.1/2x22	PZ	10	7,90
001 041 058	D.3/4x22	PZ	10	7,90



Raccordo Giunto Doppio Ridotto Polietilene Reticolato - P3

CODICE	MISURA	UM	PZ	€
001 041 073	D.15x15	PZ	10	5,50
001 041 074	D.18x18	PZ	10	6,70
001 041 075	D.22x22	PZ	10	9,80



Raccordo Gomito Doppio Polietilene Reticolato - P6

CODICE	MISURA	UM	PZ	€
001 041 077	D.15x15	PZ	10	3,40
001 041 043	D.18x18	PZ	10	8,80
001 041 078	D.22x22	PZ	10	6,80



Raccordo Gomito Femmina Polietilene Reticolato - P4

CODICE	MISURA	UM	PZ	€
001 041 059	D.1/2x15	PZ	10	4,20
001 041 060	D.1/2x18	PZ	10	6,70
001 041 061	D.3/4x22	PZ	10	5,30

CODICE	MISURA	UM	PZ	€
001 041 065	D.15x1/2x15x2,5	PZ	10	6,60
001 041 066	D.18x1/2x18x2,5	PZ	10	10,30
001 041 067	D.22x3/4x22x3	PZ	10	11,80

Raccordo Tee Femmina
Polietilene Reticolato - P8



CODICE	MISURA	UM	PZ	€
001 041 080	D.15x1/2x15x2,5	PZ	10	6,20
001 041 096	D.18x1/2x18x2,5	PZ	10	5,80
001 041 095	D.22x3/4x22x3	PZ	10	12,30

Raccordo Tee Maschio
Polietilene Reticolato - P7



CODICE	MISURA	UM	PZ	€
001 041 062	D.15x15x15x2,5	PZ	10	8,30
001 041 063	D.18x18x18x2,5	PZ	10	12,20
001 041 064	D.22x22x22x2,5	PZ	10	9,20

Raccordo Tee 3 Dadi
Polietilene Reticolato - P9



CODICE	MISURA	UM	PZ	€
001 041 068	D.1/2x15	PZ	10	5,00
001 041 069	D.1/2x18	PZ	10	7,00

Raccordo Gomito Femmina
Flangiato Polietilene
Reticolato - P10



CODICE	MISURA	UM	PZ	€
001 041 076	Completa di 4 viti e dadi	PZ	10	4,40

Piastra per Fissaggio
Gomiti Flangiati



CODICE	MISURA	UM	PZ	€
001 041 070	D.15	PZ	10	1,30
001 041 071	D.18	PZ	10	1,70
001 041 072	D.22	PZ	10	1,30

Curva Reggitubo per Tubo
Polietilene Reticolato - S1





Valvola Scaldacqua Boiler Cromata

CODICE	MISURA	UM	PZ	€
001 064 002	D.3/8 MF 8,5-1	PZ	10	3,30
001 064 003	D.1/2 MF 8,5-1	PZ	10	4,30



Valvola Scaldacqua Boiler Rinforzata Cromata

CODICE	MISURA	UM	PZ	€
001 064 004	D.1/2 MF	PZ	10	9,00



Gruppo di Sicurezza Idraulico Sotto Boiler

CODICE	MISURA	UM	PZ	€
001 107 009	D.1/2	PZ	10	38,80



Rosetta Esagonale Acciaio Cromata

CODICE	MISURA	UM	PZ	€
001 071 015	D.3/8	PZ	10	0,40
001 071 016	D.1/2	PZ	10	0,40



Rosetta Tonda Acciaio Cromata

CODICE	MISURA	UM	PZ	€
001 072 013	D.3/8	PZ	10	0,30
001 072 014	D.1/2	PZ	10	0,30



Tappo Maschio con Rosone Cromato

CODICE	MISURA	UM	PZ	€
001 170 211	D.1/2	PZ	10	2,10



Contatore Acqua Asciutto **Bosco** Completo Raccordi e Bollo

CODICE	MISURA	UM	PZ	€
001 081 010	D.1/2	PZ	1	49,50
001 081 011	D.3/4	PZ	1	69,10
001 081 012	D.1"	PZ	1	119,90



Contatore Acqua Asciutto **Itron** Completo Raccordi e Bollo

CODICE	MISURA	UM	PZ	€
001 081 017	D.1/2	PZ	1	41,30
001 081 018	D.3/4	PZ	1	61,00
001 081 013	D.1"1/4	PZ	1	269,30
001 081 014	D.1"1/2	PZ	1	436,30
001 081 015	D.2"	PZ	1	548,60



Contatore Acqua Asciutto **Sisma** Completo Raccordi e Bollo

CODICE	MISURA	UM	PZ	€
001 093 010	D.1/2	PZ	25	34,60
001 093 011	D.3/4	PZ	18	42,70



Contatore Acqua Bagnato **Sisma** Completo Raccordi e Bollo

CODICE	MISURA	UM	PZ	€
001 093 001	D.1/2	PZ	10	31,70



Raccordo per Contatore Acqua Completo Ottone Giallo

CODICE	MISURA	UM	PZ	€
001 081 007	D.3/8	PZ	10	2,20
001 081 006	D.1/2	PZ	10	3,80
001 081 008	D.3/4	PZ	5	6,50



CODICE	MISURA	UM	PZ	€
001 091 001	D.1/2	PZ	1	33,70

Riduttore di Pressione Acqua Sotto Boiler Sabo PN 10



CODICE	MISURA	UM	PZ	€
001 091 004	D.1/2	PZ	1	44,30
001 091 002	D.3/4	PZ	1	52,30
001 091 003	D.1"	PZ	1	80,60

Riduttore di Pressione Acqua Per Linee PN 25 Serie Normale Senza Bocchettone



CODICE	MISURA	UM	PZ	€
001 091 026	D.1/2	PZ	1	51,70
001 091 027	D.3/4	PZ	1	64,20
001 091 028	D.1"	PZ	1	98,20

Riduttore di Pressione Acqua Per Linee PN 25 Serie Normale Con Bocchettone



CODICE	MISURA	UM	PZ	€
001 091 022	D.1/2	PZ	1	105,30
001 091 023	D.3/4	PZ	1	174,60
001 091 025	D.1"	PZ	1	243,90

Riduttore di Pressione Acqua Per Linee PN 40 Serie Inox Con Bocchettone



CODICE	MISURA	UM	PZ	€
001 100 001	D.1/2	PZ	1	135,20
001 100 002	D.3/4	PZ	1	154,60

Riduttore di Pressione Acqua Per Linee PN 30 a Membrana Con Bocchettone - RB



CODICE	MISURA	UM	PZ	€
001 100 004	D.1/2	PZ	1	67,10
001 100 005	D.3/4	PZ	1	98,10
001 100 006	D.1"	PZ	1	125,70

Riduttore di Pressione Acqua Per Linee PN 40 a Pistone Senza Bocchettone - RB



CODICE	MISURA	UM	PZ	€
001 091 020	D.3/4	PZ	1	25,20

Valvola di Sicurezza ad Angolo con Molla Sede Metallica



CODICE	MISURA	UM	PZ	€
001 091 019	D.1"	PZ	1	124,00

Valvola di Sfiato Tipo Roma Ottone Giallo



CODICE	MISURA	UM	PZ	€
001 091 034	D.1/2	PZ	1	13,00
001 091 035	D.3/4	PZ	1	13,00
001 091 036	D.1"	PZ	1	13,00

Kit Guarnizioni per Riduttore Pressione O.R. PN 40





Rubinetto Snodo con Filtro
Sotto Lavabo Pesante
Albertoni

CODICE	MISURA	UM	PZ	€
001 094 001	D.1/2x10	PZ	10	8,90



Rubinetto Snodo con Filtro
Sotto Lavabo Leggero

CODICE	MISURA	UM	PZ	€
001 094 044	D.1/2x10	PZ	10	7,90



Rubinetto Senza Filtro
per Cassetta Cromato

CODICE	MISURA	UM	PZ	€
001 094 003	D.1/2x10	PZ	10	8,00



Rubinetto con Filtro
Sotto Lavabo Arredo Linea
Albertoni

CODICE	MISURA	UM	PZ	€
001 094 095	D.1/2x10	PZ	10	42,70



Rubinetto Lavatrice Sfera
Cromato Pesante

CODICE	MISURA	UM	PZ	€
001 094 011	D.1/2x3/4	PZ	10	7,00



Rubinetto Lavatrice Sfera
Cromato Leggero

CODICE	MISURA	UM	PZ	€
001 141 003	D.1/2x3/4	PZ	10	6,50



Rubinetto Lavatrice Vitone
Cromato

CODICE	MISURA	UM	PZ	€
001 094 092	D.1/2x3/4 ITAP	PZ	10	8,90



Rubinetto Combinato Sotto
Lavabo e Lavatrice Cromato

CODICE	MISURA	UM	PZ	€
001 094 006	D.1/2x10x3/4	PZ	10	20,20



Rubinetto 3 Vie Sotto Lavabo
Lavatrice

CODICE	MISURA	UM	PZ	€
001 094 043	D.1/2x3/4x1/2	PZ	10	11,80



CODICE	MISURA	UM	PZ	€
001 094 004	D.1/2x10	PZ	10	7,40

Curvetta Esagonale Sotto Lavabo Cromato



CODICE	MISURA	UM	PZ	€
001 094 045	D.1/2x10	PZ	10	6,30

Curvetta Esagonale Allungabile Sotto Lavabo Leggera



CODICE	MISURA	UM	PZ	€
001 094 028	D.1/2x10	PZ	10	7,30

Curvetta Esagonale Allungabile Sotto Lavabo Pesante



CODICE	MISURA	UM	PZ	€
001 094 048	D.1/2	PZ	10	3,20

Angolo Doccia Presa Acqua con Rosetta Cromato Leggero



CODICE	MISURA	UM	PZ	€
001 094 009	D.1/2	PZ	10	6,00

Angolo Doccia Presa Acqua con Rosetta Cromato Pesante



CODICE	MISURA	UM	PZ	€
001 094 046	D.54	PZ	10	1,90

Tappo Copriforo Cromato Leggero



CODICE	MISURA	UM	PZ	€
001 094 008	D.54	PZ	10	9,00

Tappo Copriforo Cromato Pesante





Cannetta Cromata di Rame con Dado

CODICE	MISURA	UM	PZ	€
001 094 014	D.1/2x10x20	PZ	20	3,20
001 094 015	D.1/2x10x25	PZ	20	3,10
001 094 016	D.1/2x10x30	PZ	20	4,30
001 094 017	D.1/2x10x35	PZ	20	4,60
001 094 018	D.1/2x10x40	PZ	20	5,40
001 094 062	D.1/2x10x50	PZ	20	6,00
001 094 063	D.1/2x10x60	PZ	20	6,80
001 094 064	D.1/2x10x80	PZ	20	8,40
001 094 019	D.1/2x10x100	PZ	20	10,70



Cannetta Cromata di Rame con Dado

CODICE	MISURA	UM	PZ	€
001 094 060	D.3/8x10x20	PZ	20	3,10
001 094 002	D.3/8x10x30	PZ	20	4,20
001 094 005	D.3/8x10x35	PZ	20	4,50
001 094 010	D.3/8x10x40	PZ	20	4,70
001 094 061	D.3/8x10x50	PZ	20	5,90
001 094 066	D.3/8x10x60	PZ	20	6,10
001 094 067	D.3/8x10x80	PZ	20	8,30



Dado Ottone Cromato per Cannette

CODICE	MISURA	UM	PZ	€
001 094 056	D.1/2	PZ	10	0,70
001 094 057	D.3/8	PZ	10	0,70



Cannetta Prolunga Cromata di Rame

CODICE	MISURA	UM	PZ	€
001 094 041	D.10x10x30	PZ	10	5,40
001 094 042	D.10x10x40	PZ	10	6,50



Cannetta Filettata per Miscelatore Cromata di Rame

CODICE	MISURA	UM	PZ	€
001 094 050	D.1/4x10x30	PZ	20	3,50
001 094 051	D.1/4x10x40	PZ	20	4,70



Cannetta Prolunga per Miscelatore Cromata di Rame

CODICE	MISURA	UM	PZ	€
001 094 070	D.M10x40	PZ	20	4,80
001 094 071	D.M10x250	PZ	20	3,60



Rosone a Campanello Acciaio Innox

CODICE	MISURA	UM	PZ	€
001 094 020	D.10	PZ	10	0,60



Adattatore Cannetta per Rubinetteria Mix

CODICE	MISURA	UM	PZ	€
001 094 074	F10 x M8	PZ	10	3,10
001 094 075	F10 x M9	PZ	10	3,10
001 094 076	F10 x M11	PZ	10	3,10
001 094 077	F10 x M12	PZ	10	3,10



CODICE	MISURA	UM	PZ	€
001 094 013	D.14x10	PZ	10	45,00

Completo Boiler
Rubinetto Cannette
e Raccordi



CODICE	MISURA	UM	PZ	€
001 094 012	D.1/2x10	PZ	10	14,20

Completo per Cassetta
Rubinetto Cannette
e Raccordi



CODICE	MISURA	UM	PZ	€
001 094 007	D.10x5	PZ	10	55,20

Rotolo Tubo Cromato
in Rame Cotto per Cannette



CODICE	MISURA	UM	PZ	€
001 094 090	D.3/8	PZ	10	5,70

Tubo Cromato a J in Rame
per Cassetta con Calotta



CODICE	MISURA	UM	PZ	€
001 094 053	D.1/2x10	PZ	10	5,60

Gomito con Flangia
Femmina Cromato



CODICE	MISURA	UM	PZ	€
001 094 027	D.1/2x10	PZ	25	2,70
001 094 029	D.3/8x10	PZ	25	2,20

Raccordo per Cannetta
Maschio Cromato



CODICE	MISURA	UM	PZ	€
001 094 031	D.1/2x10	PZ	25	2,80
001 094 030	D.3/8x10	PZ	25	50,30

Raccordo per Cannetta
Femmina Cromato



CODICE	MISURA	UM	PZ	€
001 094 034	D.10x10	PZ	25	3,50

Raccordo per Cannetta
Giunzione Cromato





Aeratore Snodo Regolabile
2 Funzione Maschio

CODICE	MISURA	UM	PZ	€
001 094 080	D.22x1	PZ	10	2,80



Aeratore Prolungato
Regolabile 2 Funzione Nero
Cromo Femmina gomma

CODICE	MISURA	UM	PZ	€
001 094 081	Nero	PZ	10	3,90



Aeratore Maschio Cromato
Lavabo

CODICE	MISURA	UM	PZ	€
001 094 021	D.24/1	PZ	10	0,70



Aeratore Maschio Cromato
Maschio Vasca

CODICE	MISURA	UM	PZ	€
001 094 040	D.28/1	PZ	10	1,10



Aeratore Femmina
Cromato

CODICE	MISURA	UM	PZ	€
001 094 022	D.22/1	PZ	10	0,70



Aeratore Snodo Femmina
Cromato

CODICE	MISURA	UM	PZ	€
001 094 024	D. 1/2	PZ	10	3,90



Aeratore Snodo Maschio
Cromato

CODICE	MISURA	UM	PZ	€
001 094 023	D. 1/2	PZ	10	3,30



Aeratore Neoperl Perlator LL
Femmina Cromato C/Filetto

CODICE	MISURA	UM	PZ	€
001 094 082	D.22/1	PZ	10	1,90



CODICE	MISURA	UM	PZ	€
001 094 084	D.24/1	PZ	10	1,90

Aeratore Neoperl Perlator LL
Maschio Cromato C/Filetto



CODICE	MISURA	UM	PZ	€
001 094 085	D.28/1	PZ	10	3,50

Aeratore Neoperl Perlator LL
Maschio Cromato C/Filetto



CODICE	MISURA	UM	PZ	€
001 094 086	D.22/1	PZ	10	7,10

Aeratore Neoperl SSR con
Snodo Incorporato Maschio
Cromato



CODICE	MISURA	UM	PZ	€
001 094 087	D.24/1	PZ	10	7,10

Aeratore Neoperl SSR con
Snodo Incorporato Maschio
Cromato



CODICE	MISURA	UM	PZ	€
001 101 010	D.3/4x3/4	PZ	10	12,60

Distanziali per Gruppi
Parete Cromati Coppia Cieco
e Forato



CODICE	MISURA	UM	PZ	€
001 101 008	D.3/4x3/4	PZ	10	6,30

Distanziali per Gruppi Parete
Cromati Cieco



CODICE	MISURA	UM	PZ	€
001 101 009	D.3/4x3/8	PZ	10	12,20

Distanziali per Gruppi Parete
Cromati Forato



CODICE	MISURA	UM	PZ	€
001 101 105	D.1/2x3/4	PZ	10	2,90

Eccentrico per Gruppi Parete
Cromato Coppia Normale



CODICE	MISURA	UM	PZ	€
001 101 104	D.1/2x3/4 Cm 4	PZ	10	9,50
001 101 106	D.1/2x3/4 Cm 6	PZ	10	11,10
001 101 107	D.1/2x3/4 Cm 8	PZ	10	12,90
001 101 108	D.1/2x3/4 Cm 10	PZ	10	19,60

Eccentrico per Gruppi Parete
Cromato Prolungato





Resistenza Scaldacqua Lunga Attacco a Vite

CODICE	MISURA	UM	PZ	€
001 107 001	1200 Watt	PZ	10	14,10



Resistenza Scaldacqua Lunga Attacco Flangiato

CODICE	MISURA	UM	PZ	€
001 107 003	1200 Watt	PZ	10	12,30



Resistenza Scaldacqua Lunga Attacco a Vite Ripiegata

CODICE	MISURA	UM	PZ	€
001 107 002	1200 Watt	PZ	10	14,90



Resistenza Scaldacqua Lunga Attacco Flangiato Ripiegata

CODICE	MISURA	UM	PZ	€
001 107 006	1200 Watt	PZ	10	12,80



Resistenza Scaldacqua Ariston Lunga Attacco Flangiato

CODICE	MISURA	UM	PZ	€
001 107 007	1200 Watt	PZ	10	13,50



Resistenza Scaldacqua Ariston Ripiegata Attacco Flangiato

CODICE	MISURA	UM	PZ	€
001 107 008	1200 Watt	PZ	10	13,90



Termostato Scaldacqua Lungo Universale per Grandi Litraggi

CODICE	MISURA	UM	PZ	€
001 107 005		PZ	10	8,40



Termostato Scaldacqua Ariston Lungo Universale per Grandi Litraggi

CODICE	MISURA	UM	PZ	€
001 107 011		PZ	10	17,60



Termostato Scaldacqua Ariston Regg. Universale per Piccoli Litraggi

CODICE	MISURA	UM	PZ	€
001 107 012		PZ	10	24,10



Gruppo di Sicurezza Idraulico Sotto Boiler

CODICE	MISURA	UM	PZ	€
001 107 009	D.1/2	PZ	10	38,80

CODICE	MISURA	UM	PZ	€
001 098 105	D.3/8	PZ	10	1,30
001 098 001	D.1/2	PZ	10	0,90
001 098 002	D.3/4	PZ	10	1,50
001 098 003	D.1"	PZ	10	2,20
001 098 004	D.1"1/4	PZ	10	4,10
001 098 005	D.1"1/2	PZ	10	6,60
001 098 006	D.2"	PZ	10	7,80
001 098 074	D.2"1/2	PZ	10	22,60
001 098 075	D.3"	PZ	10	31,00
001 098 076	D.4"	PZ	10	53,90

Raccordo Ghisa Zincato
Gomito Femmina Femmina
Fig. 90



CODICE	MISURA	UM	PZ	€
001 098 106	D.3/8	PZ	10	1,50
001 098 007	D.1/2	PZ	10	1,10
001 098 008	D.3/4	PZ	10	1,70
001 098 009	D.1"	PZ	10	2,80
001 098 010	D.1"1/4	PZ	10	4,80
001 098 011	D.1"1/2	PZ	10	7,20
001 098 012	D.2"	PZ	10	9,40
001 098 073	D.2"1/2	PZ	10	21,60
001 098 077	D.3"	PZ	10	28,40
001 098 078	D.4"	PZ	10	52,50

Raccordo Ghisa Zincato
Gomito Maschio Femmina
Fig. 92



CODICE	MISURA	UM	PZ	€
001 098 107	D.3/8	PZ	10	1,80
001 098 013	D.1/2	PZ	10	1,30
001 098 014	D.3/4	PZ	10	2,20
001 098 015	D.1"	PZ	10	3,10
001 098 016	D.1"1/4	PZ	10	5,60
001 098 017	D.1"1/2	PZ	10	8,60
001 098 018	D.2"	PZ	10	12,10
001 098 079	D.2"1/2	PZ	10	26,30
001 098 080	D.3"	PZ	10	35,80
001 098 081	D.4"	PZ	10	84,60

Raccordo Ghisa Zincato
Tee Femmina Femmina
Fig. 130



CODICE	MISURA	UM	PZ	€
001 098 108	D.3/8	PZ	10	1,30
001 098 037	D.1/2	PZ	10	1,10
001 098 038	D.3/4	PZ	10	1,50
001 098 039	D.1"	PZ	10	1,90
001 098 040	D.1"1/4	PZ	10	3,00
001 098 041	D.1"1/2	PZ	10	4,30
001 098 042	D.2"	PZ	10	6,30
001 098 094	D.2"1/2	PZ	10	16,20
001 098 095	D.3"	PZ	10	21,00
001 098 096	D.4"	PZ	10	47,50

Raccordo Ghisa Zincato
Manicotto
Femmina Femmina
Fig. 270





Raccordo Ghisa Zincato
Niples Maschio Maschio
Fig. 280

CODICE	MISURA	UM	PZ	€
001 098 109	D.3/8	PZ	10	1,80
001 098 043	D.1/2	PZ	10	1,00
001 098 044	D.3/4	PZ	10	1,30
001 098 045	D.1"	PZ	10	1,80
001 098 046	D.1"1/4	PZ	10	3,00
001 098 047	D.1"1/2	PZ	10	3,50
001 098 048	D.2"	PZ	10	6,20
001 098 082	D.2"1/2	PZ	10	11,10
001 098 083	D.3"	PZ	10	12,30
001 098 084	D.4"	PZ	10	49,00



Raccordo Ghisa Zincato
Bocchettone Conico
Femmina Femmina
Fig. 340

CODICE	MISURA	UM	PZ	€
001 098 051	D.1/2	PZ	10	4,70
001 098 052	D.3/4	PZ	10	5,30
001 098 053	D.1"	PZ	10	6,20
001 098 054	D.1"1/4	PZ	10	10,60
001 098 055	D.1"1/2	PZ	10	12,40
001 098 056	D.2"	PZ	10	18,80
001 098 088	D.2"1/2	PZ	10	42,50
001 098 089	D.3"	PZ	10	59,30
001 098 090	D.4"	PZ	10	147,40



Raccordo Ghisa Zincato
Tappo Maschio
Fig.290

CODICE	MISURA	UM	PZ	€
001 098 057	D.3/8	PZ	10	0,70
001 098 058	D.1/2	PZ	10	0,80
001 098 059	D.3/4	PZ	10	1,00
001 098 060	D.1"	PZ	10	1,10
001 098 061	D.1"1/4	PZ	10	2,10
001 098 062	D.1"1/2	PZ	10	2,50
001 098 063	D.2"	PZ	10	4,50
001 098 085	D.2"1/2	PZ	10	9,00
001 098 086	D.3"	PZ	10	12,10
001 098 087	D.4"	PZ	10	19,50



Raccordo Ghisa Zincato
Tee Croce Femmina Femmina
Fig.180

CODICE	MISURA	UM	PZ	€
001 098 069	D.1/2	PZ	10	4,10
001 098 070	D.3/4	PZ	10	6,10
001 098 068	D.1"	PZ	10	7,80
001 098 067	D.1"1/4	PZ	10	10,10
001 098 097	D.1"1/2	PZ	10	13,50

CODICE	MISURA	UM	PZ	€
001 098 033	D.1/2 x3/8	PZ	10	1,00
001 098 032	D.3/4 x1/2	PZ	10	1,00
001 098 071	D.1" x3/8	PZ	10	1,80
001 098 031	D.1" x1/2	PZ	10	1,40
001 098 030	D.1" x3/4	PZ	10	1,30
001 098 072	D.1"1/4x3/8	PZ	10	4,30
001 098 029	D.1"1/4x1/2	PZ	10	2,40
001 098 028	D.1"1/4x3/4	PZ	10	2,20
001 098 027	D.1"1/4x1"	PZ	10	1,60
001 098 026	D.1"1/2x1/2	PZ	10	3,20
001 098 025	D.1"1/2x3/4	PZ	10	3,50
001 098 024	D.1"1/2x1"	PZ	10	2,40
001 098 023	D.1"1/2x1"1/4	PZ	10	2,40
001 098 022	D.2" x1/2	PZ	10	6,10
001 098 021	D.2" x3/4	PZ	10	5,80
001 098 020	D.2" x1"	PZ	10	5,20
001 098 064	D.2" x1"1/4	PZ	10	5,00
001 098 019	D.2" x1"1/2	PZ	10	4,40
001 098 091	D.2"1/2x2"	PZ	10	8,50
001 098 098	D.3" x1"	PZ	10	15,90
001 098 099	D.3" x2"	PZ	10	10,90
001 098 092	D.3" x2"1/2	PZ	10	12,40
001 098 104	D.4" x2"	PZ	10	29,30
001 098 093	D.4" x3"	PZ	10	20,90

Raccordo Ghisa Zincato
Riduzione Maschio Femmina
Fig.241



SETTORE 001

IDRAULICA

CODICE	MISURA	UM	PZ	€
001 098 110	D.1/2	PZ	10	2,60
001 098 111	D.3/4	PZ	10	4,00
001 098 112	D.1"	PZ	10	5,90
001 098 113	D.1"1/4	PZ	10	9,60
001 098 114	D.1"1/2	PZ	10	11,70
001 098 115	D.2"	PZ	10	16,30
001 098 116	D.2"1/2	PZ	10	45,10
001 098 117	D.3"	PZ	10	56,60
001 098 118	D.4"	PZ	10	107,30

Raccordo Ghisa Zincato
Curva Lunga
Femmina Femmina
Fig.2



CODICE	MISURA	UM	PZ	€
001 098 120	D.1/2	PZ	10	2,40
001 098 121	D.3/4	PZ	10	4,10
001 098 122	D.1"	PZ	10	5,30
001 098 123	D.1"1/4	PZ	10	9,50
001 098 124	D.1"1/2	PZ	10	12,60
001 098 125	D.2"	PZ	10	20,20
001 098 126	D.2"1/2	PZ	10	44,50
001 098 127	D.3"	PZ	10	57,50
001 098 128	D.4"	PZ	10	104,30

Raccordo Ghisa Zincato
Curva Lunga
Maschio Femmina
Fig.1





SETTORE 001
IDRAULICA



Raccordo Ghisa Zincato
Curva Lunga 45°
Femmina Femmina
Fig.41

CODICE	MISURA	UM	PZ	€
001 098 130	D.1/2	PZ	10	3,50
001 098 131	D.3/4	PZ	10	4,00
001 098 132	D.1"	PZ	10	5,70
001 098 133	D.1"1/4	PZ	10	10,10
001 098 134	D.1"1/2	PZ	10	12,30
001 098 135	D.2"	PZ	10	18,20
001 098 136	D.2"1/2	PZ	10	32,80
001 098 137	D.3"	PZ	10	41,80
001 098 138	D.4"	PZ	10	93,00



Raccordo Ghisa Zincato
Curva Lunga 45°
Maschio Femmina
Fig.40

CODICE	MISURA	UM	PZ	€
001 098 140	D.1/2	PZ	10	3,00
001 098 141	D.3/4	PZ	10	3,60
001 098 142	D.1"	PZ	10	5,60
001 098 143	D.1"1/4	PZ	10	9,40
001 098 144	D.1"1/2	PZ	10	10,30
001 098 145	D.2"	PZ	10	16,10
001 098 146	D.2"1/2	PZ	10	35,80
001 098 147	D.3"	PZ	10	39,10
001 098 148	D.4"	PZ	10	88,10



Raccordo Ghisa Zincato
Manicotto
Maschio Femmina
Fig.529

CODICE	MISURA	UM	PZ	€
001 098 235	D.1/2	PZ	10	2,10
001 098 236	D.3/4	PZ	10	3,10
001 098 065	D.1"	PZ	10	7,50
001 098 066	D.1"1/4	PZ	10	5,20
001 098 237	D.1"1/2	PZ	10	9,50
001 098 238	D.2"	PZ	10	21,40



Raccordo Ghisa Zincato
Sorpasso
Femmina Femmina
Fig.85

CODICE	MISURA	UM	PZ	€
001 098 049	D.1/2	PZ	10	3,50
001 098 050	D.3/4	PZ	10	7,00



Raccordo Ghisa Zincato
Gomito Ridotto
Maschio Femmina
Fig.92R

CODICE	MISURA	UM	PZ	€
001 098 170	D.1/2 x3/8	PZ	10	3,40
001 098 171	D.3/4 x1/2	PZ	10	7,40
001 098 172	D.1" x3/4	PZ	10	9,60
001 098 173	D.1"1/4x1"	PZ	10	13,90
001 098 174	D.1"1/2x1"	PZ	10	19,80
001 098 175	D.1"1/2x1"1/4	PZ	10	14,50
001 098 176	D.3/8 x1/2	PZ	10	4,50
001 098 177	D.1/2 x3/4	PZ	10	9,20
001 098 178	D.3/4 x1	PZ	10	13,30
001 098 179	D.1" x1"1/4	PZ	10	20,80

CODICE	MISURA	UM	PZ	€
001 098 150	D.1/2 x3/8	PZ	10	2,80
001 098 151	D.3/4 x1/2	PZ	10	1,80
001 098 152	D.1" x1/2	PZ	10	2,90
001 098 153	D.1" x3/4	PZ	10	3,00
001 098 154	D.1"1/4x1/2	PZ	10	4,60
001 098 155	D.1"1/4x3/4	PZ	10	5,90
001 098 156	D.1"1/4x1"	PZ	10	4,90
001 098 157	D.1"1/2x3/4	PZ	10	7,00
001 098 158	D.1"1/2x1"	PZ	10	6,30
001 098 159	D.1"1/2x1"1/4	PZ	10	7,00
001 098 160	D.2" x1"	PZ	10	20,90
001 098 161	D.2" x1"1/4	PZ	10	11,80
001 098 162	D.2" x1"1/2	PZ	10	11,20
001 098 163	D.2"1/2x2"	PZ	10	32,30

Raccordo Ghisa Zincato
Gomito Ridotto
Femmina Femmina
Fig.90R



CODICE	MISURA	UM	PZ	€
001 098 185	D.1/2 x3/8	PZ	10	2,20
001 098 186	D.3/4 x1/2	PZ	10	1,90
001 098 187	D.1" x1/2	PZ	10	3,90
001 098 188	D.1" x3/4	PZ	10	2,20
001 098 189	D.1"1/4x1/2	PZ	10	10,20
001 098 190	D.1"1/4x3/4	PZ	10	8,00
001 098 191	D.1"1/4x1"	PZ	10	3,40
001 098 192	D.1"1/2x3/4	PZ	10	8,50
001 098 193	D.1"1/2x1"	PZ	10	7,90
001 098 194	D.1"1/2x1"1/4	PZ	10	4,40
001 098 195	D.2" x1"	PZ	10	11,60
001 098 196	D.2" x1"1/4	PZ	10	8,50
001 098 197	D.2" x1"1/2	PZ	10	7,70
001 098 198	D.2"1/2x1"1/2	PZ	10	19,60
001 098 199	D.2"1/2x2"	PZ	10	18,50
001 098 200	D.3" x2"	PZ	10	22,20
001 098 201	D.4" x3"	PZ	10	54,50

Raccordo Ghisa Zincato
Niples Ridotto
Maschio Maschio
Fig.245



CODICE	MISURA	UM	PZ	€
001 098 225	D.1/2	PZ	10	4,60
001 098 226	D.3/4	PZ	10	5,40
001 098 227	D.1"	PZ	10	6,90
001 098 228	D.1"1/4	PZ	10	10,40
001 098 229	D.1"1/2	PZ	10	14,00
001 098 230	D.2"	PZ	10	22,30
001 098 231	D.2"1/2	PZ	10	46,40
001 098 232	D.3"	PZ	10	67,50
001 098 233	D.4"	PZ	10	123,80

Raccordo Ghisa Zincato
Bocchettone Conico
Maschio Femmina
Fig.341



CODICE	MISURA	UM	PZ	€
001 017 020	D.3/4	PZ	10	32,60
001 017 021	D.1"	PZ	10	35,40
001 017 022	D.1"1/4	PZ	10	44,50
001 017 023	D.1"1/2	PZ	10	51,60
001 017 024	D.2"	PZ	10	65,50
001 017 025	D.2"1/2	PZ	10	108,90
001 017 026	D.3"	PZ	10	147,10

Giunto Elastico
di Compensazione
Antivibrante Zincato





SETTORE 001
IDRAULICA



Tubo Zincato a Barre
Saldato per Acqua e Gas

CODICE	MISURA	UM	PZ	€
001 103 005	D.1/2	ML	6	5,00
001 103 006	D.3/4	ML	6	6,10
001 103 007	D.1"	ML	6	9,20
001 103 008	D.1"1/4	ML	6	11,80
001 103 009	D.1"1/2	ML	6	13,60
001 103 010	D.2"	ML	6	18,80
001 103 011	D.2"1/2	ML	6	23,50
001 103 012	D.3"	ML	6	30,40



Tubo Zincato a Barre
Saldato per Acqua e Gas

CODICE	MISURA	UM	PZ	€
001 103 025	D.1/2	ML	3	6,90
001 103 026	D.3/4	ML	3	8,50
001 103 027	D.1"	ML	3	13,00
001 103 028	D.1"1/4	ML	3	16,60
001 103 029	D.1"1/2	ML	3	19,10
001 103 030	D.2"	ML	3	26,40
001 103 031	D.2"1/2	ML	3	33,80
001 103 032	D.3"	ML	3	44,50



Raccordo Ghisa Zincato
Manicotto Ridotto
Maschio Femmina
Fig.246

CODICE	MISURA	UM	PZ	€
001 098 241	D.3/4 x1/2	PZ	10	2,00
001 098 242	D.1" x3/4	PZ	10	3,10
001 098 243	D.1" x1/2	PZ	10	3,00
001 098 244	D.1"1/4x1"	PZ	10	3,50
001 098 245	D.1"1/2x1"1/4	PZ	10	5,50
001 098 246	D.2" x1"1/2	PZ	10	9,80



Raccordo Ghisa Zincato
Manicotto Ridotto
Femmina Femmina
Fig.240

CODICE	MISURA	UM	PZ	€
001 098 260	D.1/2 x3/8	PZ	10	1,50
001 098 261	D.3/4 x1/2	PZ	10	1,90
001 098 262	D.1" x1/2	PZ	10	2,40
001 098 263	D.1" x3/4	PZ	10	2,20
001 098 264	D.1"1/4x1/2	PZ	10	4,30
001 098 265	D.1"1/4x3/4	PZ	10	3,80
001 098 266	D.1"1/4x1"	PZ	10	3,90
001 098 267	D.1"1/2x1"	PZ	10	4,40
001 098 268	D.1"1/2x1"1/4	PZ	10	4,70
001 098 269	D.2" x1"	PZ	10	9,20
001 098 270	D.2" x1"1/4	PZ	10	6,90
001 098 271	D.2" x1"1/2	PZ	10	7,30
001 098 272	D.2"1/2x2"	PZ	10	19,10
001 098 273	D.3" x2"	PZ	10	31,00
001 098 274	D.4" x3"	PZ	10	57,50



CODICE	MISURA	UM	PZ	€
001 099 041	D.1/4	PZ	10	0,70
001 099 039	D.3/8	PZ	10	0,70
001 099 040	D.1/2	PZ	10	0,80
001 099 023	D.3/4	PZ	10	1,30
001 099 079	D.1"	PZ	10	2,80
001 099 084	D.1"1/4	PZ	10	4,70

Raccordo Acciaio Zincato
Tappo Maschio
Fig.292



CODICE	MISURA	UM	PZ	€
001 099 056	D.3/8	PZ	10	0,90
001 099 073	D.1/2	PZ	10	1,00
001 099 071	D.3/4	PZ	10	1,40
001 099 057	D.1"	PZ	10	4,90
001 099 083	D.1"1/4	PZ	10	6,90

Raccordo Acciaio Zincato
Tappo Femmina
Fig.300



CODICE	MISURA	UM	PZ	€
001 099 016	D.3/8x10	PZ	0	0,80
001 099 017	D.1/2x10	PZ	10	0,70
001 099 018	D.1/2x15	PZ	10	0,70
001 099 019	D.1/2x20	PZ	10	0,90
001 099 061	D.1/2x30	PZ	10	1,40
001 099 020	D.1/2x50	PZ	10	2,90
001 099 114	D.3/4x10	PZ	10	1,50
001 099 062	D.3/4x15	PZ	10	1,30
001 099 030	D.3/4x20	PZ	10	1,70
001 099 063	D.3/4x30	PZ	10	2,50
001 099 031	D.3/4x50	PZ	10	4,20
001 099 113	D.1" x10	PZ	10	3,00
001 099 064	D.1" x20	PZ	10	3,80
001 099 065	D.1" x30	PZ	10	6,10
001 099 021	D.1" x50	PZ	10	7,20

Raccordo Acciaio Zincato
Prolunga Maschio Femmina
Fig.529



CODICE	MISURA	UM	PZ	€
001 099 028	D.3/8 x1/4	PZ	10	0,80
001 099 034	D.1/2 x3/8	PZ	10	0,90
001 099 088	D.3/4 x3/8	PZ	10	1,30
001 099 035	D.3/4 x1/2	PZ	10	1,30
001 099 036	D.1" x3/4	PZ	10	2,60
001 099 085	D.1" x1/2	PZ	10	2,90
001 099 055	D.1"1/4x1"	PZ	10	5,90

Raccordo Acciaio Zincato
Riduzione Maschio Femmina
Fig.241



CODICE	MISURA	UM	PZ	€
001 099 070	D.3/8 x1/4	PZ	10	1,30
001 099 022	D.1/2 x3/8	PZ	10	1,20
001 099 032	D.3/4 x1/2	PZ	10	1,90
001 099 069	D.1" x3/4	PZ	10	3,30
001 099 091	D.1" x1/2	PZ	10	4,20
001 099 094	D.1"1/4x1"	PZ	10	9,70

Raccordo Acciaio Zincato
Prolunga Ridotta
Femmina Maschio
Fig.246





Raccordo Acciaio Zincato
Niples Ridotto
Maschio Maschio
Fig.245

CODICE	MISURA	UM	PZ	€
001 099 024	D.1/2 x3/8	PZ	10	1,30
001 099 025	D.3/4 x1/2	PZ	10	2,20
001 099 067	D.1" x1/2	PZ	10	4,10
001 099 068	D.1" x3/4	PZ	10	4,10
001 099 042	D.1"1/4x1"	PZ	10	6,70



Raccordo Acciaio Zincato
Niples Doppio
Maschio Maschio
Fig.280

CODICE	MISURA	UM	PZ	€
001 099 038	D.3/8	PZ	10	1,00
001 099 037	D.1/2	PZ	10	1,30
001 099 059	D.3/4	PZ	10	1,50
001 099 060	D.1"	PZ	10	3,50
001 099 076	D.1"1/4	PZ	10	7,40



Raccordo Acciaio Zincato
Giunzione Filettato
Fig.531

CODICE	MISURA	UM	PZ	€
001 099 007	D.1/2	PZ	10	0,50



Raccordo Acciaio Zincato
Manicotto
Femmina Femmina
Fig.268/Z

CODICE	MISURA	UM	PZ	€
001 099 087	D.1/2	PZ	10	1,80
001 099 095	D.3/4	PZ	10	2,30
001 099 096	D.1"	PZ	10	3,30
001 099 097	D.1"1/4	PZ	10	3,10



Raccordo Acciaio Zincato
Manicotto Ridotto
Femmina Femmina
Fig.240

CODICE	MISURA	UM	PZ	€
001 099 033	D.1/2 x3/8	PZ	10	1,80
001 099 026	D.3/4 x1/2	PZ	10	2,30
001 099 066	D.1" x3/4	PZ	10	3,70
001 099 077	D.1" x1/2	PZ	10	4,00
001 099 072	D.1"1/4x1"	PZ	10	17,40



Raccordo Acciaio Zincato
Ghiera Esagonale
Fig.310

CODICE	MISURA	UM	PZ	€
001 099 110	D.3/8	PZ	10	1,40
001 099 117	D.1/2	PZ	10	2,10
001 099 115	D.3/4	PZ	10	3,00
001 099 111	D.1"	PZ	10	3,10



CODICE	MISURA	UM	PZ	€
001 099 043	D.1/2 x100	PZ	10	1,50
001 099 046	D.1/2 x150	PZ	10	1,90
001 099 050	D.1/2 x200	PZ	10	2,50
001 099 140	D.1/2 x250	pz	10	3,00
001 099 080	D.1/2 x300	PZ	10	3,40
001 099 052	D.1/2 x500	PZ	10	5,10
001 099 044	D.3/4 x100	PZ	10	1,70
001 099 047	D.3/4 x150	PZ	10	2,10
001 099 051	D.3/4 x200	PZ	10	2,90
001 099 141	D.3/4 x250	PZ	10	3,30
001 099 081	D.3/4 x300	PZ	10	4,00
001 099 053	D.3/4 x500	PZ	10	6,20
001 099 045	D.1" x100	PZ	10	2,30
001 099 048	D.1" x150	PZ	10	3,00
001 099 054	D.1" x200	PZ	10	4,00
001 099 142	D.1" x250	PZ	10	4,90
001 099 082	D.1" x300	PZ	10	5,90
001 099 101	D.1" x500	PZ	10	9,20
001 099 089	D.1"1/4x100	PZ	10	2,90
001 099 049	D.1"1/4x150	PZ	10	4,00
001 099 100	D.1"1/4x200	PZ	10	5,10
001 099 143	D.1"1/4x250	PZ	10	6,60
001 099 090	D.1"1/4x300	PZ	10	7,10
001 099 102	D.1"1/4x500	PZ	10	11,70
001 099 107	D.1"1/2x100	PZ	10	3,40
001 099 108	D.1"1/2x150	PZ	10	4,50
001 099 109	D.1"1/2x200	PZ	10	5,90
001 099 144	D.1"1/2x250	PZ	10	7,30
001 099 120	D.1"1/2x300	PZ	10	7,80
001 099 121	D.1"1/2x500	PZ	10	16,10
001 099 130	D.2" x100	PZ	10	4,20
001 099 131	D.2" x150	PZ	10	6,00
001 099 132	D.2" x200	PZ	10	7,90
001 099 145	D.2" x250	PZ	10	9,60
001 099 133	D.2" x300	PZ	10	11,30
001 099 134	D.2" x500	PZ	10	18,40

Raccordo Acciaio
Barilotto Filettato
Maschio Maschio
Fig.530



CODICE	MISURA	UM	PZ	€
001 099 103	D.1/2 x100	PZ	10	1,70
001 099 104	D.3/4 x120	PZ	10	2,90
001 099 105	D.1" x140	PZ	10	5,90
001 099 106	D.1"1/4x150	PZ	10	9,00

Raccordo Acciaio
Barilotto Allungabile
Filettato Maschio Maschio
Fig.532





Tubo Polietilene
Alta Densità
per Acqua

CODICE	MISURA	UM	PZ	€
001 119 034	D.20 PN16	ML	100	0,90
001 119 040	D.20 PN25	ML	100	1,30
001 119 035	D.25 PN16	ML	100	1,40
001 119 041	D.25 PN25	ML	100	1,90
001 119 036	D.32 PN16	ML	100	2,10
001 119 042	D.32 PN25	ML	100	2,90
001 119 037	D.40 PN16	ML	100	3,10
001 119 039	D.40 PN25	ML	100	4,30
001 119 047	D.50 PN16	ML	100	5,20
001 119 048	D.50 PN25	ML	100	8,10
001 119 038	D.63 PN16	ML	100	7,50
001 119 049	D.63 PN25	ML	100	10,80



Tubo Polietilene
per Gas

CODICE	MISURA	UM	PZ	€
001 119 050	D.20	ML	100	1,30
001 119 051	D.25	ML	100	1,60
001 119 052	D.32	ML	100	2,20



Raccordo Polietilene
PP Manicotto Giunzione

CODICE	MISURA	UM	PZ	€
001 148 044	D.20x20	PZ	10	3,10
001 148 008	D.25x25	PZ	10	3,60
001 148 009	D.32x32	PZ	10	4,70
001 148 034	D.40x40	PZ	10	7,60
001 148 033	D.50x50	PZ	10	10,30
001 148 010	D.63x63	PZ	10	14,30
001 148 070	D.90x90	PZ	10	33,20



Raccordo Polietilene
PP Dritto Maschio

CODICE	MISURA	UM	PZ	€
001 148 045	D.20x1/2	PZ	10	1,80
001 148 058	D.20x3/4	PZ	10	1,80
001 148 021	D.25x3/4	PZ	10	2,10
001 148 038	D.32x1"	PZ	10	2,60
001 148 046	D.40x1"1/4	PZ	10	4,80
001 148 043	D.50x1"1/2	PZ	10	6,20
001 148 022	D.63x2"	PZ	10	8,80



Raccordo Polietilene
PP Gomito Maschio

CODICE	MISURA	UM	PZ	€
001 148 013	D.20x1/2	PZ	10	2,10
001 148 066	D.20x3/4	PZ	10	2,00
001 148 014	D.25x3/4	PZ	10	2,50
001 148 015	D.32x1"	PZ	10	3,20
001 148 053	D.40x1"1/4	PZ	10	5,10
001 148 082	D.50x1"1/2	PZ	10	6,90
001 148 016	D.63x2"	PZ	10	9,60



CODICE	MISURA	UM	PZ	€
001 148 052	D.20x1/2	PZ	10	2,30
001 148 056	D.20x3/4	PZ	10	2,30
001 148 035	D.25x3/4	PZ	10	2,90
001 148 036	D.32x1"	PZ	10	3,40
001 148 017	D.40x1"1/4	PZ	10	6,60
001 148 084	D.50x1"1/2	PZ	10	8,70
001 148 018	D.63x2"	PZ	10	11,90

Raccordo Polietilene
PP Gomito Femmina



CODICE	MISURA	UM	PZ	€
001 148 055	D.20x1/2 x20	PZ	10	3,20
001 148 067	D.20x3/4 x20	PZ	10	3,20
001 148 039	D.25x3/4 x25	PZ	10	4,00
001 148 023	D.32x1" x32	PZ	10	5,20
001 148 024	D.40x1"1/4x40	PZ	10	9,60
001 148 083	D.50x1"1/2x50	PZ	10	12,70
001 148 025	D.63x2" x63	PZ	10	18,20

Raccordo Polietilene
PP Tee Femmina



CODICE	MISURA	UM	PZ	€
001 148 040	D.20x20x20	PZ	10	4,00
001 148 026	D.25x25x25	PZ	10	5,20
001 148 054	D.32x32x32	PZ	10	6,80
001 148 027	D.40x40x40	PZ	10	11,10
001 148 085	D.50x50x50	PZ	10	15,00
001 148 028	D.63x63x63	PZ	10	21,40

Raccordo Polietilene
PP Tee 3 Dadi



CODICE	MISURA	UM	PZ	€
001 148 090	D.16	PZ	10	1,70
001 148 091	D.20	PZ	10	2,10
001 148 092	D.25	PZ	10	2,30
001 148 093	D.32	PZ	10	2,80
001 148 094	D.40	PZ	10	4,70
001 148 095	D.50	PZ	10	6,90
001 148 096	D.63	PZ	10	9,30

Raccordo Polietilene
PP Tappo Terminale



CODICE	MISURA	UM	PZ	€
001 148 047	D.20x1/2	PZ	10	1,90
001 148 079	D.20x3/4	PZ	10	1,90
001 148 011	D.25x3/4	PZ	10	2,20
001 148 012	D.32x1"	PZ	10	2,80
001 148 048	D.40x1"1/4	PZ	10	4,30
001 148 080	D.50x1"1/2	PZ	10	6,20
001 148 049	D.63x2"	PZ	10	8,80

Raccordo Polietilene
PP Dritto Femmina



CODICE	MISURA	UM	PZ	€
001 148 050	D.20x20	PZ	10	3,10
001 148 019	D.25x25	PZ	10	3,70
001 148 020	D.32x32	PZ	10	4,60
001 148 037	D.40x40	PZ	10	8,00
001 148 081	D.50x50	PZ	10	11,10
001 148 051	D.63x63	PZ	10	13,50

Raccordo Polietilene
PP Gomito Doppio





Raccordo Polietilene
PP Giunto Presa

CODICE	MISURA	UM	PZ	€
001 148 060	D.20x1/2	PZ	10	3,40
001 148 030	D.25x1/2	PZ	10	5,10
001 148 032	D.32x1/2	PZ	0	5,50
001 148 041	D.32x1"	PZ	10	2,40
001 148 042	D.40x1"	PZ	10	4,00
001 148 029	D.40x3/4	PZ	10	4,00
001 148 089	D.50x3/4	PZ	10	4,70
001 148 031	D.63x1"	PZ	10	5,50



Raccordo Polietilene
PP O-Ring

CODICE	MISURA	UM	PZ	€
001 148 150	D.20	PZ	10	0,50
001 148 151	D.25	PZ	10	0,60
001 148 152	D.32	PZ	10	0,70
001 148 153	D.40	PZ	10	1,00
001 148 154	D.50	PZ	10	1,10
001 148 155	D.63	PZ	10	1,60



Raccordo Polietilene
PP Gomito con Staffa Murale

CODICE	MISURA	UM	PZ	€
001 148 145	D.20x1/2	PZ	10	5,80
001 148 146	D.25x3/4	PZ	10	6,90



Raccordo Polietilene
PP Manicotto Giunzione
Ridotto

CODICE	MISURA	UM	PZ	€
001 148 130	D.25x20	PZ	10	3,30
001 148 131	D.32x20	PZ	10	4,30
001 148 132	D.32x25	PZ	10	4,30
001 148 133	D.40x25	PZ	10	7,40
001 148 134	D.40x32	PZ	10	7,40
001 148 135	D.50x25	PZ	10	9,60
001 148 136	D.50x32	PZ	10	9,60
001 148 137	D.50x40	PZ	10	9,60
001 148 138	D.63x25	PZ	10	13,50
001 148 139	D.63x32	PZ	10	13,50
001 148 140	D.63x40	PZ	10	13,50
001 148 141	D.63x50	PZ	10	13,50



Raccordo Polietilene
PP a Saldare Manicotto
Giunzione

CODICE	MISURA	UM	PZ	€
001 148 100	D.25	PZ	10	8,20
001 148 101	D.32	PZ	10	8,40



CODICE	MISURA	UM	PZ	€
001 148 105	D.25	PZ	10	20,40
001 148 106	D.32	PZ	10	20,40

Raccordo Polietilene
PP a Saldare Gomito



CODICE	MISURA	UM	PZ	€
001 148 110	D.3/4x25	PZ	10	30,70
001 148 111	D.1" x32	PZ	10	33,90

Giunto di Transazione
Polietilene a Saldare Ottone
Maschio



CODICE	MISURA	UM	PZ	€
001 148 115	D.3/4x25	PZ	10	42,60
001 148 116	D.1" x32	PZ	10	47,00

Giunto di Transazione
Polietilene a Saldare Ottone
Femmina



CODICE	MISURA	UM	PZ	€
001 148 120	D.3/4x25	PZ	10	35,10
001 148 121	D.1" x32	PZ	10	35,10

Giunto di Transazione
Polietilene a Saldare Zincato
Maschio



CODICE	MISURA	UM	PZ	€
001 148 122	D.3/4x25	PZ	10	51,10
001 148 123	D.1" x32	PZ	10	55,40

Giunto di Transazione
Polietilene a Saldare Zincato
Curvo Maschio



CODICE	MISURA	UM	PZ	€
001 015 001	D.1/2 PN10	PZ	10	30,10
001 015 002	D.3/4 PN10	PZ	10	24,80
001 015 003	D.1" PN10	PZ	10	30,40
001 015 004	D.1"1/4 PN10	PZ	10	45,30

Giunto Dielettrico Filettato
Maschio Femmina





SETTORE 001

IDRAULICA



Flessibile Trecciato
Acciaio Inox Prolungato
Maschio Femmina

CODICE	MISURA	UM	PZ	€
001 123 090	D.1/2x1/2 Cm 20	PZ	10	4,30
001 123 091	D.1/2x1/2 Cm 30	PZ	10	4,90
001 123 092	D.1/2x1/2 Cm 35	PZ	10	5,10
001 123 093	D.1/2x1/2 Cm 40	PZ	10	4,80
001 123 094	D.1/2x1/2 Cm 50	PZ	10	4,80
001 123 095	D.1/2x1/2 Cm 60	PZ	10	5,50
001 123 096	D.1/2x1/2 Cm 80	PZ	10	7,70
001 123 097	D.1/2x1/2 Cm 100	PZ	10	6,30
001 123 100	D.1/2x3/8 Cm 20	PZ	10	4,30
001 123 101	D.1/2x3/8 Cm 30	PZ	10	4,90
001 123 102	D.1/2x3/8 Cm 35	PZ	10	5,10
001 123 103	D.1/2x3/8 Cm 40	PZ	10	5,50
001 123 104	D.1/2x3/8 Cm 50	PZ	10	5,90
001 123 105	D.1/2x3/8 Cm 60	PZ	10	6,60
001 123 106	D.1/2x3/8 Cm 80	PZ	10	6,00
001 123 107	D.1/2x3/8 Cm 100	PZ	10	9,10
001 123 086	D.3/8x3/8 Cm 20	PZ	10	4,10
001 123 005	D.3/8x3/8 Cm 30	PZ	10	4,30
001 123 006	D.3/8x3/8 Cm 35	PZ	10	4,80
001 123 007	D.3/8x3/8 Cm 40	PZ	10	5,10
001 123 036	D.3/8x3/8 Cm 50	PZ	10	5,70
001 123 037	D.3/8x3/8 Cm 60	PZ	10	5,00
001 123 087	D.3/8x1/2 Cm 20	PZ	10	4,10
001 123 012	D.3/8x1/2 Cm 30	PZ	10	4,30
001 123 013	D.3/8x1/2 Cm 35	PZ	10	4,90
001 123 014	D.3/8x1/2 Cm 40	PZ	10	4,90
001 123 015	D.3/8x1/2 Cm 50	PZ	10	5,70
001 123 049	D.3/8x1/2 Cm 60	PZ	10	6,30



Flessibile Trecciato
Acciaio Inox
Femmina Femmina

CODICE	MISURA	UM	PZ	€
001 123 058	D.3/8x3/8 Cm 20	PZ	10	3,50
001 123 081	D.3/8x3/8 Cm 30	PZ	10	3,70
001 123 030	D.3/8x3/8 Cm 35	PZ	10	4,00
001 123 064	D.3/8x3/8 Cm 40	PZ	10	4,20
001 123 065	D.3/8x3/8 Cm 50	PZ	10	5,30
001 123 066	D.3/8x3/8 Cm 60	PZ	10	5,90
001 123 067	D.1/2x1/2 Cm 20	PZ	10	3,70
001 123 068	D.1/2x1/2 Cm 30	PZ	10	3,70
001 123 069	D.1/2x1/2 Cm 35	PZ	10	3,50
001 123 028	D.1/2x1/2 Cm 40	PZ	10	4,20
001 123 070	D.1/2x1/2 Cm 50	PZ	10	5,50
001 123 071	D.1/2x1/2 Cm 60	PZ	10	6,10
001 123 072	D.3/8x1/2 Cm 20	PZ	10	3,50
001 123 073	D.3/8x1/2 Cm 30	PZ	10	3,70
001 123 074	D.3/8x1/2 Cm 35	PZ	10	3,50
001 123 029	D.3/8x1/2 Cm 40	PZ	10	4,20
001 123 075	D.3/8x1/2 Cm 50	PZ	10	5,30
001 123 076	D.3/8x1/2 Cm 60	PZ	10	5,90



CODICE	MISURA	UM	PZ	€
001 123 115	D. 3/4x3/4 Cm 30	PZ	10	10,20
001 123 116	D. 1" x1" Cm 30	PZ	10	15,90
001 123 031	D.3/4x3/4 Cm 40	PZ	10	11,10
001 123 033	D. 1" x1" Cm 40	PZ	10	17,40
001 123 088	D.3/4x3/4 Cm 50	PZ	10	15,30
001 123 032	D.3/4x3/4 Cm 60	PZ	10	13,10
001 123 035	D. 1" x1" Cm 50	PZ	10	19,10
001 123 034	D. 1" x1" Cm 60	PZ	10	21,20

Flessibile Trecciato
Antivibrante
Maschio Femmina



CODICE	MISURA	UM	PZ	€
001 123 038	D.10x3/8 Cm 30	PZ	10	5,50
001 123 039	D.10x3/8 Cm 50	PZ	10	6,70
001 123 040	D.10x1/2 Cm 30	PZ	10	5,90
001 123 041	D.10x1/2 Cm 50	PZ	10	6,90

Flessibile Trecciato
Acciaio Inox
Maschio Femmina
per Cannette



CODICE	MISURA	UM	PZ	€
001 123 077	D.10x3/8 Cm 30	PZ	10	5,50
001 123 078	D.10x3/8 Cm 50	PZ	10	6,70
001 123 079	D.10x1/2 cm 30	PZ	10	5,30
001 123 083	D.10x1/2 cm 50	PZ	10	6,30

Flessibile Treccia
Acciaio Inox
Maschio Maschio
per Cannette



CODICE	MISURA	UM	PZ	€
001 123 042	D.1/2x3/8 Cm 35	PZ	10	3,80
001 123 043	D.1/2x1/4 Cm 35	PZ	10	3,20
001 123 085	D.3/8x1/4 Cm 35	PZ	10	3,30
001 123 089	D.3/8x1/8 Cm 35	PZ	10	3,90

Flessibile Trecciato
Acciaio Inox
Femmina Maschio
per Miscelatori



CODICE	MISURA	UM	PZ	€
011 055 022	D.3/8 Grohe	PZ	10	16,90

Flessibile Trecciato
Acciaio Inox
Femmina Maschio
per Miscelatori Grohe



CODICE	MISURA	UM	PZ	€
001 123 120	D.10x1/2 Cm 35	PZ	10	3,60

Flessibile Trecciato
Acciaio Inox
Maschio Femmina
Prolungato





Raccordo Rapido Estensibile
Jollyflex con Ghiera
Metallica - Bonomini

CODICE	MISURA	UM	PZ	€
001 132 001	D.1" x32	PZ	10	3,90
001 132 002	D.1"1/4x32	PZ	10	2,60
001 132 003	D.1"1/2x40	PZ	10	2,60



Raccordo Rapido Estensibile
StarFless con Ghiera
Metallica - Idro

CODICE	MISURA	UM	PZ	€
001 132 020	D.1" x26	PZ	10	1,90
001 132 021	D.1" x32	PZ	10	1,90
001 132 022	D.1" 1/4 x32	PZ	10	1,90
001 132 023	D.1" 1/2 x32	PZ	10	1,90



Raccordo Rapido
Estensibile **Jollyflex**
Con Ghiera Metallica Cromo

CODICE	MISURA	UM	PZ	€
001 132 005	D.1" x32	PZ	10	10,20
001 132 006	D.1"1/4x32	PZ	10	9,30
001 132 007	D.1"1/2x40	PZ	10	9,50



Raccordo Rapido Estensibile
Jollyflex Doppio Tubo

CODICE	MISURA	UM	PZ	€
001 132 004	D.1"1/2x40/50	PZ	10	4,70



Sifone Flessibile per Lavabo
e Bidet Cromo/bianco

CODICE	MISURA	UM	PZ	€
001 132 029	D.1" x32x300	PZ	10	13,20
001 132 030	D.1"1/4x32x300	PZ	10	14,50



Raccordo Rapido Estensibile
Jollyflex Curvo Bonomini

CODICE	MISURA	UM	PZ	€
001 132 008	D.1"1/4x32x300	PZ	10	6,70
001 132 009	D.1"1/2x32x300	PZ	10	6,60



Tubo di Carico Lavatrice
Attacco 90° Curvo

CODICE	MISURA	UM	PZ	€
001 133 034	D.3/4 x Cm 150	PZ	10	3,60
001 133 037	D.3/4 x Cm 200	PZ	10	5,00



Tubo di Carico Lavatrice
Attacco Diritto

CODICE	MISURA	UM	PZ	€
001 133 040	D.3/4 x Cm 150	PZ	10	3,60
001 133 041	D.3/4 x Cm 200	PZ	10	4,10



Tubo di Scarico Lavatrice

CODICE	MISURA	UM	PZ	€
001 133 035	Cm 150	PZ	10	1,30
001 133 036	Cm 200	PZ	10	2,70



Tubo di Scarico Lavatrice
Estensibile

CODICE	MISURA	UM	PZ	€
001 133 038	Cm 150 - Cm 200	PZ	10	3,80



CODICE	MISURA	UM	PZ	€
001 155 001		PZ	10	97,50

Batteria Scarico Wc Catis
Brevettata con Pulsante



CODICE	MISURA	UM	PZ	€
001 155 008		PZ	10	63,10

Batteria Scarico Wc Catis
Brevettata Senza Pulsante



CODICE	MISURA	UM	PZ	€
001 155 012		PZ	10	122,40

Batteria Scarico Wc Catis
Brevettata Maggiorata con Pulsante



CODICE	MISURA	UM	PZ	€
001 155 002		PZ	10	101,30

Batteria Scarico Wc Catis
New Junior per Cassette
Mezza Altezza



CODICE	MISURA	UM	PZ	€
001 155 011		PZ	10	47,40

Pulsante con Tubo Rame
per Scarico Wc Catis



CODICE	MISURA	UM	PZ	€
001 155 009		PZ	10	6,90

Molla Pulsante per Scarico
Wc Catis



CODICE	MISURA	UM	PZ	€
001 155 020		PZ	10	25,00

Kit Guarnizioni
Batteria Catis



CODICE	MISURA	UM	PZ	€
001 155 010		PZ	10	1,20

Guarnizione Sifone per
Scarico Wc Catis Senza
Nottolino



CODICE	MISURA	UM	PZ	€
003 006 037		PZ	10	1,60

Guarnizione Sifone per
Scarico Wc Catis
Con Nottolino



CODICE	MISURA	UM	PZ	€
001 155 005		PZ	1	70,00

Batteria Scarico Wc
Monoblocco Catis New





Batteria Fait Its Todini
Scarico Wc

CODICE	MISURA	UM	PZ	€
001 156 001	Its 8,00	PZ	10	78,50



Batteria Curva con Pulsante
Senza Tubo & Borchia
Its Todini

CODICE	MISURA	UM	PZ	€
001 156 002	Its 6,00	PZ	10	117,90



Batteria Curva Solo Sifone
Its Todini Scarico Wc

CODICE	MISURA	UM	PZ	€
001 156 009	Its 6,02	PZ	10	65,10



Galleggiante FluidMaster
Its Todini Laterale

CODICE	MISURA	UM	PZ	€
001 156 010	Its 3,01	PZ	10	27,60



Cappello di Sollevamento
per Curva 6.00 e 6.02 ITS

CODICE	MISURA	UM	PZ	€
001 156 007	Wc 6.00 e 6.02 ITS	PZ	10	1,10



Guarnizione di Fondo per
Curva WC 6.00 e 6.02 ITS

CODICE	MISURA	UM	PZ	€
001 156 011	Wc 6.00 e 6.02 ITS	PZ	10	1,20



Membrana di Chiusura per
Batteria Fait 8.19 Its

CODICE	MISURA	UM	PZ	€
001 156 006	8.19 its	PZ	10	2,10



Batteria Scarico Wc DI.BA.
Con Pulsante

CODICE	MISURA	UM	PZ	€
001 155 100		PZ	10	94,30



Batteria Scarico Wc DI.BA.
Senza Pulsante

CODICE	MISURA	UM	PZ	€
001 155 101		PZ	10	66,30

CODICE	MISURA	UM	PZ	€
001 165 001	D.20x1/2	PZ	10	4,00
001 165 002	D.25x3/4	PZ	10	5,30
001 165 003	D.32x1"	PZ	10	8,80
001 165 004	D.40x1"1/4	PZ	10	12,40
001 165 061	D.50x1"1/2	PZ	10	18,90
001 165 005	D.63x2"	PZ	10	40,40

Raccordo a Compressione in Ottone Diritto Maschio



CODICE	MISURA	UM	PZ	€
001 165 006	D.20x1/2	PZ	10	3,70
001 165 007	D.25x3/4	PZ	10	5,60
001 165 008	D.32x1"	PZ	10	9,10
001 165 009	D.40x1"1/4	PZ	10	13,70
001 165 062	D.50x1"1/2	PZ	10	19,60
001 165 010	D.63x2"	PZ	10	42,00

Raccordo a Compressione in Ottone Diritto Femmina



CODICE	MISURA	UM	PZ	€
001 165 011	D.20x20	PZ	10	6,90
001 165 012	D.25x25	PZ	10	9,10
001 165 013	D.32x32	PZ	10	14,20
001 165 014	D.40x40	PZ	10	20,50
001 165 063	D.50x50	PZ	10	30,90
001 165 015	D.63x63	PZ	10	69,60

Raccordo a Compressione in Ottone Diritto Doppio



CODICE	MISURA	UM	PZ	€
001 165 016	D.20x20x20	PZ	10	10,40
001 165 017	D.25x25x25	PZ	10	12,60
001 165 018	D.32x32x32	PZ	10	21,50
001 165 019	D.40x40x40	PZ	10	30,20
001 165 064	D.50x50x50	PZ	10	56,10
001 165 020	D.63x63x63	PZ	10	76,20

Raccordo a Compressione in Ottone Tee 3 Dadi



CODICE	MISURA	UM	PZ	€
001 165 021	D.20x1/2 x20	PZ	10	7,90
001 165 022	D.25x3/4 x25	PZ	10	11,40
001 165 023	D.32x1" x32	PZ	10	18,20
001 165 024	D.40x1"1/4x40	PZ	10	22,40
001 165 065	D.50x1"1/2x50	PZ	10	48,00
001 165 025	D.63x2" x63	PZ	10	55,10

Raccordo a Compressione in Ottone Tee Femmina



CODICE	MISURA	UM	PZ	€
001 165 026	D.20x1/2	PZ	10	5,10
001 165 027	D.25x3/4	PZ	10	7,00
001 165 028	D.32x1"	PZ	10	11,60
001 165 029	D.40x1"1/4	PZ	10	20,00
001 165 066	D.50x1"1/2	PZ	10	28,50
001 165 030	D.63x2"	PZ	10	61,20

Raccordo a Compressione in Ottone Gomito Maschio





Raccordo a Compressione in Ottone Gomito Femmina

CODICE	MISURA	UM	PZ	€
001 165 031	D.20x1/2	PZ	10	5,10
001 165 032	D.25x3/4	PZ	10	7,00
001 165 033	D.32x1"	PZ	10	11,60
001 165 034	D.40x1"1/4	PZ	10	19,10
001 165 067	D.50x1"1/2	PZ	10	30,90
001 165 035	D.63x2"	PZ	10	54,60



Raccordo a Compressione in Ottone Gomito Doppio

CODICE	MISURA	UM	PZ	€
001 165 036	D.20x20	PZ	10	7,40
001 165 040	D.25x25	PZ	10	10,40
001 165 037	D.32x32	PZ	10	16,30
001 165 038	D.40x40	PZ	10	23,90
001 165 068	D.50x50	PZ	10	39,10
001 165 039	D.63x63	PZ	10	68,10



Raccordo a Compressione in Ottone Gomito Femmina Flangiato

CODICE	MISURA	UM	PZ	€
001 165 046	D.20x1/2	PZ	10	6,90
001 165 047	D.25x3/4	PZ	10	7,70
001 165 048	D.32x1"	PZ	10	13,10



Raccordo Bussolotto in Ottone Manicotto di Sostegno

CODICE	MISURA	UM	PZ	€
001 165 049	D.20x1/2	PZ	10	1,20
001 165 050	D.25x3/4	PZ	10	1,30
001 165 051	D.32x1"	PZ	10	1,30
001 165 053	D.40x1"1/4	PZ	10	2,70
001 165 069	D.50x1"1/2	PZ	10	3,80
001 165 054	D.63x2"	PZ	10	11,30



Raccordo Bussolotto in Acciaio Manicotto di Sostegno

CODICE	MISURA	UM	PZ	€
001 165 041	D.20x1/2	PZ	10	1,70
001 165 042	D.25x3/4	PZ	10	1,70
001 165 043	D.32x1"	PZ	10	2,30
001 165 044	D.40x1"1/4	PZ	10	2,50
001 165 070	D.50x1"1/2	PZ	10	3,80
001 165 045	D.63x2"	PZ	10	4,90



CODICE	MISURA	UM	PZ	€
001 170 315	D.3/8x2 Cm	PZ	10	1,50
001 170 316	D.3/8x3 Cm	PZ	10	2,20
001 170 317	D.3/8x5 Cm	PZ	10	3,00
001 170 001	D.1/2x1 Cm	PZ	10	1,60
001 170 002	D.1/2x1,5 Cm	PZ	10	2,00
001 170 003	D.1/2x2 Cm	PZ	10	2,30
001 170 088	D.1/2x3 Cm	PZ	10	3,30
001 170 226	D.1/2x4 Cm	PZ	10	4,10
001 170 004	D.1/2x5 Cm	PZ	10	4,90
001 170 199	D.3/4x1 Cm	PZ	10	2,30
001 170 151	D.3/4x1,5 Cm	PZ	10	2,80
001 170 154	D.3/4x2 Cm	PZ	10	3,40
001 170 155	D.3/4x3 Cm	PZ	10	4,30
001 170 156	D.3/4x5 Cm	PZ	10	6,30
001 170 227	D.1" x2 Cm	PZ	10	4,90
001 170 005	D.1" x3 Cm	PZ	10	6,90
001 170 228	D.1" x4 Cm	PZ	10	7,90
001 170 089	D.1" x5 Cm	PZ	10	9,70

CODICE	MISURA	UM	PZ	€
001 170 012	D.1/4 x1/8	PZ	10	1,40
001 170 013	D.3/8 x1/4	PZ	10	1,20
001 170 138	D.1/2 x1/4	PZ	10	1,40
001 170 011	D.1/2 x3/8	PZ	10	1,40
001 170 014	D.3/4 x1/2	PZ	10	2,20
001 170 010	D.1" x3/4	PZ	10	3,00
001 170 141	D.1" x1/2	PZ	10	2,90
001 170 197	D.1"1/4 x1"	PZ	10	4,70

CODICE	MISURA	UM	PZ	€
001 170 017	D.3/8 x1/4	PZ	10	2,00
001 170 201	D.1/2 x1/4	PZ	10	1,40
001 170 018	D.1/2 x3/8	PZ	10	1,40
001 170 231	D.3/4 x3/8	PZ	10	1,70
001 170 019	D.3/4 x1/2	PZ	10	2,00
001 170 020	D.1" x1/2	PZ	10	3,10
001 170 021	D.1" x3/4	PZ	10	3,50
001 170 232	D.1"1/4x1/2	PZ	10	5,30
001 170 233	D.1"1/4x3/4	PZ	10	5,30
001 170 092	D.1"1/4x1"	PZ	10	5,10
001 170 235	D.1"1/2x3/4	PZ	10	7,60
001 170 234	D.1"1/2x1"	PZ	10	7,00
001 170 172	D.1"1/2x1"1/4	PZ	10	6,10
001 170 236	D.2" x1"	PZ	10	8,70
001 170 173	D.2" x1"1/2	PZ	10	9,10
001 170 174	D.2" x1"1/4	PZ	10	12,20

CODICE	MISURA	UM	PZ	€
001 170 169	D.1/8	PZ	10	0,60
001 170 093	D.1/4	PZ	10	0,90
001 170 026	D.3/8	PZ	10	1,10
001 170 027	D.1/2	PZ	10	1,40
001 170 028	D.3/4	PZ	10	2,00
001 170 029	D.1"	PZ	10	3,20
001 170 094	D.1"1/4	PZ	10	5,60
001 170 170	D.1"1/2	PZ	10	5,70
001 170 171	D.2"	PZ	10	8,30

Raccordo Ottone Giallo
Prolunga Maschio Femmina



Raccordo Ottone Giallo
Prolunga Ridotta Femmina
Maschio



Raccordo Ottone Giallo Niples
Ridotto Maschio Maschio



Raccordo Ottone Giallo Niples
Maschio Maschio





SETTORE 001

IDRAULICA



Raccordo Ottone Giallo
Riduzione
Maschio Femmina

CODICE	MISURA	UM	PZ	€
001 170 096	D.1/4 x1/8	PZ	10	0,80
001 170 034	D.3/8 x1/4	PZ	10	1,00
001 170 202	D.1/2 x1/4	PZ	10	1,40
001 170 035	D.1/2 x3/8	PZ	10	1,00
001 170 196	D.3/4 x3/8	PZ	10	2,20
001 170 036	D.3/4 x1/2	PZ	10	1,30
001 170 148	D.1" x3/8	PZ	10	3,10
001 170 037	D.1" x1/2	PZ	10	3,30
001 170 040	D.1" x3/4	PZ	10	2,50
001 170 175	D.1"1/4x1/2	PZ	10	6,30
001 170 176	D.1"1/4x3/4	PZ	10	5,60
001 170 177	D.1"1/4x1"	PZ	10	4,30
001 170 239	D.1"1/2x3/4	PZ	10	8,10
001 170 238	D.1"1/2x1"	PZ	10	6,60
001 170 178	D.1"1/2x1"1/4	PZ	10	4,70
001 170 181	D.2" x1"	PZ	10	9,30
001 170 180	D.2" x1"1/4	PZ	10	8,20
001 170 179	D.2" x1"1/2	PZ	10	10,50
001 170 240	D.2" x3/4	PZ	10	13,90



Raccordo Ottone Giallo
Tappo Femmina Ridotto

CODICE	MISURA	UM	PZ	€
001 041 196	D.3/8x3/4	PZ	10	3,50
001 041 197	D.3/8x1"	PZ	10	3,90



Raccordo Ottone Giallo
Tappo Femmina

CODICE	MISURA	UM	PZ	€
001 170 042	D.1/8	PZ	10	0,50
001 170 043	D.1/4	PZ	10	0,80
001 170 044	D.3/8	PZ	10	0,90
001 170 045	D.1/2	PZ	10	1,00
001 170 046	D.3/4	PZ	10	1,50
001 170 047	D.1"	PZ	10	2,20
001 170 048	D.1"1/4	PZ	10	3,50
001 170 241	D.1"1/2	PZ	10	4,80
001 170 242	D.2"	PZ	10	9,60



Raccordo Ottone Giallo
Tappo Maschio

CODICE	MISURA	UM	PZ	€
001 170 053	D.1/8	PZ	10	0,60
001 170 054	D.1/4	PZ	10	0,70
001 170 055	D.3/8	PZ	10	1,00
001 170 056	D.1/2	PZ	10	1,00
001 170 057	D.3/4	PZ	10	1,60
001 170 058	D.1"	PZ	10	2,70
001 170 097	D.1"1/4	PZ	10	4,30
001 170 182	D.1"1/2	PZ	10	6,90
001 170 183	D.2"	PZ	10	6,10



Raccordo Ottone Giallo
ad Y Femmina

CODICE	MISURA	UM	PZ	€
001 170 139	D.3/4	PZ	10	6,00

CODICE	MISURA	UM	PZ	€
001 170 224	D.1/4	PZ	10	1,10
001 170 062	D.3/8	PZ	10	1,50
001 170 130	D.1/2	PZ	10	1,90
001 170 063	D.3/4	PZ	10	2,40
001 170 064	D.1"	PZ	10	4,80
001 170 099	D.1"1/4	PZ	10	5,80
001 170 184	D.1"1/2	PZ	10	9,80
001 170 185	D.2"	PZ	10	15,00

Raccordo Ottone Giallo
Manicotto
Femmina Femmina



CODICE	MISURA	UM	PZ	€
001 170 120	D.3/8x1/4	PZ	10	0,50
001 170 121	D.1/2x3/8	PZ	10	0,70
001 170 122	D.3/4x1/2	PZ	10	0,80
001 170 123	D.1" x3/4	PZ	10	1,10

Raccordo Ottone Giallo
Ghiera Ridotta
Maschio Femmina



CODICE	MISURA	UM	PZ	€
001 170 300	D.1/2	PZ	10	0,70
001 170 301	D.3/4	PZ	10	0,80
001 170 302	D.1"	PZ	10	1,60

Raccordo Ottone Giallo
Ghiera Controdado



CODICE	MISURA	UM	PZ	€
001 170 305	D.3/8	PZ	10	1,20
001 170 306	D.1/2	PZ	10	1,50
001 170 307	D.3/4	PZ	10	1,50
001 170 309	D.1"	PZ	10	2,30
001 170 303	D.1"1/4	PZ	10	3,20
001 170 304	D.1"1/2	PZ	10	4,40

Raccordo Ottone Giallo
Ghiera Controdado Flangiato



CODICE	MISURA	UM	PZ	€
001 170 067	D.1/2x3/8	PZ	10	2,00
001 170 068	D.3/4x1/2	PZ	10	2,80
001 170 069	D.1" x1/2	PZ	10	3,30
001 170 070	D.1"x3/4	PZ	10	3,40
001 170 244	D.1"1/4x3/4	PZ	10	8,10
001 170 153	D.1"1/4x1"	PZ	10	6,50
001 170 245	D.1"1/2x3/4	PZ	10	7,10
001 170 246	D.1"1/2x1"	PZ	10	12,20
001 170 186	D.1"1/2x1"1/4	PZ	10	9,50
001 170 247	D.2"x1"1/2	PZ	10	16,30
001 170 187	D.2"x1"1/4	PZ	10	16,80
001 170 188	D.2"X1"	PZ	10	14,20

Raccordo Ottone Giallo
Manicotto Ridotto
Femmina Femmina



CODICE	MISURA	UM	PZ	€
001 041 201	D.1/2	PZ	10	4,90
001 041 200	D.3/4	PZ	10	7,70
001 041 199	D.1"	PZ	10	11,20

Raccordo Ottone Giallo
Bochettone 3 Pz
Maschio Maschio



CODICE	MISURA	UM	PZ	€
001 041 220	D.1/2	PZ	10	7,30
001 041 221	D.3/4	PZ	10	11,50
001 041 222	D.1"	PZ	10	13,80
001 041 223	D.1"1/4	PZ	10	27,30
001 041 224	D.1"1/2	PZ	10	24,70
001 041 225	D.2"	PZ	10	36,20

Raccordo Ottone Giallo
Bochettone 3 Pz
Femmina Femmina

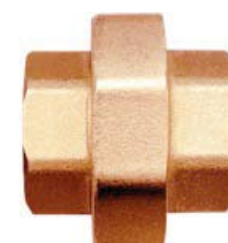



SETTORE 001

IDRAULICA



Raccordo Ottone Giallo
Bochetto 3 Pz
Maschio Femmina

CODICE	MISURA	UM	PZ	€
001 041 206	D.1/2	PZ	10	4,80
001 041 207	D.3/4	PZ	10	6,80
001 041 208	D.1"	PZ	10	11,50
001 041 209	D.1"1/4	PZ	10	15,10
001 041 210	D.1"1/2	PZ	10	28,70
001 041 211	D.2"	PZ	10	52,40



Raccordo Ottone Giallo
Gomito Ridotto
Femmina Femmina

CODICE	MISURA	UM	PZ	€
001 170 220	D.3/4x1/2	PZ	10	4,40
001 170 218	D.1" x3/4	PZ	10	7,00



Raccordo Ottone Giallo
Gomito Ridotto
Femmina Femmina

CODICE	MISURA	UM	PZ	€
001 170 221	D.3/4x1/2	PZ	10	6,90
001 170 217	D.1" x3/4	PZ	10	7,20



Raccordo Ottone Giallo
Tee Femmina Femmina

CODICE	MISURA	UM	PZ	€
001 170 157	D.1/4	PZ	10	3,30
001 170 158	D.3/8	PZ	10	3,40
001 170 072	D.1/2	PZ	10	3,20
001 170 073	D.3/4	PZ	10	4,20
001 170 074	D.1"	PZ	10	8,30
001 170 152	D.1"1/4	PZ	10	15,10
001 170 189	D.1"1/2	PZ	10	22,40
001 170 190	D.2"	PZ	10	29,20



Raccordo Ottone Giallo
Gomito Femmina Femmina

CODICE	MISURA	UM	PZ	€
001 170 326	D.1/8	PZ	10	2,40
001 170 327	D.1/4	PZ	10	3,50
001 170 078	D.3/8	PZ	10	2,80
001 170 075	D.1/2	PZ	10	3,10
001 170 076	D.3/4	PZ	10	4,00
001 170 077	D.1"	PZ	10	7,60
001 170 149	D.1"1/4	PZ	10	12,30
001 170 191	D.1"1/2	PZ	10	17,90
001 170 192	D.2"	PZ	10	29,20



Raccordo Ottone Giallo
Gomito Maschio Femmina

CODICE	MISURA	UM	PZ	€
001 170 195	D.1/8	PZ	10	2,30
001 170 142	D.1/4	PZ	10	2,50
001 170 083	D.3/8	PZ	10	2,90
001 170 080	D.1/2	PZ	10	2,50
001 170 081	D.3/4	PZ	10	4,40
001 170 082	D.1"	PZ	10	7,00
001 170 150	D.1"1/4	PZ	10	11,80
001 170 193	D.1"1/2	PZ	10	17,00
001 170 194	D.2"	PZ	10	26,90



CODICE	MISURA	UM	PZ	€
001 170 087	D.3/8	PZ	10	1,90
001 170 085	D.1/2	PZ	10	3,20
001 170 086	D.3/4	PZ	10	4,70
001 170 110	D.1"	PZ	10	6,60

Raccordo Ottone Giallo
Gomito Maschio Maschio



CODICE	MISURA	UM	PZ	€
001 170 260	D.1/2x10	PZ	10	5,60
001 170 261	D.1/2x15	PZ	10	7,40
001 170 262	D.1/2x20	PZ	10	8,70
001 170 263	D.3/4x10	PZ	10	6,00
001 170 264	D.3/4x15	PZ	10	8,80
001 170 265	D.3/4x20	PZ	10	10,50
001 170 266	D.1" x10	PZ	10	9,20
001 170 267	D.1" x15	PZ	10	13,10
001 170 268	D.1" x20	PZ	10	17,20

Raccordo Ottone Giallo
Barilotto Allungabile
Filettato



CODICE	MISURA	UM	PZ	€
001 170 160	D.1/2x10	PZ	10	4,60
001 170 161	D.1/2x15	PZ	10	7,00
001 170 162	D.1/2x20	PZ	10	8,80
001 170 250	D.1/2x25	PZ	10	11,20
001 170 163	D.3/4x10	PZ	10	5,50
001 170 164	D.3/4x15	PZ	10	8,30
001 170 165	D.3/4x20	PZ	10	10,70
001 170 251	D.3/4x25	PZ	10	13,20
001 170 252	D.3/4x30	PZ	10	13,00
001 170 166	D.1" x10	PZ	10	7,70
001 170 167	D.1" x15	PZ	10	12,10
001 170 168	D.1" x20	PZ	10	15,80
001 170 253	D.1" x25	PZ	10	18,70
001 170 254	D.1" x30	PZ	10	23,80

Raccordo Ottone Giallo
Barilotto Filettato



CODICE	MISURA	UM	PZ	€
001 170 225	D.3/8x3/8	PZ	10	8,10
001 170 204	D.1/2x1/2	PZ	10	9,80
001 170 205	D.3/4x3/4	PZ	10	13,00
001 170 206	D.1" x1"	PZ	10	16,60

Raccordo di Riparazione
Maschio per Tubo Zincato



CODICE	MISURA	UM	PZ	€
001 170 229	D.3/8x3/8	PZ	10	8,10
001 170 207	D.1/2x1/2	PZ	10	9,80
001 170 208	D.3/4x3/4	PZ	10	12,10
001 170 209	D.1" x1"	PZ	10	16,60

Raccordo di Riparazione
Femmina per Tubo Zincato



CODICE	MISURA	UM	PZ	€
001 170 215	D.3/8x3/8	PZ	10	13,20
001 170 212	D.1/2x1/2	PZ	10	14,90
001 170 213	D.3/4x3/4	PZ	10	17,90
001 170 214	D.1" x1"	PZ	10	21,20

Raccordo di Riparazione
Doppio per Tubo Zincato



CODICE	MISURA	UM	PZ	€
001 170 280	D.1/2	PZ	10	4,80
001 170 281	D.3/4	PZ	10	6,00
001 170 282	D.1"	PZ	10	8,40
001 170 283	D.1"1/4	PZ	10	10,50

Raccordo Ottone Giallo
per Serbatoio Cassone





Raccordo Ottone Giallo
Portagomma Femmina
per Tubo Gpl

CODICE	MISURA	UM	PZ	€
001 170 131	D.1/4x10	PZ	10	1,10
001 170 133	D.3/8x10	PZ	10	2,40
001 170 135	D.1/2x10	PZ	10	2,90



Raccordo Ottone Giallo
Portagomma Femmina
per Tubo Metano

CODICE	MISURA	UM	PZ	€
001 170 132	D.1/4x14	PZ	10	1,10
001 170 134	D.3/8x14	PZ	10	2,80
001 170 136	D.1/2x14	PZ	10	3,30



Raccordo Ottone Giallo
Portagomma Maschio
per Tubo Gpl

CODICE	MISURA	UM	PZ	€
001 170 114	D.1/4x10	PZ	10	0,80
001 170 116	D.3/8x10	PZ	10	2,40
001 170 118	D.1/2x10	PZ	10	2,90



Raccordo Ottone Giallo
Portagomma Maschio
per Tubo Metano

CODICE	MISURA	UM	PZ	€
001 170 115	D.1/4x14	PZ	10	0,80
001 170 117	D.3/8x14	PZ	10	2,80
001 170 119	D.1/2x14	PZ	10	3,50



Raccordo Ottone Giallo
Portagomma Gomito
Femmina per Tubo Gpl

CODICE	MISURA	UM	PZ	€
001 170 248	D.1/2x10 Gpl	PZ	10	2,90
001 170 249	D.1/2x14 Metano	PZ	10	2,80



Raccordo Ottone Giallo
Portagomma Gomito
Maschio per Tubo Gpl

CODICE	MISURA	UM	PZ	€
001 170 257	D.1/2x10 Gpl	PZ	10	3,60
001 170 258	D.1/2x14 Metano	PZ	10	3,50



Raccordo Ottone Giallo
Croce Femmina Femmina

CODICE	MISURA	UM	PZ	€
001 170 290	D.1/2	PZ	10	5,10
001 170 291	D.3/4	PZ	10	8,10
001 170 292	D.1"	PZ	10	13,00
001 170 293	D.1"1/4	PZ	10	19,10
001 170 294	D.1"1/2	PZ	10	22,10



Raccordo Ottone Giallo
Filtro a Y

CODICE	MISURA	UM	PZ	€
006 165 080	D.1/2	PZ	10	6,50
006 165 081	D.3/4	PZ	10	10,70
006 165 082	D.1"	PZ	10	16,70
006 165 083	D.1"1/4	PZ	10	25,80
006 165 084	D.1"1/2	PZ	10	34,40
006 165 085	D.2"	PZ	10	57,20



CODICE	MISURA	UM	PZ	€
001 170 320	D.3/8x1	PZ	10	1,60
001 170 321	D.3/8x2	PZ	10	2,40
001 170 322	D.3/8x3	PZ	10	2,20
001 170 323	D.3/8x5	PZ	10	4,20
001 170 006	D.1/2x1	PZ	10	1,90
001 170 007	D.1/2x1,5	PZ	10	2,20
001 170 008	D.1/2x2	PZ	10	2,60
001 170 090	D.1/2x3	PZ	10	3,50
001 170 009	D.1/2x5	PZ	10	5,40

Raccordo Ottone Cromato
Prolunga Maschio Femmina

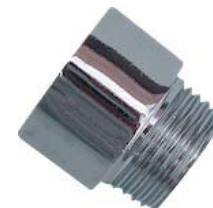

CODICE	MISURA	UM	PZ	€
001 170 137	D.3/8x1/4	PZ	10	1,20
001 170 015	D.1/2x3/8	PZ	10	2,00
001 170 016	D.3/4x1/2	PZ	10	2,90
001 170 091	D.1" x3/4	PZ	10	3,50
001 170 143	D.1" x1/2	PZ	10	3,10
001 170 200	D.1"1/4x1	PZ	10	5,20

Raccordo Ottone Cromato
Prolunga Ridotta
Femmina Maschio



CODICE	MISURA	UM	PZ	€
001 170 126	D.3/8x1/4	PZ	10	0,90
001 170 022	D.1/2x3/8	PZ	10	1,50
001 170 023	D.3/4x1/2	PZ	10	2,20
001 170 024	D.1" x1/2	PZ	10	3,80
001 170 025	D.1" x3/4	PZ	10	3,80

Raccordo Ottone Cromato
Niples Ridotta
Maschio Maschio



CODICE	MISURA	UM	PZ	€
001 170 127	D.1/4	PZ	10	0,90
001 170 030	D.3/8	PZ	10	1,30
001 170 031	D.1/2	PZ	10	1,40
001 170 032	D.3/4	PZ	10	2,10
001 170 095	D.1"	PZ	10	3,30

Raccordo Ottone Cromato
Niples Doppio
Maschio Maschio



CODICE	MISURA	UM	PZ	€
001 170 128	D.3/8x1/4	PZ	10	0,70
001 170 038	D.1/2x3/8	PZ	10	1,20
001 170 039	D.3/4x1/2	PZ	10	1,40
001 170 129	D.1" x1/2	PZ	10	2,00
001 170 041	D.1" x3/4	PZ	10	2,70

Raccordo Ottone Cromato
Riduzione
Maschio Femmina



CODICE	MISURA	UM	PZ	€
001 170 049	D.3/8	PZ	10	0,60
001 170 050	D.1/2	PZ	10	1,10
001 170 051	D.3/4	PZ	10	1,80
001 170 052	D.1"	PZ	10	1,80

Raccordo Ottone Cromato
Tappo Femmina



CODICE	MISURA	UM	PZ	€
001 170 124	D.1/2 Cromata - FFM	PZ	10	6,80
001 170 125	D.3/4 Nichelata * - MMF	PZ	10	6,80

Raccordo Ottone Cromato
a Y Maschio





SETTORE 001

IDRAULICA



Raccordo Ottone Cromato
Tappo Maschio

CODICE	MISURA	UM	PZ	€
001 170 059	D.3/8	PZ	10	1,10
001 170 060	D.1/2	PZ	10	1,20
001 170 061	D.3/4	PZ	10	1,80
001 170 098	D.1"	PZ	10	3,20



Raccordo Ottone Cromato
Manicotto
Femmina Femmina

CODICE	MISURA	UM	PZ	€
001 170 065	D.3/8	PZ	10	1,70
001 170 100	D.1/2	PZ	10	2,10
001 170 066	D.3/4	PZ	10	2,00
001 170 144	D.1"	PZ	10	3,40



Raccordo Ottone Cromato
Manicotto Ridotto
Femmina Femmina

CODICE	MISURA	UM	PZ	€
001 170 071	D.1/2 x3/8	PZ	10	2,50
001 170 101	D.3/4 x1/2	PZ	10	2,90
001 170 102	D.1" x3/4	PZ	10	4,00
001 170 145	D.1" x1/2	PZ	10	3,90
001 170 198	D.1"1/4x3/4	PZ	10	4,80



Raccordo Ottone Cromato
Tee
Femmina Femmina

CODICE	MISURA	UM	PZ	€
001 170 310	D.1/4	PZ	10	4,00
001 170 311	D.3/8	PZ	10	3,90
001 170 103	D.1/2	PZ	10	3,80
001 170 104	D.3/4	PZ	10	4,90
001 170 105	D.1"	PZ	10	8,30



Raccordo Ottone Cromato
Gomito
Femmina Femmina

CODICE	MISURA	UM	PZ	€
001 170 140	D.3/8	PZ	10	3,30
001 170 079	D.1/2	PZ	10	3,80
001 170 106	D.3/4	PZ	10	4,50
001 170 107	D.1"	PZ	10	6,80



Raccordo Ottone Cromato
Gomito
Maschio Femmina

CODICE	MISURA	UM	PZ	€
001 170 146	D.3/8	PZ	10	3,30
001 170 084	D.1/2	PZ	10	3,30
001 170 108	D.3/4	PZ	10	4,30
001 170 109	D.1"	PZ	10	6,40



Raccordo Ottone Cromato
Gomito
Maschio Maschio

CODICE	MISURA	UM	PZ	€
001 170 147	D.3/8	PZ	10	2,90
001 170 111	D.1/2	PZ	10	3,70
001 170 112	D.3/4	PZ	10	3,50
001 170 113	D.1"	PZ	10	5,30

CODICE	MISURA	UM	PZ	€
001 174 079	D. 500	PZ	10	18,30
001 174 080	D.1000	PZ	10	21,80
001 174 081	D.1500	PZ	10	24,20
001 174 082	D.2000	PZ	10	27,30
001 174 083	D.3000	PZ	10	55,20
001 174 084	D.4000	PZ	10	65,70

Flex Gas Rivestito
Norma Europea En 14800



CODICE	MISURA	UM	PZ	€
019 001 063	D.1/2x14 Cm 50	PZ	10	7,40
019 001 064	D.1/2x14 Cm 70	PZ	10	8,60
019 001 065	D.1/2x14 Cm 100	PZ	10	10,60

Flex Gas Gpl con Manichetta
Attacco Bombola



CODICE	MISURA	UM	PZ	€
001 174 020	D.1/2x1/2 MF 100-200	PZ	12	11,80
001 174 023	D.1/2x1/2 MF 210-410	PZ	12	12,60
001 174 021	D.1/2x3/4 MF 100-200	PZ	12	15,90
001 174 029	D.1/2x3/4 MF 210-410	PZ	12	20,40
001 174 022	D.3/4x3/4 MF 100-200	PZ	12	16,50
001 174 024	D.3/4x3/4 MF 210-410	PZ	12	19,90

Flex Gas Rivestito Estensibile
Maschio Femmina



CODICE	MISURA	UM	PZ	€
001 174 034	D.1/2x1/2 FF 100-200	PZ	12	14,00
001 174 035	D.1/2x1/2 FF 210-410	PZ	12	12,20
001 174 037	D.1/2x3/4 FF 100-200	PZ	12	16,90
001 174 038	D.1/2x3/4 FF 210-410	PZ	12	19,20
001 174 040	D.3/4x3/4 FF 100-210	PZ	12	19,40
001 174 041	D.3/4x3/4 FF 210-410	PZ	12	22,90

Flex Gas Rivestito Estensibile
Femmina Femmina



CODICE	MISURA	UM	PZ	€
001 174 009	D.3/4x1" Cm 16	PZ	10	13,50

Flex Gas Contatore
Estensibile



CODICE	MISURA	UM	PZ	€
001 174 055	D.1"	PZ	10	0,30

Guarnizione Contatore Gas
per Flex Gomma Nera





Raccordo Ottone Giallo
Niples Maschio Filettato
Destro Sinistro

CODICE	MISURA	UM	PZ	€
001 072 024	D.1/2	PZ	10	2,60



Raccordo Dado Folle
Iniettore Ottone Giallo
Filettato

CODICE	MISURA	UM	PZ	€
001 072 025	D.1/4x1/2Sx	PZ	2	2,90



Flex Acqua Acciaio Inox
Antivibrante Estensibile
Maschio Femmina

CODICE	MISURA	UM	PZ	€
001 174 017	D.1/2x1/2 MF 110-210	PZ	10	8,20
001 174 018	D.1/2x1/2 MF 200-410	Pz	10	8,60
001 174 043	D.1/2x1/2 MF 260-520	PZ	10	10,90
001 174 016	D.1/2x3/4 MF 110-210	PZ	10	10,00
001 174 011	D.1/2x3/4 MF 200-410	PZ	10	16,10
001 174 045	D.1/2x3/4 MF 260-520	PZ	10	18,30
001 174 015	D.3/4x3/4 MF 110-210	PZ	10	11,60
001 174 007	D.3/4x3/4 MF 200-410	PZ	10	13,30
001 174 008	D.3/4x3/4 MF 260-520	PZ	10	18,20
001 174 025	D.1" x1" MF 110-210	PZ	10	23,00
001 174 026	D.1" x1" MF 200-410	PZ	10	28,10
001 174 027	D.1" x1" MF 260-520	PZ	10	29,70



Kit Flex Allacciamento
Caldaie Murali
4 acqua 1 Gas

CODICE	MISURA	UM	PZ	€
001 174 060	D.200/400	PZ	1	61,00



Tubi Flessibili
per Impianti
Solari Termici

CODICE	MISURA	UM	PZ	€
029 174 001	D.16x25mt	PZ	1	45,60
029 174 002	D.16x15mt	PZ	1	45,60
029 174 003	D.20x25mt	PZ	1	56,90
029 174 004	D.20x15mt	PZ	1	56,90
029 174 008	D.25x15mt	PZ	1	71,10



CODICE	MISURA	UM	PZ	€
002 048 006	Compl. Racc. 5 vie + Manometro + Pressostato	PZ	1	124,20

Sistema di Controllo Elettropompa Automatico Flowsystem



CODICE	MISURA	UM	PZ	€
002 048 003	2hP Matic Ass.20(8)A Pressione 10 Bar - D. 1"	PZ	1	85,40

Sistema di Controllo Elettropompa Automatico Elettronico **Hydromatic**



CODICE	MISURA	UM	PZ	€
002 048 004		PZ	1	42,50

Scheda per Sistema di Controllo Automatico Elettronico **Hydromatic**



CODICE	MISURA	UM	PZ	€
002 048 002	2hP Matic Ass.20(8)A Pressione 10 Bar - D. 1"	PZ	1	97,60

Sistema di Controllo Elettropompa Automatico Elettronico **Re-Start**



CODICE	MISURA	UM	PZ	€
002 048 100	D. 1"	PZ	1	54,70

Sistema di Controllo Elettropompa Automatico Elettronico **Pressure**



CODICE	MISURA	UM	PZ	€
002 048 101		PZ	1	41,00

Scheda Pressure Ricambio Elettronico



CODICE	MISURA	UM	PZ	€
002 087 067	D. 1"	PZ	1	832,90

Sistema di Controllo Elettropompa Automatico Elettronico Vsd Pentair





SETTORE 002

IDRAULICA



Vaso di Espansione
a Membrana in Materiale
Composito Wellmate

CODICE	MISURA	UM	PZ	€
002 087 110	Lt 55	PZ	1	349,40
002 087 111	Lt 75	PZ	1	390,70
002 087 112	Lt 112	PZ	1	553,80



Idrosfera a Membrana
Intercambiabile

CODICE	MISURA	UM	PZ	€
002 071 007	D.1" lt 25	PZ	1	35,40
002 071 052	D.1" lt 60	PZ	1	246,10
002 071 055	D.1" lt 100	PZ	1	304,70



Idrosfera a Membrana
Intercambiabile Orizzontale

CODICE	MISURA	UM	PZ	€
002 071 056	D.1" lt 60	PZ	1	252,70



Membrana per Idrosfera
Intercambiabile

CODICE	MISURA	UM	PZ	€
002 071 027	D.1" lt 24	PZ	10	7,50
002 071 028	D.1" lt 60/80/100	PZ	1	65,90



Idrosfera
a Membrana Fissa

CODICE	MISURA	UM	PZ	€
002 071 012	D.1" lt 5 Acqua Calda	PZ	10	50,60
002 071 030	D.1" lt 8 Acqua Calda	PZ	10	53,80
002 071 031	D.1" lt 24 Acqua Fredda	PZ	10	66,60



Pressostato
Square D

CODICE	MISURA	UM	PZ	€
002 071 019	Bar 4,20 D.1/4 FSG-2	PZ	10	18,60
002 071 040	Bar 6,50 D.1/4 FYG-22	PZ	10	45,50
002 071 041	Bar 9,50 D.1/4 FYG-32	PZ	10	43,50



Pressostato
Matic

CODICE	MISURA	UM	PZ	€
002 071 020	D.1/4 MPS1F1-5	PZ	1	15,10



Pressostato Monoblocco
con Tee 5 vie
Con Manometro

CODICE	MISURA	UM	PZ	€
002 032 001		PZ	1	30,50



CODICE	MISURA	UM	PZ	€
002 048 020	5 Ampere	PZ	1	152,80
002 048 021	8 Ampere	PZ	1	152,80
002 048 022	10 Ampere	PZ	1	152,80
002 048 023	14 Ampere	PZ	1	152,80

Quadro Elettrico Monofase
con Termica
Senza Condensatore



CODICE	MISURA	UM	PZ	€
002 048 007	mF 12,7 450 V	PZ	10	6,10
002 048 008	mF 16 450 V	PZ	10	7,10
002 048 009	mF 20 450 V	PZ	10	8,10
002 048 010	mF 30 450 V	PZ	10	11,30
002 048 011	mF 40 450 V	PZ	10	14,10
002 048 012	mF 50 450 V	PZ	10	16,50
002 048 013	mF 10-1,5 450 V	PZ	10	3,50
002 048 014	mF 10-2 450 V	PZ	10	3,50
002 048 015	mF 10-2,5 450 V	PZ	10	3,60
002 048 016	mF 10-3,5 450 V	PZ	10	3,80
002 048 017	mF 10-4 450 V	PZ	10	4,30

Condensatore
per Quadro Elettrico



CODICE	MISURA	UM	PZ	€
002 091 014	D.1"x72 Normale	PZ	1	10,50
002 091 018	D.1"x92 Prolungata	PZ	1	11,60

Raccordo a 5 Vie
per Autoclave



CODICE	MISURA	UM	PZ	€
002 091 015	1/4 D. 63 bar 0-12 Radiale	PZ	10	7,40
002 091 016	1/4 D. 63 bar 0-12 Centrale	PZ	10	8,80

Manometro di Pressione
Attacco Radiale e Centrale

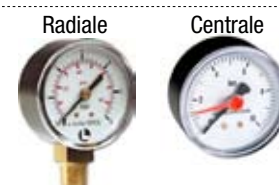

CODICE	MISURA	UM	PZ	€
002 071 034	D.1/2x3/4 Midi	PZ	1	167,20
002 071 035	D.1/2x3/4 Maxi	PZ	1	185,80

Alimentatore D'aria
Automatico con Flessibile



CODICE	MISURA	UM	PZ	€
002 071 033	D.1/2x3/4 Mini	PZ	1	78,70
002 071 036	D.1/2x3/4 Midi	PZ	1	140,80

Alimentatore D'aria
Automatico Senza Flessibile



CODICE	MISURA	UM	PZ	€
002 071 037	D.1/4Mx1/2F Cm 100	PZ	10	16,60
002 071 038	D.1/4Mx1/2F Cm 70	PZ	10	14,50

Flessibile per Alimentatore
D'aria Automatico



CODICE	MISURA	UM	PZ	€
002 082 001		PZ	10	28,90

Galleggiante Elettrico
Mini Matic



CODICE	MISURA	UM	PZ	€
002 087 030	D.1/2	PZ	10	53,80

Gruppo Indicatore di Livello
Con Guarnizioni



CODICE	MISURA	UM	PZ	€
002 087 031	D.16x2,5 mt	PZ	10	46,10

Tubo Acrilico per Gruppo
Indicatore di Livello





Mini Stazione di Sollevamento per Acque Sporche Wc

CODICE	MISURA	UM	PZ	€
002 087 005	DrainLift	PZ	1	816,40



Mini Stazione di Sollevamento Acque Sporche

CODICE	MISURA	UM	PZ	€
002 087 104	HiDrainLift 3.3.37	PZ	1	731,30



Filtro Autopulente Ottone Maglia 100 Micron Con Manometro RB

CODICE	MISURA	UM	PZ	€
002 087 001	D.1/2	PZ	1	128,80
002 087 002	D.3/4	PZ	1	140,00
002 087 003	D.1"	PZ	1	159,00



Cartuccia per Filtro RB Autopulente 100 Micron

CODICE	MISURA	UM	PZ	€
002 087 153	D.1"1/4 e D.1"1/2	PZ	1	194,60



Cartuccia per Filtro Autopulente Ottone Itap

CODICE	MISURA	UM	PZ	€
002 087 155	D.1"1/4	PZ	1	23,40
002 087 156	D.1"1/2	PZ	1	30,80



Filtro Autopulente Ottone Maglia 100 Micron Con Manometro te-sa

CODICE	MISURA	UM	PZ	€
002 146 001	D.1/2	PZ	1	133,30
002 146 002	D.3/4	PZ	1	142,30
002 146 003	D.1"	PZ	1	158,50
002 146 004	D.1"1/4	PZ	1	148,30
002 146 005	D.1"1/2	PZ	1	183,80
002 146 006	D.2"	PZ	1	185,40



Defangatore Far Ultra Compatto C/Magnete per Impianti Termici

CODICE	MISURA	UM	PZ	€
019 144 116	D.3/4 FF	PZ	1	146,10



CODICE	MISURA	UM	PZ	€
002 087 009	D.1" F	PZ	10	30,10

Contenitore Filtro 10"
Attacco Femmina



CODICE	MISURA	UM	PZ	€
002 087 078	D.3/4	PZ	10	23,80
002 087 080	D.1"	PZ	10	29,50

Bicchiere
per Contenitore Filtro 10"



CODICE	MISURA	UM	PZ	€
002 087 015	D.3/4	PZ	10	28,00

Contenitore Filtro 5"
Attacco Femmina



CODICE	MISURA	UM	PZ	€
002 087 039	D.1"	PZ	10	5,10

Chiave per Contenitore
Filtro 10"



CODICE	MISURA	UM	PZ	€
002 087 019	D.10"	PZ	10	15,00
002 087 026	D.5"	PZ	10	13,40

Cartuccia Filtro Rete Inox
per Contenitore Filtro



CODICE	MISURA	UM	PZ	€
002 087 014	D.10"	PZ	10	9,30
002 087 025	D.5"	PZ	10	7,50

Cartuccia Filtro Filo Avvolto
per Contenitore Filtro



CODICE	MISURA	UM	PZ	€
002 087 012	D.10"	PZ	10	24,90
002 087 053	D.5"	PZ	10	15,70

Cartuccia Filtro Polifosfati
per Contenitore Filtro



CODICE	MISURA	UM	PZ	€
002 087 013	D.10"	PZ	10	15,20

Cartuccia Filtro Carboni
Attivi per Contenitore
Filtro 10"



CODICE	MISURA	UM	PZ	€
002 093 001	Lt 24	PZ	1	1778,90

Addolcitore Cabinato
con Timer Gel Max





Contenitore Filtro 10"
Attacco D.3/4 Femmina
Trasparente Global

CODICE	MISURA	UM	PZ	€
002 088 001	D.3/4 X 10"	PZ	10	23,30



Contenitore Filtro 10"
Attacco D.3/4 Femmina
Bianco Global

CODICE	MISURA	UM	PZ	€
002 088 002	D.3/4 X 10"	PZ	10	19,50



Cartuccia Filtro
per Contenitore Filtro 10"
Global 10 micron

CODICE	MISURA	UM	PZ	€
002 088 005	10" Slim Polisediment	PZ	10	4,10
002 088 006	10" Slim Carboni Attivi	PZ	10	15,70



Chiave per Contenitore
Filtro Global

CODICE	MISURA	UM	PZ	€
002 088 010	10"	PZ	10	5,50



Sistema Osmosi Inversa
220V-24V 1,2A + Vaso TP-4
D.1/4 Global

CODICE	MISURA	UM	PZ	€
002 088 015	D.1/4	PZ	10	698,20



Vaso di Espansione a
Membrana Diaframma Global
Pressura Wave

CODICE	MISURA	UM	PZ	€
002 088 020	Lt 24	PZ	10	69,80



Vaso di Espansione a
Membrana Diaframma Global
RoWave

CODICE	MISURA	UM	PZ	€
002 088 025	Lt 4	PZ	10	69,30



Dosatore Silicopolifosfato
in Polvere Anti Calcare
Corrosione
con Ricarica

CODICE	MISURA	UM	PZ	€
002 093 010	D.1/2 Dosatore	PZ	1	119,70
002 093 011	D.1/2 Ricarica	PZ	1	23,10



Dosatore Silicopolifosfato
Sali Minerali Anti Calcare
Corrosione
con Ricarica

CODICE	MISURA	UM	PZ	€
002 093 014	D.3/4 Ecophos	PZ	1	206,70
002 093 015	D.3/4	PZ	1	41,40



CODICE	MISURA	UM	PZ	€
002 032 050	Hp 0,8 Kw 0,6	PZ	1	924,60
002 032 051	Hp 1,00 Kw 0,75	PZ	1	950,10

Pompa Sommersibile
Monoblocco
per Acque Sporche



CODICE	MISURA	UM	PZ	€
002 032 030	Hp 0,42 Kw 0,32	PZ	1	294,30
002 032 032	Hp 0,60 Kw 0,45	PZ	1	335,70
002 032 037	Hp 1,00 Kw 0,75	PZ	1	360,60

Pompa Sommersibile
Drenaggio
per Acque Chiare



CODICE	MISURA	UM	PZ	€
002 032 060	Hp 1,5 Kw 1,10	PZ	1	1624,20
002 032 061	Hp 1,00 Kw 0,75	PZ	1	1236,30
002 032 062	Hp 1,5 Kw 1,10	PZ	1	1551,50
002 032 063	Hp 1,50 Kw 1,10	PZ	1	1570,10

Pompa a Motore Sommerso
4" Multistadio
per Acque Chiare



CODICE	MISURA	UM	PZ	€
002 032 070	Hp 0,72 Kw 0,55	43	1	1807,90
002 032 071	Hp 1,00 Kw 0,75	PZ	1	1072,60
002 032 072	Hp 1,45 Kw 1,10	PZ	1	1131,30

Pompa a Motore Sommerso
5" Multistadio
per Acque Chiare



CODICE	MISURA	UM	PZ	€
002 032 055	Hp 1,00 Kw 0,90	PZ	1	290,10

Elettropompa Sommersibile
per Drenaggio
Intial Waster



CODICE	MISURA	UM	PZ	€
002 032 080	Hp 0,50 Kw 0,37	PZ	1	1361,00
002 032 081	Hp 0,72 Kw 0,55	PZ	1	1501,20
002 032 082	Hp 1,00 Kw 0,75	PZ	1	1680,10

Pompa a Motore Sommerso
3" Multistadio
per Acque Chiare





SETTORE 002

IDRAULICA



Elettropompa di Circolazione ad Alta Efficienza Yonos-Pico

CODICE	MISURA	UM	PZ	€
002 032 040	H 2 Mt 1,5 Mc/h Int.130	PZ	1	364,70
002 032 041	H 3 Mt 2 Mc/h Int.130	PZ	1	410,40
002 032 042	H 5 Mt 2,5 Mc/h Int. 180	PZ	1	551,20
002 032 043	H 5,8 Mt 2 Mc/h Int. 130	PZ	1	456,20
002 032 044	H 5,7 Mt 2 Mc/h Int. 180	PZ	1	525,20



Elettropompa di Circolazione Alta Efficienza Yonos-Para

CODICE	MISURA	UM	PZ	€
002 032 046	A 3 Mt 2 Mc/h Int.130 25-1-6 130	PZ	1	217,60



Elettropompa di Circolazione Alta Efficienza Max-Yonos

CODICE	MISURA	UM	PZ	€
002 032 047	30-0,5-7 180	PZ	1	1072,50



Elettropompa di Circolazione ad Alta Efficienza Star-Stg per Solare

CODICE	MISURA	UM	PZ	€
002 032 048	Int.130	PZ	1	455,90



Elettropompa di Circolazione ad Alta Efficienza Star

CODICE	MISURA	UM	PZ	€
002 071 082	INT.180 D.1" 1,7mt>16,66lt/min.	PZ	1	736,30



Bocchettoni Ottone per pompe di Circolazione Coppia

CODICE	MISURA	UM	PZ	€
002 071 061	D.1"1/2x1" F. (2 Dadi + 2 Coduli + 2 Guarnizioni)	PZ	10	14,90
002 071 009	2"x1"1/4 F. (2 Dadi + 2 Coduli + 2 Guarnizioni)	PZ	10	19,40



CODICE	MISURA	UM	PZ	€
002 032 010	S/MANIGL.AUTOD.ACCIAIO KW 0,65	PZ	1	331,60
002 032 011	S/MANIGL.AUTOD.ACCIAIO KW 0,75	PZ	1	356,40
002 032 012	S/MANIGL.AUTOD.ACCIAIO KW 1,1	PZ	1	402,00

Elettropompa Centrifuga
Monostadio Autoaspirante
Acciaio



CODICE	MISURA	UM	PZ	€
002 032 020	1x230 WILO 4032125 MULTI. KW 0,55 0,75hp	PZ	1	414,40
002 032 021	1x230 WILO 4032127 MULTISTADIO KW 0,75	PZ	1	513,90
002 032 028	1x230 WILO 4032133 MULTISTADIO KW 1,1	PZ	1	654,80

Elettropompa Centrifuga
Multistadio Autoaspirante
Acciaio



CODICE	MISURA	UM	PZ	€
002 087 038	Hp1.2 Kw1,2	PZ	1	660,70

Elettropompa Sommersa
PratikaAutomatica M 220V
Nocchi Hp1.2 Kw1,2



CODICE	MISURA	UM	PZ	€
002 087 100	CPS/20 MULTINOX 120/60	PZ	1	4091,00

Gruppo di Pressione
Monofase Inverter
Con Quadro Elettrico



CODICE	MISURA	UM	PZ	€
002 087 057	HP2x1,5 8010583375046 UP3105F0 NOCCHI	PZ	1	1967,80

Gruppo di Pressione
Monofase Pressotato
Con Quadro Elettrico



CODICE	MISURA	UM	PZ	€
002 087 095	HP2x1,1 PMS20VA UC4004E0 Nocchi Multi Evo 5-60M	PZ	1	2354,70
002 087 097	HP2x1,25 UC4005E0 Nocchi Multi Evo 5-50M	PZ	1	2081,70
002 032 028	1x230 WILO 4032133 Multistadio KW 1,1	PZ	1	654,80

Gruppo di Pressione
Monofase Pressotato
Con Quadro Elettrico



CODICE	MISURA	UM	PZ	€
002 032 005	Hp 0,80 Kw 0,6	PZ	1	232,10
002 032 006	Hp 1 Kw 0,75	PZ	1	273,50
002 032 007	Hp 1,5 Kw 1,1	PZ	1	310,80
002 032 008	Hp 2 Kw 1,5	PZ	1	692,10

Elettropompa
Autoadescante in Ghisa



CODICE	MISURA	UM	PZ	€
002 087 004	Hp 0,5 Kw 0,37	PZ	1	124,40

Elettropompa Periferica
in Ghisa



CODICE	MISURA	UM	PZ	€
002 083 006	Hp 0,50 Kw 0,37 - PK M 60	PZ	1	134,10

Elettropompa Periferica
in Ghisa Pedrollo





SETTORE 002



Elettropompa Multigirante in Ghisa Pedrollo

CODICE	MISURA	UM	PZ	€
002 083 001	3 CPM 80C Hp 0,50 Kw 0,60	PZ	1	260,10
002 083 002	4 CPM 80C Hp 0,85 Kw 0,60	PZ	1	288,50
002 083 003	4 CPM 100C Hp 1 Kw 0,75	PZ	1	341,30

IDRAULICA



Elettropompa Autodescante in Ghisa Jet Pedrollo

CODICE	MISURA	UM	PZ	€
002 083 010	JWM1 BX - Hp 0,70 Kw 0,50	PZ	1	223,50
002 083 011	JSWM 2C - Hp 1 Kw 0,75	PZ	1	268,00
002 083 012	JSWM 2A - Hp 1,5 Kw 1	PZ	1	300,70



Elettropompa Sommergibile Drenaggio Pedrollo Top Multi2

CODICE	MISURA	UM	PZ	€
002 083 020	Hp 0,50 Kw 0,37	PZ	1	432,00



Elettropompa Sommersa 4" Pedrollo per Acque Chiare

CODICE	MISURA	UM	PZ	€
002 083 030	Hp 1 Kw 0,75	PZ	1	674,60
002 083 031	Hp 1,5 Kw 1,1	PZ	1	742,30



Elettropompa di Rilancio per Acqua Fredda Jolly Pump Matic

CODICE	MISURA	UM	PZ	€
002 048 018	12 Mt	PZ	1	328,10



Elettropompa per Gasolio

CODICE	MISURA	UM	PZ	€
002 087 105	HP 0,50 Kw 0,37	PZ	1	283,40



Pistola con Tubo per Elettropompa Gasolio

CODICE	MISURA	UM	PZ	€
002 087 106	4 Mt	PZ	1	116,00



CODICE	MISURA	UM	PZ	€
002 087 070	3-30 Hp 0,87 Kw 0,65	PZ	1	321,20
002 087 071	3-40 Hp 1,1 Kw 0,8	PZ	1	328,90
002 087 072	3-40 Hp 1,5 Kw 1,1	PZ	1	375,20
002 087 073	5-50 Hp 1,8 Kw 1,35	PZ	1	421,50

Elettropompa
Multigirante
Multi Evo - Nocchi



CODICE	MISURA	UM	PZ	€
002 087 121	3-50 HP 1,34 Kw 1	PZ	1	1454,50
002 087 126	3-60 Hp 2,4 Kw 1,8	PZ	1	1763,20

Elettropompa Inverter
Multigirante
Multi Evo-E - Nocchi



CODICE	MISURA	UM	PZ	€
002 087 041	3-40 Hp 1,1 Kw 0,8	PZ	1	299,50
002 087 042	5-50 Hp 1,8 Kw 1,35	PZ	1	387,50

Elettropompa Multi Evo-SP
Multigirante
Nocchi



CODICE	MISURA	UM	PZ	€
002 087 049	Plus 75/75 M - Hp 1.5 Kw 1,1	PZ	1	693,00
002 087 050	Plus 115/70 M - Hp 1.8 Kw 1,3	PZ	1	757,40

Elettropompa Sommersa
Dominator 4"
Nocchi



CODICE	MISURA	UM	PZ	€
002 087 083	115/65 M - HP 1 Kw 0,75	PZ	1	910,40

Elettropompa Sommersa
SCM4PLUS
Centrifuga Nocchi



CODICE	MISURA	UM	PZ	€
002 087 047	200/8M Auto - Hp 0.7 Kw0,5	PZ	1	531,80

Elettropompa Drenaggio
Acque Sporche Omnia
Nocchi



CODICE	MISURA	UM	PZ	€
002 087 048	460/13M Auto - Hp 1.5 Kw 11	PZ	1	761,70

Elettropompa Drenaggio
Acque Reflue PRIOX
Nocchi





SETTORE 002

IDRAULICA



Elettropompa Drenaggio
Acque Reflue BIOX
Nocchi

CODICE	MISURA	UM	PZ	€
002 087 034	Hp 0,8 Kw 0,6 250/9 XS M Auto.V230	PZ	1	532,40
002 087 087	Hp 1,2 Kw 0,9 350/11 XS M - Auto. V230	PZ	1	560,40



Elettropompa Drenaggio
Acque Sporche DPV
Nocchi

CODICE	MISURA	UM	PZ	€
002 087 089	160/6 M Auto - Hp 0.56 Kw 0,41	PZ	1	229,30



Elettropompa Drenaggio
Acque Chiare DP
Nocchi

CODICE	MISURA	UM	PZ	€
002 087 092	180/7 Auto - Hp 0.4 Kw 0,3	PZ	1	231,60



Elettropompa Drenaggio
Acque Scure FP7KVG M
Flotec Nocchi

CODICE	MISURA	UM	PZ	€
002 087 115	Kw 350	PZ	1	130,10



Elettropompa Drenaggio
Acque Sporche FP14KVX M
Nocchi

CODICE	MISURA	UM	PZ	€
002 087 116	Hp0.56 W 600	PZ	1	237,30



Pompa Condensa Caldaia
K2 Plus Jung

CODICE	MISURA	UM	PZ	€
002 087 108	Hmax 4,5mt Qmax520 l/h	PZ	1	386,00



Giunto Elastico
di Compensazione
Antivibrante Zincato

CODICE	MISURA	UM	PZ	€
001 017 020	D.3/4	PZ	10	32,60
001 017 021	D.1"	PZ	10	35,40
001 017 022	D.1"1/4	PZ	10	44,50
001 017 023	D.1"1/2	PZ	10	51,60
001 017 024	D.2"	PZ	10	65,50
001 017 025	D.2"1/2	PZ	10	108,90
001 017 026	D.3"	PZ	10	147,10



CODICE	MISURA	UM	PZ	€
003 001 003	1/2 D.3/4	CF	100	5,10
003 001 004	3/4 D.1"	CF	100	9,80
003 001 005	1" D.1"1/4	CF	100	14,10

Guarnizione per Raccordi
Contatore Acqua



CODICE	MISURA	UM	PZ	€
003 001 008	D.3/8	PZ	100	0,20
003 001 009	D.1/2	PZ	100	0,40
003 001 010	D.3/4	PZ	100	0,80
003 001 011	D.1"	PZ	100	0,60
003 001 012	D.1"1/4	PZ	100	0,60
003 001 013	D.1"1/2	PZ	100	1,00

Guarnizione Conica Gomma
Bianca per Piletta



CODICE	MISURA	UM	PZ	€
003 001 014	D.1/2	PZ	100	0,40
003 001 015	D.3/4	PZ	100	0,50
003 001 016	D.1"	PZ	100	0,50
003 001 017	D.1"1/4	PZ	100	0,90
003 001 018	D.1"1/2	PZ	100	1,00

Guarnizione Conica
C/Bordino Gomma Bianca
per Piletta



CODICE	MISURA	UM	PZ	€
003 001 007	D.3/8x10	CF	100	5,40
003 001 019	D.1/2x12	CF	100	8,50
003 001 020	D.3/4 x26	CF	100	16,20
003 001 021	D.1" x30	CF	100	22,30
003 001 022	D.1"1/4x32	CF	100	24,30
003 001 023	D.1"1/2x40	CF	100	33,80

Guarnizione Conica
Gomma Nera per Cannette



CODICE	MISURA	UM	PZ	€
003 006 022	D.3/8	CF	10	5,10
003 006 023	D.1/2	CF	10	6,00

Guarnizione per Sede
Vitone Rubinetto
Gomma Nera



CODICE	MISURA	UM	PZ	€
003 006 035	D.3/8	PZ	10	0,30
003 006 036	D.1/2	PZ	10	0,10

Guarnizione per Sede
Galleggiante Catis
Gomma Nera



CODICE	MISURA	UM	PZ	€
003 001 049		PZ	10	17,80

Cassetta O-Ring
Anelli Assortiti
Misure Medie





Guarnizione Batteria
Sifone Catis Gomma Nera
con Nottolino

CODICE	MISURA	UM	PZ	€
003 006 037		PZ	50	1,60



Guarnizione Batteria
Sifone Catis Gomma Nera
Senza Nottolino

CODICE	MISURA	UM	PZ	€
001 155 010		PZ	50	1,20



Guarnizione Sede Piana
in Gomma Nera
Spessore 2 mm
Confezione 100 pz

CODICE	MISURA	UM	PZ	€
003 001 030	D.3/8	CF	100	2,10
003 001 031	D.1/2	CF	100	2,10
003 001 032	D.3/4	CF	100	3,80
003 001 033	D.1"	CF	100	6,60
003 001 034	D.1"1/4	CF	100	10,30
003 001 035	D.1"1/2	CF	100	12,10
003 001 036	D.2"	CF	100	14,20



Guarnizione per Resistenza
Flangiata per Scaldacqua
Grandi It Tonda

CODICE	MISURA	UM	PZ	€
003 101 005		PZ	10	8,50



Guarnizione per Resistenza
Flangiata per Scaldacqua
Grandi It Ovale

CODICE	MISURA	UM	PZ	€
003 101 006		PZ	10	2,40



Guarnizione per Resistenza
Flangiata per Scaldacqua
Piccoli It Ovale

CODICE	MISURA	UM	PZ	€
003 101 007		PZ	10	2,30



Guarnizione Esente Amianto
per Flessibili
Confezione 100 pz

CODICE	MISURA	UM	PZ	€
003 074 022	D.3/8	CF	100	2,40
003 074 014	D.1/2	CF	100	3,10
003 074 015	D.3/4	CF	100	4,10
003 074 016	D.1"	CF	100	3,60
003 074 017	D.1"1/4	CF	100	10,10
003 074 023	D.1"1/2	CF	100	12,60
003 074 024	D.2"	CF	100	25,70



Guarnizione Carta
per Radiatori Ghisa
Confezione 100 pz

CODICE	MISURA	UM	PZ	€
003 074 010	D.1"	CF	100	2,20
003 074 011	D.1"1/4	CF	100	2,70

CODICE	MISURA	UM	PZ	€
003 074 020	D.1"	CF	100	15,80
003 074 021	D.1"1/4	CF	100	18,90

Guarnizione Esente Amianto
per Radiatori Ghisa



CODICE	MISURA	UM	PZ	€
003 074 018	D.1"	CF	100	12,80
003 074 019	D.1"	CF	100	9,40

Guarnizione Esente Amianto
per Radiatori Alluminio
Aggiunzioni



CODICE	MISURA	UM	PZ	€
003 074 030	D.1"x1,5	CF	100	39,50
003 074 031	D.1"x2,5	CF	100	41,90

Guarnizione EPDM
per Radiatori Alluminio
Aggiunzioni



CODICE	MISURA	UM	PZ	€
003 101 001	D.53x42x4	CF	100	33,80
003 101 002	D.42x35x4	CF	100	29,20
003 101 097		CF	100	33,80

Guarnizione in Gomma
per Resistenza Scaldacqua



CODICE	MISURA	UM	PZ	€
003 074 025	D.1/2	CF	100	8,50

Guarnizione
per Gas in Cuoio



CODICE	MISURA	UM	PZ	€
003 074 026	D.1/2	CF	100	11,10

Guarnizione
per Gas in Gomma Nera



CODICE	MISURA	UM	PZ	€
001 174 019	D.1/2	CF	20	9,00

Guarnizione
per Gas in Alluminio





Manicotto Attacco Wc
Diritto Gomma Bianca

CODICE	MISURA	UM	PZ	€
003 084 017	D. 110	PZ	10	2,00



Manicotto Attacco Wc
Diritto Gomma Nera

CODICE	MISURA	UM	PZ	€
003 084 020	D. 110	PZ	10	8,20



Manicotto Attacco Wc
Eccentrico Gomma Nera

CODICE	MISURA	UM	PZ	€
003 084 021	D. 110	PZ	10	11,20



Manicotto Attacco Wc
Eccentrico Gomma Bianca

CODICE	MISURA	UM	PZ	€
003 084 010	D. 110	PZ	10	2,00



Manicotto Attacco Wc
Eccentrico Cm 4 Gomma
Bianca

CODICE	MISURA	UM	PZ	€
003 084 011	Cm 4 - D. 110	PZ	10	4,90



Manicotto Attacco Wc
Diritto Flessibile Gomma
Bianca

CODICE	MISURA	UM	PZ	€
003 084 018	D. 110	PZ	10	8,90



Morsetto Wc
Gomma Bianca
per Attacco Vaso

CODICE	MISURA	UM	PZ	€
003 001 056	D.30x50	PZ	50	0,60
003 001 060	D.30x55	PZ	50	1,20
003 001 057	D.30x60	PZ	50	0,70
003 001 058	D.40x45x55	PZ	50	1,20
003 001 059	D.40x45x60	PZ	50	1,40



Morsetto per Curva Tecnica
Scarico Nero

CODICE	MISURA	UM	PZ	€
003 006 032	D.40x26-30-32	PZ	50	0,50
003 006 033	D.50x26-30-32	PZ	50	0,80
003 006 038	D.50x40	PZ	50	0,60



Morsetto per Curva Tecnica
Scarico Nero

CODICE	MISURA	UM	PZ	€
003 006 031	D.46x26-32 Tipo Valsir	PZ	50	0,60
003 006 045	D.46x40 Tipo Valsir	PZ	50	0,40
003 006 046	D.53x26-32 Tipo Valsir	PZ	50	1,50
003 006 047	D.53x40 Tipo Valsir	PZ	50	1,10



Morsetto Scarico Condensa
Nero

CODICE	MISURA	UM	PZ	€
003 006 048	D.32X18-26	PZ	50	0,50



CODICE	MISURA	UM	PZ	€
003 084 012	D.1/2 - Rosso	PZ	10	0,70
003 084 013	D.1/2 - Blu	PZ	10	0,70

Tappo Prova Impianto
con Filetto in Plastica



CODICE	MISURA	UM	PZ	€
003 084 014	D.1/2 - Rosso	PZ	10	2,00
003 084 015	D.1/2 - Blu	PZ	10	2,00

Tappo Prova Impianto
con Filetto in Ottone Rosso



CODICE	MISURA	UM	PZ	€
003 163 005	D.18x6	ML	240	1,40
003 163 001	D.22x6	ML	194	1,50
003 163 003	D.27x6	ML	136	1,80
003 163 002	D.34x6	ML	106	2,00
003 189 005	D.18x6 Armacell	ML	210	0,80
003 189 001	D.22x6 Armacell	ML	166	0,90
003 189 003	D.28x6 Armacell	ML	112	1,20
003 189 002	D.35x6 Armacell	ML	92	1,30

Tubo Isolante
per Riscaldamento
Spessore 6 mm



CODICE	MISURA	UM	PZ	€
003 163 008	D.18x10	ML	100	1,60
003 163 009	D.22x10	ML	100	2,00
003 163 010	D.27x10	ML	94	2,90
003 163 011	D.34x10	ML	94	4,20
003 189 008	D.18x9 Armacell	ML	140	0,26
003 189 009	D.22x9 Armacell	ML	136	0,27
003 189 010	D.28x9 Armacell	ML	98	0,37
003 189 011	D.35x9 Armacell	ML	72	0,40
003 189 012	D.42x9 Armacell	ML	60	0,46
003 189 013	D.48x9 Armacell	ML	50	0,52
003 189 014	D.60x9 Armacell	ML	44	0,68

Tubo Isolante
per Refrigerazione Spessore
10 mm



CODICE	MISURA	UM	PZ	€
003 163 004	H 50 mm x 10 mt Riscaldamento	PZ	24	15,10
003 163 007	H 50 mm x 50 mt Alluminio Grigio	PZ	24	18,70

Nastro Adesivo Isolante
Riscaldamento
e Raffrescamento



CODICE	MISURA	UM	PZ	€
003 163 006	H 50 mm x 10 mt	PZ	10	15,10

Nastro Adesivo Isolante per
Clima - Bianco



CODICE	MISURA	UM	PZ	€
003 168 001	D.20	ML	25	1,40
003 168 002	D.25	ML	25	1,70
003 168 003	D.30	ML	25	2,20
003 168 006	D.35	ML	25	2,60
003 168 007	D.40	ML	25	3,30

Tubo Guaina Spirolato Pvc
per Gas - Giallo



CODICE	MISURA	UM	PZ	€
003 168 004	D.16	ML	25	1,40
003 168 009	D.18	ML	30	1,70
003 168 005	D.20	ML	25	1,30

Tubo Guaina Spirolato Pvc
per Condensa - Grigio





Pasta Verde
per Aggiunzioni e Raccordi

CODICE	MISURA	UM	PZ	€
004 001 005	gr 450	PZ	10	3,30



Canapa Pettinata

CODICE	MISURA	UM	PZ	€
004 001 006	Kg 1	Kg	1	11,80



Canapa Rocchetto

CODICE	MISURA	UM	PZ	€
004 001 007	gr 80	PZ	1	6,80



Teflon Rotolo PTF
per Acqua

CODICE	MISURA	UM	PZ	€
004 001 024	D.12x10 Mt x0,076 mm	PZ	200	0,40



Teflon Rotolo PTF
per Acqua

CODICE	MISURA	UM	PZ	€
004 001 022	D.19x12 Mt x0,076 mm	PZ	100	0,80



Teflon Rotolo PTF
per Gas

CODICE	MISURA	UM	PZ	€
004 001 025	D.19x15 Mt x0,20 mm	PZ	25	1,90
004 001 027	D.12x12 Mt x0,10 mm	PZ	80	0,50



Teflon Rotolo PTF
Alta Densità Silicon Tape
per Acqua

CODICE	MISURA	UM	PZ	€
004 005 001	D.14x15 mt	PZ	10	13,00



SALDAKit Bicomponente
Universale

CODICE	MISURA	UM	PZ	€
004 001 010	gr 60	PZ	10	9,00



Boomboletta Spray
Rivelazione Fughe Gas

CODICE	MISURA	UM	PZ	€
004 001 001	gr 400	PZ	10	9,00



CODICE	MISURA	UM	PZ	€
004 005 007	Lt. 5	PZ	1	70,50
004 005 005	Lt. 1	PZ	1	27,70

Liquido per lavaggio impianti di riscaldamento Antinex+ Thermakil - Facot



CODICE	MISURA	UM	PZ	€
004 005 025	Lt 1	PZ	1	48,50

Risanante per Impianti di Riscaldamento



CODICE	MISURA	UM	PZ	€
004 005 003	Lt 5	PZ	1	110,40
004 005 005	Lt 1	PZ	1	27,70

Liquido per Impianti di Riscaldamento



CODICE	MISURA	UM	PZ	€
004 005 006	Lt 1	PZ	10	12,00

Disotturatore Professionale per Water e Lavelli



CODICE	MISURA	UM	PZ	€
004 005 026	Kg 5	PZ	1	27,50

Disincrostante per Scambiatori Rame e Acciaio



CODICE	MISURA	UM	PZ	€
004 005 002	Lt 10	PZ	1	105,20
004 005 009	Lt 5	PZ	1	54,50

Liquido Glicole per Impianti Solari



CODICE	MISURA	UM	PZ	€
004 005 028	Lt/min 28	PZ	1	815,60

Pompa Disincrostante con Invertitore di Flusso Baby 13



CODICE	MISURA	UM	PZ	€
004 005 015	ml 400	PZ	1	24,00

Detergente Antibatterico per Filtri Condizionatori



CODICE	MISURA	UM	PZ	€
004 005 016	ml 600	PZ	1	29,40

Detergente Schiumogeno per Batteria Condizionatori





Collante Tangit
per Incollaggio Tubi Pvc
Tubetto

CODICE	MISURA	UM	PZ	€
004 062 002	gr 125	PZ	12	16,70



Collante Tangit
per Incollaggio Tubi Pvc
Barattolo

CODICE	MISURA	UM	PZ	€
004 062 001	gr 250	PZ	12	21,00
004 062 014	gr 500	PZ	1	38,10
004 062 015	gr 1000	PZ	1	62,50



Collante Rosso
Per Tubi Pvc Tubetto

CODICE	MISURA	UM	PZ	€
004 005 011	gr 125	PZ	50	3,60



Scivolina Lubrificante
per Tubi e Raccordi
in PP Tubetto

CODICE	MISURA	UM	PZ	€
009 022 064	gr 250	PZ	50	4,70



Scivolina Lubrificante
per Tubi e Raccordi in PP
Bomboletta

CODICE	MISURA	UM	PZ	€
004 005 010	ml 400	PZ	12	9,70



Filo Tangit
per Tenuta Filetti Idraulici

CODICE	MISURA	UM	PZ	€
004 062 019	ml 80	PZ	20	20,50



Super Attack
Original Henkel

CODICE	MISURA	UM	PZ	€
004 062 030	gr 3	PZ	24	7,10



Super Attack
Power Flex Gel Henkel

CODICE	MISURA	UM	PZ	€
004 062 031	gr 3	PZ	24	8,20



Sigillante
per Filetti Idraulici Henkel

CODICE	MISURA	UM	PZ	€
004 062 018	ml 50	PZ	12	51,10



CODICE	MISURA	UM	PZ	€
004 005 020	ml 400	PZ	6	11,70

Olio Minerale per Filettature



CODICE	MISURA	UM	PZ	€
004 062 025	ml 75	PZ	10	10,50

Sigillante Anaerobico per Tenuta Filetti Idraulici



CODICE	MISURA	UM	PZ	€
004 062 013	ml 750	PZ	12	13,80

Schiuma Poliuretanicca Bomboletta Henkel



CODICE	MISURA	UM	PZ	€
004 062 011	ml 280	PZ	25	4,10

Silicone Trasparente Pattex Henkel



CODICE	MISURA	UM	PZ	€
004 062 012	ml 280	PZ	25	4,20

Silicone Bianco Pattex Henkel



CODICE	MISURA	UM	PZ	€
004 062 023	ml 300	PZ	25	4,10

Silicone Bianco Acrilico



CODICE	MISURA	UM	PZ	€
004 062 008	ml 500	PZ	12	16,10

Silicone Refrettario Grigio Pattex Henkel



CODICE	MISURA	UM	PZ	€
004 062 010	ml 300	PZ	12	16,40

Silicone Bagno Sano Bianco Pattex Henkel



CODICE	MISURA	UM	PZ	€
004 062 007	ml 100 x 12 Pz	PZ	12	12,00

Silicone Speciale Bianco Pattex Blister





SETTORE 004
IDRAULICA



Silicone Alta Temperatura
Rosso Pattex Henkel

CODICE	MISURA	UM	PZ	€
004 062 020	ml 300	PZ	12	18,70
004 062 021	ml 300	PZ	12	16,90



Silicone Neutro
Serramenti

CODICE	MISURA	UM	PZ	€
004 062 022	ml 300 - Fusion SL620 Testa di Moro	PZ	6	9,90



Pattex Ripara Smalto
per Porcellana

CODICE	MISURA	UM	PZ	€
004 062 032	gr 50	PZ	6	11,80



Pattex Riparatutto
per Metalli e Tubi

CODICE	MISURA	UM	PZ	€
004 062 033	gr 50	PZ	6	15,60



Silicone Trasparente
Pattex Henkel Blister

CODICE	MISURA	UM	PZ	€
004 062 017	ml 50	PZ	24	4,50



Silicone Bianco
Pattex Henkel Blister

CODICE	MISURA	UM	PZ	€
004 062 024	ml 60	PZ	24	4,50



Ancorante Chimico
Bicomponente Henkel

CODICE	MISURA	UM	PZ	€
004 062 035	ml 300	PZ	12	14,50



Collante Mastice
per Tubi Pvc
Pattex Henkel Tubetto

CODICE	MISURA	UM	PZ	€
004 062 004	gr 125	PZ	12	6,50



Collante Mastice per Tubi Pvc
Pattex Henkel Barattolo

CODICE	MISURA	UM	PZ	€
004 062 003	gr 850	PZ	12	20,10

CODICE	MISURA	UM	PZ	€
005 084 027	Bianco	PZ	6	8,80

Sedile Universale in Pvc
Leggero



CODICE	MISURA	UM	PZ	€
005 162 022	M94 Bianco	PZ	6	24,40

Sedile Universale in Pvc
Termoindurente



CODICE	MISURA	UM	PZ	€
005 175 010	Bianco	PZ	6	37,30

Sedile Universale in Pvc
Pesante



CODICE	MISURA	UM	PZ	€
005 175 001	Pegaso Bianco	PZ	6	30,50

Sedile Universale in Legno



CODICE	MISURA	UM	PZ	€
005 175 009	Tirreno Bianco	PZ	1	73,20

Sedile Universale in Legno
Disabili



CODICE	MISURA	UM	PZ	€
005 101 027		PZ	10	6,50

Coppie Cerniere Sedile
Cromate



CODICE	MISURA	UM	PZ	€
005 101 028		PZ	10	1,10

Coppie Cerniere Sedile in Pvc



CODICE	MISURA	UM	PZ	€
005 162 023	HH 260 CIAM 36X40 Bianco	PZ	1	68,20

Sedile per Disabili
Ciambella Rialzata



CODICE	MISURA	UM	PZ	€
005 080 001	Bianco	PZ	1	56,90

Sedile Soft Close Duroplast
Universale Bianco





Valvola a Leva
Femmina Femmina

CODICE	MISURA	UM	PZ	€
006 100 001	D.3/8 1700 R.B.	PZ	10	7,90
006 100 002	D.1/2 1500 R.B.	PZ	10	6,30
006 100 003	D.3/4 1500 R.B.	PZ	10	10,40
006 100 004	D.1" 1500 R.B.	PZ	10	14,40
006 100 005	D.1"1/4 1500 R.B.	PZ	1	27,10
006 100 006	D.1"1/2 1500 R.B.	PZ	1	35,80
006 100 007	D.2" 1500 R.B.	PZ	1	53,30
006 100 090	D.2"1/2 1500 R.B.	PZ	1	138,00
006 100 091	D.3" 1500 R.B.	PZ	1	207,60
006 100 092	D.4" 1500 R.B.	PZ	1	345,90



Valvola a Leva
Maschio Femmina

CODICE	MISURA	UM	PZ	€
006 100 015	D.1/2 1501 R.B.	PZ	10	7,00
006 100 016	D.3/4 1501 R.B.	PZ	10	11,30
006 100 017	D.1" 1501 R.B.	PZ	10	15,60
006 100 058	D.1"1/4 1501 R.B.	PZ	1	29,30
006 100 059	D.1"1/2 1501 R.B.	PZ	1	40,30
006 100 078	D.2" 1501 R.B.	PZ	1	57,00
006 100 095	D.2"1/2 1701 R.B.	pz	1	250,60
006 100 096	D.3" 1701 R.B.	PZ	1	366,20
006 100 097	D.4" 1701 R.B.	PZ	1	640,10



Valvola a Farfalla
Femmina Femmina

CODICE	MISURA	UM	PZ	€
006 100 008	D.1/2 1520 R.B.	PZ	10	6,30
006 100 009	D.3/4 1520 R.B.	PZ	10	10,90
006 100 010	D.1" 1520 R.B.	PZ	10	15,00



Valvola a Farfalla
Maschio Femmina

CODICE	MISURA	UM	PZ	€
006 100 018	D.1/2 1521 R.B.	PZ	10	7,10
006 100 019	D.3/4 1521 R.B.	PZ	10	11,20
006 100 020	D.1" 1521 R.B.	PZ	10	15,70



Valvola a Farfalla
Bocchettonata
Maschio Femmina

CODICE	MISURA	UM	PZ	€
006 100 011	D.1/2x1/2 4504 R.B.	PZ	10	13,10
006 100 012	D.3/4x3/4 4504 R.B.	PZ	10	14,30
006 100 013	D.1" x1" 4504 R.B.	PZ	10	23,40
006 100 014	D.1"1/4x1"1/4 4604 R.B.	PZ	10	43,00



Valvola Mignon
Maschio Femmina

CODICE	MISURA	UM	PZ	€
006 091 016	D.3/8	PZ	10	4,80
006 091 017	D.1/2	PZ	10	4,80



Valvola Mignon
Femmina Femmina

CODICE	MISURA	UM	PZ	€
006 091 015	D.3/8	PZ	10	4,50
006 091 018	D.1/2	PZ	10	4,80



Valvola Mignon
Maschio Femmina

CODICE	MISURA	UM	PZ	€
006 091 020	D.1/2	PZ	10	4,90



Valvola Mignon
Maschio Femmina Leva Nera

CODICE	MISURA	UM	PZ	€
006 091 021	D.1/2	PZ	10	4,90



CODICE	MISURA	UM	PZ	€
006 100 033	D.1/2 R.B.	PZ	10	21,10
006 100 034	D.3/4 R.B.	PZ	10	30,00
006 100 035	D.1" R.B.	PZ	10	44,70

Rubinetto Porta Gomma
con Regolazione di Flusso



CODICE	MISURA	UM	PZ	€
006 100 047	D.1/2 R.B.	PZ	10	8,80
006 100 048	D.3/4 R.B.	PZ	10	12,70
006 100 049	D.1" R.B.	PZ	10	21,90

Rubinetto Porta Gomma
Pesante



CODICE	MISURA	UM	PZ	€
006 165 011	D.1/2	PZ	10	7,50
006 165 012	D.3/4	PZ	10	10,70
006 165 013	D.1"	PZ	10	19,10

Rubinetto Porta Gomma
Normale



CODICE	MISURA	UM	PZ	€
006 165 070	D.1/2	PZ	10	8,90

Rubinetto Porta Gomma
Normale con Porta Lucchetto



CODICE	MISURA	UM	PZ	€
006 100 037	D.3/4 x15	PZ	10	1,40
006 100 043	D.1" x20	PZ	10	2,40
006 100 050	D.1"1/4x25	PZ	10	4,90

Raccordo Porta Gomma
Ottone per Rubinetto



CODICE	MISURA	UM	PZ	€
006 100 076	D.3/4x15	PZ	10	0,80
006 100 077	D.1" x20	PZ	10	1,10

Raccordo Porta Gomma
Nylon per Rubinetto



CODICE	MISURA	UM	PZ	€
006 100 036	D.1/2 R.B.	PZ	10	22,90
006 100 072	D.3/4	PZ	10	28,90

Rubinetto Incasso
con Cappuccio



CODICE	MISURA	UM	PZ	€
006 100 041	D.1/2	PZ	10	28,90
006 100 042	D.3/4	PZ	10	38,40

Rubinetto Incasso
Femmina Femmina a Leva



CODICE	MISURA	UM	PZ	€
006 100 073	D.16	PZ	10	55,60
006 100 074	D.20	PZ	10	53,90

Rubinetto Valvola Incasso
Attacchi a Pressare Cappuccio
Cromato Multistrato





Valvola a Squadro
Bocchettone
Maschio Femmina
a Leva Rossa

CODICE	MISURA	UM	PZ	€
006 100 139	D.1/2 R.B.	PZ	10	13,70
006 100 140	D.3/4 R.B.	PZ	10	17,80
006 100 141	D.1" R.B.	PZ	10	27,40



Valvola a Squadro
Bocchettone
Maschio Femmina
a Leva Blù

CODICE	MISURA	UM	PZ	€
006 100 136	D.1/2 R.B.	PZ	10	13,70
006 100 137	D.3/4 R.B.	PZ	10	17,80
006 100 138	D.1" R.B.	PZ	10	27,40



Valvola a 3 Vie
Deviatrice Manovra a T

CODICE	MISURA	UM	PZ	€
006 100 156	D.1/2 R.B.	PZ	10	85,10
006 100 155	D.3/4 R.B.	pz	10	126,60
006 100 039	D.1" R.B.	PZ	10	19,20



Valvola a 3 Vie
Deviatrice Manovra a L

CODICE	MISURA	UM	PZ	€
006 100 161	D.1/2 R.B.	PZ	10	85,10
006 100 160	D.3/4 R.B.	PZ	10	126,60
006 100 040	D.1" R.B.	PZ	10	191,20



Valvola 3 Vie
Deviatrice Manovra
Squadro T

CODICE	MISURA	UM	PZ	€
006 100 061	D.1" R.B.	PZ	10	90,00



Valvola 3 Vie
Deviatrice Manovra
Squadro L

CODICE	MISURA	UM	PZ	€
006 100 064	D.1" R.B.	PZ	10	90,00



Valvola Eurofly a Leva
Femmina Femmina

CODICE	MISURA	UM	PZ	€
006 100 120	D.1/2 R.B.	PZ	10	18,40
006 100 121	D.3/4 R.B.	PZ	10	22,50
006 100 122	D.1" R.B.	PZ	10	29,20
006 100 123	D.1"1/4 R.B.	PZ	10	46,10
006 100 124	D.1"1/2 R.B.	PZ	10	59,20
006 100 125	D.2" R.B.	PZ	10	79,20



Valvola Eurofly a Leva
Maschio Femmina

CODICE	MISURA	UM	PZ	€
006 100 127	D.1/2	PZ	10	19,50
006 100 128	D.3/4	PZ	10	25,00
006 100 129	D.1"	PZ	10	32,60
006 100 130	D.1"1/4	PZ	10	53,10
006 100 131	D.1"1/2	PZ	10	64,60
006 100 132	D.2"	PZ	10	93,40

CODICE	MISURA	UM	PZ	€
006 165 001	D.1/2	PZ	10	9,70
006 165 002	D.3/4	PZ	8	13,10
006 165 003	D.1"	PZ	6	17,90
006 165 024	D.1"1/4	PZ	1	28,10
006 165 025	D.1"1/2	PZ	1	37,60
006 165 045	D.2"	PZ	1	57,80

Valvola Ritegno
Europa
Itap



CODICE	MISURA	UM	PZ	€
006 165 005	D.1/2	PZ	10	9,40
006 165 006	D.3/4	PZ	10	12,80
006 165 007	D.1"	PZ	10	18,70
006 165 004	D.1"1/4	PZ	1	27,90
006 165 026	D.1"1/2	PZ	1	33,40
006 165 046	D.2"	PZ	1	50,40
006 165 075	D.3"	PZ	1	118,60

Valvola Ritegno Caplet
Sede Gomma
Itap



CODICE	MISURA	UM	PZ	€
006 165 044	D.3/4	PZ	10	10,90
006 165 014	D.1"	PZ	10	13,00
006 165 033	D.1"1/4	PZ	10	16,80
006 165 034	D.1"1/2	PZ	10	23,30
006 165 035	D.2"	PZ	10	34,30
006 165 037	D.3"	PZ	10	81,10

Valvola di Fondo
Itap



CODICE	MISURA	UM	PZ	€
006 165 038	D.1/2	PZ	10	1,50
006 165 039	D.3/4	PZ	10	1,70
006 165 008	D.1"	PZ	10	1,90
006 165 009	D.1"1/4	PZ	10	2,50
006 165 010	D.1"1/2	PZ	10	3,20
006 165 036	D.2"	PZ	10	4,00

Filtro Acciaio
per Valvola di Fondo
Itap



CODICE	MISURA	UM	PZ	€
006 100 100	D.1/2	PZ	10	10,40
006 100 101	D.3/4	PZ	10	14,00
006 100 102	D.1"	PZ	10	19,20
006 100 103	D.1"1/4	PZ	10	30,20
006 100 104	D.1"1/2	PZ	10	48,70

Valvola Ritegno
Euroblock R.B.



CODICE	MISURA	UM	PZ	€
006 100 106	D.1/2	PZ	10	15,00
006 100 107	D.3/4	PZ	10	15,00
006 100 108	D.1"	PZ	10	21,80
006 100 109	D.1"1/4	PZ	10	29,60
006 100 110	D.1"1/2	PZ	10	43,20
006 100 111	D.2"	PZ	10	61,40

Valvola Ritegno
Caplet R.B.



CODICE	MISURA	UM	PZ	€
006 100 118	D.1/2	PZ	10	210,90
006 100 119	D.3/4	PZ	10	212,30

Disconnettore Idraulico
Idroblock R.B.





SETTORE 006

IDRAULICA



Valvola Gas a Leva
Femmina Femmina
R.B.

CODICE	MISURA	UM	PZ	€
006 100 060	D.3/8	PZ	10	11,10
006 100 028	D.1/2	PZ	10	9,80
006 100 029	D.3/4	PZ	10	14,60
006 100 030	D.1"	PZ	10	20,10
006 100 031	D.1"1/4	PZ	1	35,10
006 100 032	D.1"1/2	PZ	1	49,20
006 100 150	D.2"	PZ	1	86,60
006 100 151	D.2"1/2	PZ	1	256,00
006 100 152	D.3"	PZ	1	374,00
006 100 153	D.4"	PZ	1	653,40



Valvola Gas a Leva
Maschio Femmina
R.B.

CODICE	MISURA	UM	PZ	€
006 100 066	D.1/2	PZ	10	10,60
006 100 067	D.3/4	PZ	10	15,20
006 100 068	D.1"	PZ	10	21,00
006 100 069	D.1"1/4	PZ	1	37,80
006 100 070	D.1"1/2	PZ	1	52,70
006 100 071	D.2"	PZ	1	82,00



Valvola Gas a Farfalla
Femmina Femmina
R.B.

CODICE	MISURA	UM	PZ	€
006 100 044	D.3/8	PZ	10	11,10
006 100 025	D.1/2	PZ	10	8,90
006 100 026	D.3/4	PZ	10	14,40
006 100 027	D.1"	PZ	10	18,10



Valvola Gas a Farfalla
Maschio Femmina
R.B.

CODICE	MISURA	UM	PZ	€
006 100 052	D.1/2	PZ	10	10,40
006 100 053	D.3/4	PZ	10	13,70
006 100 054	D.1"	PZ	10	18,90



Valvola Gas Squadro
a Farfalla Maschio Femmina
R.B.

CODICE	MISURA	UM	PZ	€
006 100 056	D.1/2x1/2	PZ	10	13,10



Valvola Gas Farfalla
con Portagomma Diritta
Maschio R.B.

CODICE	MISURA	UM	PZ	€
006 100 021	D.1/2x8 GPL	PZ	10	11,80
006 100 022	D.1/2x13 METANO	PZ	10	12,50



Valvola Gas Farfalla
con Portagomma Squadro
Maschio R.B.

CODICE	MISURA	UM	PZ	€
006 100 023	D.1/2x8 GPL	PZ	10	12,50
006 100 024	D.1/2x13 METANO	PZ	10	13,30



Valvola Gas Farfalla
con Girello Squadro
Maschio R.B.

CODICE	MISURA	UM	PZ	€
006 100 134	D.1/2x1/2	PZ	10	14,80
006 100 135	D.1/2x3/4	PZ	10	18,30
006 100 051	D.3/4x3/4	PZ	10	24,90



Valvola Gas Farfalla
con Girello Squadro
Femmina R.B.

CODICE	MISURA	UM	PZ	€
006 100 055	D.1/2	PZ	10	14,80



CODICE	MISURA	UM	PZ	€
019 100 076	D.14 Uni 7129 D.14	PZ	10	76,60

Scatola Valvola Gas
Ispezionabile da Incasso
R.B.



CODICE	MISURA	UM	PZ	€
006 100 057	D.1/2x1/2 - Cod. 9087	PZ	10	11,40

Valvola Gas Squadro
Maschio Maschio
R.B.



CODICE	MISURA	UM	PZ	€
006 100 175	D.3/4	PZ	1	20,60
006 100 176	D.1"	PZ	1	31,90

Valvola Gas Post Contatore
con Presa Pressione
Femmina Femmina R.B.



CODICE	MISURA	UM	PZ	€
006 100 178	D.3/4x1"	PZ	1	33,00
006 100 179	D.1" x1"	PZ	1	38,40

Valvola Gas Post Contatore
con Presa Press.Squadro
Femmina Maschio R.B.



CODICE	MISURA	UM	PZ	€
006 100 186	D.1"1/4x1"	PZ	1	15,70

Raccordo Valvola Gas Post
Contatore per Tubo Filettato
Maschio Femmina R.B.



CODICE	MISURA	UM	PZ	€
006 100 172	D.3/4x1"1/4	PZ	1	67,20
006 100 173	D.1" x1"1/4	PZ	1	75,70

Valvola Gas Post Contatore
con Presa Pressione
e Serratura Squadro
Maschio Femmina R.B.



CODICE	MISURA	UM	PZ	€
006 100 180	D.3/4x3/4	PZ	1	56,20
006 100 181	D.1" x1"	PZ	1	68,60

Valvola Gas Post Contatore
con Presa Pressione
e Serratura
Femmina Femmina R.B.



CODICE	MISURA	UM	PZ	€
006 100 075	D.1/2x1/2	PZ	10	10,50

Valvola Gas Squadro
a Farfalla Maschio Maschio
Itap



CODICE	MISURA	UM	PZ	€
006 165 056	D.1/2	PZ	10	9,20

Valvola Gas Maschio
Femmina a Farfalla
R.B.



CODICE	MISURA	UM	PZ	€
006 100 195	D.1/2 x 1/2	PZ	10	16,70
006 100 196	D.1/2 x 3/4	PZ	10	19,10

Valvola Gas Farfalla con
Girello Diritto
Femmina Maschio R.B.



CODICE	MISURA	UM	PZ	€
006 100 190		PZ	10	7,80

Valvola Presa
Pressione Gas
R.B.





Valvola Sfera Farfalla
Maschio Femmina

CODICE	MISURA	UM	PZ	€
006 165 021	D.1/2	PZ	10	6,00
006 165 022	D.3/4	PZ	10	8,80
006 165 023	D.1"	PZ	10	15,00



Valvola Sfera Farfalla
Femmina Femmina

CODICE	MISURA	UM	PZ	€
006 165 018	D.1/2	PZ	10	6,00
006 165 019	D.3/4	PZ	10	8,20
006 165 020	D.1"	PZ	10	13,90



Valvola Sfera Leva
Maschio Femmina

CODICE	MISURA	UM	PZ	€
006 165 030	D.1/2	PZ	10	6,00
006 165 031	D.3/4	PZ	10	8,80
006 165 032	D.1"	PZ	10	15,00



Valvola Sfera Leva
Femmina Femmina

CODICE	MISURA	UM	PZ	€
006 165 015	D.1/2	PZ	10	6,00
006 165 016	D.3/4	PZ	10	8,80
006 165 017	D.1"	PZ	10	15,00



Valvola Sfera a Farfalla
con Bocchettone
Maschio Femmina

CODICE	MISURA	UM	PZ	€
006 165 041	D.1/2	PZ	10	10,50
006 165 042	D.3/4	PZ	10	15,40
006 165 043	D.1"	PZ	10	24,70
006 165 051	D.1"1/4	PZ	10	25,00



Rubinetto Scarico Condensa
per Caldaia Con Portagomma
e Tappo

CODICE	MISURA	UM	PZ	€
006 165 090	D.1/2	PZ	10	6,60



Rubinetto Enologico Ottone
Cromato con Leva Nera

CODICE	MISURA	UM	PZ	€
006 165 072	D.1/2	PZ	10	9,60
006 165 073	D.3/8	PZ	10	8,50



Rubinetto Artistico Leone
in Ottone

CODICE	MISURA	UM	PZ	€
006 165 074	D.1/2	PZ	10	41,70



CODICE	MISURA	UM	PZ	€
007 124 001	D.1"1/4	PZ	10	14,60

Piletta per Piatto Doccia
Diritta Normale



CODICE	MISURA	UM	PZ	€
007 124 103	D.1"1/4	PZ	10	21,30

Piletta per Piatto Doccia
Diritta Pesante



CODICE	MISURA	UM	PZ	€
007 124 093	D.1"1/4	PZ	10	6,50

Griglia per Piletta Piatto
Doccia



CODICE	MISURA	UM	PZ	€
007 124 002	D.80x1"1/4	PZ	10	27,30

Pilettoni Sifoide Lavello
Con Tappo e Catenella



CODICE	MISURA	UM	PZ	€
007 124 102	D. 80 x 1"1/4	PZ	10	7,40

Piletta Gattinara in Ottone
per Lavello e Lavatoio
in Ceramica con Tappo
e Catenella



CODICE	MISURA	UM	PZ	€
007 124 084	D.1"1/4	PZ	10	22,70

Piletta Sifoide
Piatto Doccia
ad Incollaggio



CODICE	MISURA	UM	PZ	€
009 022 104	D.1"1/4x80	PZ	10	19,30

Piletta Sifoide Piatto Doccia
per Tubi ad Innesto Bonomini



CODICE	MISURA	UM	PZ	€
007 124 104	D.1"1/4x80	PZ	10	12,20

Piletta Sifoide Piatto Doccia
per Tubi ad Innesto Tea





Sifone per Piatto Doccia
con Piletta
Geberit

CODICE	MISURA	UM	PZ	€
007 078 001	D. 60 mm	PZ	10	62,40



Sifone per Piatto Doccia
con Piletta
Geberit

CODICE	MISURA	UM	PZ	€
007 078 005	D. 90 mm	PZ	10	100,80



Piletta Sifonata Liscia
per Tubi ad Innesto Ottone

CODICE	MISURA	UM	PZ	€
007 124 121	D. 1"1/4x80	PZ	10	25,60



Piletta Sifonata Filettata
per Tubi ad Innesto Ottone

CODICE	MISURA	UM	PZ	€
007 124 120	D. 1"1/4x80	PZ	10	30,10



Piletta Sifone Filettata
per Tubi ad Innesto Ottone

CODICE	MISURA	UM	PZ	€
007 124 117	D. 1"1/2x90 Tea	PZ	16	22,30



Piletta Sifoide Ribassata
Orientabile ad Innesto

CODICE	MISURA	UM	PZ	€
007 124 115	D. 1"1/2x80 40-50	PZ	10	13,70



Piletta Sifoide Ribassata
Orientabile Incollaggio
con Ghiera

CODICE	MISURA	UM	PZ	€
007 124 116	D. 1"1/2x80 40-50	PZ	10	12,70



Raccoro Curvo in PP
con Dado in Ottone

CODICE	MISURA	UM	PZ	€
009 022 071	1" 1/4 x 40	PZ	5	5,40
009 022 072	1" 1/2 x 40	PZ	5	5,40



Raccordo Diritto in PP
con Dado in Ottone

CODICE	MISURA	UM	PZ	€
009 022 105	D. 1"1/4x40	PZ	5	5,20
009 022 106	D. 1"1/2x40	PZ	5	5,20



CODICE	MISURA	UM	PZ	€
007 124 118	D.1"1/4x63	PZ	10	33,80

Piletta Clicker per Lavabo in Ceramica Con Troppo Pieno Ottone



CODICE	MISURA	UM	PZ	€
007 124 119	D.1"1/4x63	PZ	10	33,80
007 124 122	D.1"1/4x63	PZ	10	33,80

Piletta Clicker per Lavabo in Ceramica Senza Troppo Pieno Ottone



CODICE	MISURA	UM	PZ	€
007 124 003	D.1"	PZ	10	13,50
007 124 014	D.1"1/4	PZ	10	14,40

Pilettoni per Lavabo con Troppo Pieno



CODICE	MISURA	UM	PZ	€
007 124 044	D.1"	PZ	10	13,50
007 124 052	D.1"1/4	PZ	10	14,40

Pilettoni per Lavabo Senza Troppo Pieno



CODICE	MISURA	UM	PZ	€
007 124 022	D.1"	PZ	10	23,40
007 124 053	D.1"1/4	PZ	10	23,40

Piletta Scarico Automatico con Salterello Ottone Pesante



CODICE	MISURA	UM	PZ	€
007 124 087	D.1" Leggero	PZ	10	3,90
007 124 095	D.1"1/4 Ottone	PZ	10	7,90

Tappo Piletta Salterello



CODICE	MISURA	UM	PZ	€
007 124 050	Kit morsetto e due aste	PZ	10	2,40

Kit Asta e Morsetto Comando per Piletta e Salterello





SETTORE 007
IDRAULICA



Tappi di Riparazione
Tapparello Lavabo e Bidet

CODICE	MISURA	UM	PZ	€
001 132 010	D.30x1"	PZ	10	25,20
001 132 011	D.38x1"1/4	PZ	10	25,20
001 132 012	D.30-38x1" e 1"1/4	PZ	10	25,40



Tappi di Riparazione
Tappaguasti Colonna Vasca

CODICE	MISURA	UM	PZ	€
001 132 013	D.74	PZ	10	28,00



Tappi di Riparazione
Tappatutto Lavello Cucina

CODICE	MISURA	UM	PZ	€
001 132 014	D.84	PZ	10	18,40
001 132 015	D.64	PZ	10	25,40



Cestello per Pilettone
Lavatoio Ottone

CODICE	MISURA	UM	PZ	€
007 124 062		PZ	10	6,50



Cestello per Pilettone
Lavatoio Plastica

CODICE	MISURA	UM	PZ	€
007 124 092		PZ	10	0,70



Tappo Piletta
con Catenella

CODICE	MISURA	UM	PZ	€
007 124 057	D.27	PZ	10	2,00
007 124 058	D.31	PZ	10	2,00
007 124 059	D.40	PZ	10	2,10



Tappo Piletta
con Anello Plastica

CODICE	MISURA	UM	PZ	€
007 124 060	D.47	PZ	10	1,20
007 124 061	D.52	PZ	10	1,10

CODICE	MISURA	UM	PZ	€
007 124 004	D.1" Tubo D.26x19 Cm	PZ	10	20,30
007 124 005	D.1"1/4 Tubo D.32x19 Cm	PZ	10	22,60
007 124 085	D.1" Tubo D.26x25 Cm	PZ	10	18,50
007 124 086	D.1"1/4 Tubo D.32x25 Cm	PZ	10	21,40

Sifone a S con Rosone
Ottone Cromato



CODICE	MISURA	UM	PZ	€
007 124 025	D.1" Tubo D.26x19 Cm	PZ	10	18,70
007 124 026	D.1"1/4 Tubo D.32x19 Cm	PZ	10	23,90
007 124 088	D.1" Tubo D.26x25 Cm	PZ	10	18,50
007 124 089	D.1"1/4 Tubo D.32x25 Cm	PZ	10	21,40

Sifone a Bottiglia
con Rosone Ottone Cromato



CODICE	MISURA	UM	PZ	€
007 124 090	D.1"1/4 Tubo D.32 Tea	PZ	10	55,80

Sifone D'arredo Maomao
con Rosone Ottone Cromato



CODICE	MISURA	UM	PZ	€
007 124 123	D.1" Tubo D.26x25 Cm	PZ	10	19,90
007 124 124	D.1"1/4 Tubo D.32x25 Cm	PZ	10	18,70

Sifone a S con Rosone
ABS Cromato



CODICE	MISURA	UM	PZ	€
007 124 125	D.1" Tubo D.26x25Cm	PZ	10	21,30
007 124 126	D.1"1/4 Tubo D.32x25Cm	PZ	10	18,70

Sifone a Bottiglia
con Rosone ABS Cromato



CODICE	MISURA	UM	PZ	€
007 124 165	D.1"1/4x40	PZ	10	19,40

Sifone per Lavabo Disabili
Basculante





Canotto Bianco
Allacciamento Cassetta
Incasso Geberit

CODICE	MISURA	UM	PZ	€
009 078 030		PZ	1	34,90

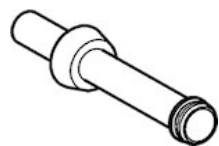

Canotto Cromato
Cassetta Dual Flusc

CODICE	MISURA	UM	PZ	€
009 077 043	37102000 Ghohe	PZ	1	118,70



Canotto Diritto
Ottone Cromato

CODICE	MISURA	UM	PZ	€
007 124 008	D.26x300	PZ	10	3,50
007 124 006	D.30x300	PZ	10	3,70
007 124 007	D.32x300	PZ	10	4,00
007 124 082	D.40x300	PZ	10	5,40



Canotto Diritto
con Orlo Ottone Cromato

CODICE	MISURA	UM	PZ	€
007 124 009	D.26x250	PZ	10	3,20
007 124 080	D.26x300	PZ	10	3,80
007 124 011	D.30x300	PZ	10	3,90
007 124 010	D.32x300	PZ	10	4,20
007 124 130	D.40x300	PZ	10	5,60



Canotto Curvo
a 45° Ottone Cromato

CODICE	MISURA	UM	PZ	€
007 124 054	D.30x250x250	PZ	10	13,00
007 124 012	D.30x160x160	PZ	10	6,60



Canotto Curvo a 90°
Ottone Cromato

CODICE	MISURA	UM	PZ	€
007 124 013	D.30	PZ	10	7,80



Canotto Flessibile
Ottone Cromato

CODICE	MISURA	UM	PZ	€
007 124 024	D.26x300	PZ	10	6,40
007 124 051	D.30x300	PZ	10	7,20
007 124 023	D.32x300	PZ	10	7,40



Canotto Prolunga
Ottone Cromato

CODICE	MISURA	UM	PZ	€
007 124 029	D.26x130	PZ	10	3,90
007 124 030	D.30x130	PZ	10	4,30
007 124 031	D.32x130	PZ	10	4,60



Canotto Manicotto
Ottone Cromato

CODICE	MISURA	UM	PZ	€
007 124 131	D.26x60	PZ	10	5,20
007 124 132	D.30x60	PZ	10	5,30
007 124 133	D.32x60	PZ	10	5,50
007 124 134	D.40x60	PZ	10	6,00



CODICE	MISURA	UM	PZ	€
007 124 205	D.32x26	PZ	10	4,70
007 124 206	D.40x32	PZ	10	5,70

Canotto Manicotto Ridotto
Ottone Cromato



CODICE	MISURA	UM	PZ	€
007 124 055	D.26x300	PZ	10	10,00
007 124 056	D.30x300	PZ	10	8,70
007 124 040	D.32x300	PZ	10	9,00
007 124 177	D.40x300	PZ	10	11,10

Canotto Eccentrico
Ottone Cromato



CODICE	MISURA	UM	PZ	€
007 124 175	D.32x50	PZ	10	19,80

Canotto Airpipe con Valvola
Ottone Cromato

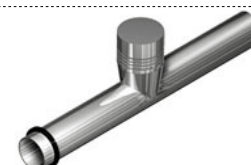

CODICE	MISURA	UM	PZ	€
007 124 178	D.10x40	PZ	10	11,40

Rosone Eccentrico Cassetta
Incasso Bianco



CODICE	MISURA	UM	PZ	€
007 124 138	D.32x26	PZ	10	5,00
007 124 139	D.40x32	PZ	10	5,30

Canotto Riduzione Piombo
Ottone Cromato



CODICE	MISURA	UM	PZ	€
007 124 019	D.26	PZ	25	1,10
007 124 017	D.30	PZ	25	0,60
007 124 018	D.32	PZ	25	0,60
007 124 145	D.40	PZ	25	0,60

Rosone per Canotto
Acciaio Cromato



CODICE	MISURA	UM	PZ	€
007 124 083	D.32	PZ	25	7,30
007 124 079	D.30	PZ	25	7,30

Rosone per Canotto
Cromato



CODICE	MISURA	UM	PZ	€
007 124 021	D.75	PZ	25	2,20

Rosone Ovale per Canotto
Acciaio Cromato



CODICE	MISURA	UM	PZ	€
007 124 045	D.110	PZ	10	6,50

Rosone Ovale Maggiorato per
Canotto Acciaio Cromato



CODICE	MISURA	UM	PZ	€
007 124 016	D.1"1/4	PZ	10	2,50
007 124 015	D.1"1/2	PZ	10	2,50

Dado Ottone Giallo
per Raccordi in PP
e Canotto C/Cartella



CODICE	MISURA	UM	PZ	€
007 124 027	D.1"x26	PZ	10	1,60
007 124 028	D.1"1/4x30	PZ	10	2,10
007 124 200	D.1"1/4x32	PZ	10	2,10

Dado Ottone Cromato
per Raccordi in PP D.1"1/4
e Canotto Ccon Cartella





SETTORE 007

IDRAULICA



Sifone Lavello 1 Via
Senza Piletta

CODICE	MISURA	UM	PZ	€
007 124 035	D.1"1/4	PZ	10	5,10
007 124 038	D.1"1/2	PZ	10	5,40



Sifone Lavello 1 Via
con Piletta

CODICE	MISURA	UM	PZ	€
007 124 032	D.1"1/4	PZ	10	9,80
007 124 099	D.1"1/2	PZ	10	12,00



Sifone Lavello Salvaspazio
1 Via Senza Piletta

CODICE	MISURA	UM	PZ	€
007 124 155	D.1"1/4x40	PZ	10	14,50



Sifone Lavello 2 Vie
Senza Piletta

CODICE	MISURA	UM	PZ	€
007 124 046	D.1"1/4	PZ	10	6,70
007 124 037	D.1"1/2	PZ	10	7,40



Sifone Lavello Salvaspazio
2 Vie Senza Piletta

CODICE	MISURA	UM	PZ	€
007 124 156	D.1"1/2x40	PZ	10	21,20



Sifone Lavello 2 Vie
con Piletta

CODICE	MISURA	UM	PZ	€
007 124 047	D.1"1/4	PZ	10	16,30
007 124 063	D.1"1/2	PZ	10	20,40



Sifone Lavello 1 Via
con Piletta e Troppo Pieno

CODICE	MISURA	UM	PZ	€
007 124 065	D.1"1/2	PZ	10	14,10



Piletta Lavello
con Troppo Pieno

CODICE	MISURA	UM	PZ	€
007 124 049	D.1"1/2	PZ	10	8,60



Sifone Lavello 2 Vie
con Piletta e Troppo Pieno

CODICE	MISURA	UM	PZ	€
007 124 070	D.1"1/2	PZ	10	22,50



Piletta Lavello
Senza Troppo Pieno

CODICE	MISURA	UM	PZ	€
007 124 048	D.1"1/4	PZ	10	4,80
007 124 071	D.1"1/2	PZ	10	5,10



Piletta Lavello
Senza Troppo Pieno

CODICE	MISURA	UM	PZ	€
007 124 150	D.1"1/2x115 D.90	PZ	10	13,20



CODICE	MISURA	UM	PZ	€
007 124 151	D.1"1/2x115 D.90	PZ	10	16,10

Piletta Lavello
con Troppo Pieno



CODICE	MISURA	UM	PZ	€
007 124 096	D.1"1/4x32	PZ	10	4,90
007 124 097	D.1"1/2x40	PZ	10	4,30

Tubo Lavello
Attacco lavatrice



CODICE	MISURA	UM	PZ	€
007 124 147	D.1"1/4x32x200	PZ	10	2,70
007 124 148	D.1"1/2x40x200	PZ	10	3,20

Tubo Lavello
Prolunga Attacco Lavatrice



CODICE	MISURA	UM	PZ	€
007 124 078	D.1"1/4Mx 1"F	PZ	25	0,70
007 124 039	D.1"1/2Mx1"1/4F	PZ	25	0,80

Riduzione Moplen
Maschio Femmina



CODICE	MISURA	UM	PZ	€
007 124 100	D.1"1/4Fx 1"M	PZ	25	0,70
007 124 077	D.1"1/2Fx1"1/4M	PZ	25	0,70

Riduzione Moplen
Femmina Maschio



CODICE	MISURA	UM	PZ	€
007 124 135	D.1" Bianco	PZ	10	0,90
007 124 136	D.1" Cromato	PZ	10	2,30

Raccordo Attacco
Portagomma Lavatrice



CODICE	MISURA	UM	PZ	€
007 124 180	D. 26x26	PZ	10	5,30
007 124 181	D. 32x32	PZ	10	5,30
007 124 182	D. 40x40	PZ	10	5,30

Passepartout Connessione
Femmina Femmina PP Bianco



CODICE	MISURA	UM	PZ	€
007 124 185	D. 32x26	PZ	10	5,30
007 124 186	D. 40x32	PZ	10	5,30
007 124 187	D. 50x40	PZ	10	5,30

Passepartout Connessione
Ridotto Femmina Femmina
PP Bianco



CODICE	MISURA	UM	PZ	€
007 124 190	D.40x1"1/4mm	PZ	10	5,30
007 124 191	D.50x1"1/2mm	PZ	10	5,30

Passepartout Connessione
Flangiato Aumento Femmina
PP Bianco



CODICE	MISURA	UM	PZ	€
007 124 195	D.26x1"1/4mm	PZ	10	5,30
007 124 196	D.32x1"1/2mm	PZ	10	5,30

Passepartout Connessione
Flangiato Riduzione Femmina
PP Bianco



CODICE	MISURA	UM	PZ	€
007 124 198	D.26M.x 32F.mm	PZ	10	5,30
007 124 199	D.32M.x 40F.mm	PZ	10	5,30

Passepartout Connessione
Aumento Maschio Femmina
PP Bianco





SETTORE 007

IDRAULICA



Sifone HL Salvaspazio
Attacco Lavatrice Antiriflusso
Lavello 1 Via

CODICE	MISURA	UM	PZ	€
007 011 004	D.40 - HL 126/40	PZ	1	33,90



Sifone HL Salvaspazio
Attacco Lavatrice Antiriflusso
Lavello 2 Vie

CODICE	MISURA	UM	PZ	€
007 011 003	D.40 - HL 126 2/40	PZ	1	51,60



Canotto HL con Attacco
Lavatrice Antiriflusso Lavello

CODICE	MISURA	UM	PZ	€
007 011 005	D.1"1/2x40 - HL 13/40	PZ	1	11,20



Canotto HL con Attacco
Lavatrice Antiriflusso Lavello

CODICE	MISURA	UM	PZ	€
007 011 008	D.1"1/2x40 - HL 13-2/40	PZ	1	16,80



Attacco Doppio Lavatrice
Antiriflusso Portagomma
HL

CODICE	MISURA	UM	PZ	€
007 011 020	D.1" - HL 2	PZ	1	25,70



Sifone per Lavatrice
Incasso HL

CODICE	MISURA	UM	PZ	€
007 011 040	D.40/50 - HL 400	PZ	1	23,20



Sifone completo incasso
Doppio Sifonato
HL

CODICE	MISURA	UM	PZ	€
007 011 038	Adatta 4000.0 - HL 4000.3	PZ	1	32,00



Sifone per Lavatrice Incasso
HL Corpo

CODICE	MISURA	UM	PZ	€
007 011 041	DN 50/50 - HL 4000.0	PZ	1	21,70



Sifone per Lavatrice Incasso
HL Doppio Sifonato

CODICE	MISURA	UM	PZ	€
007 011 042	Adatta 4000.0 - HL 4000.1	PZ	1	33,30
007 011 043	Adatta 4000.0 - HL 4000.2	PZ	1	51,90



CODICE	MISURA	UM	PZ	€
007 011 016	D.40/50 -HL 138	PZ	1	52,00

Sifone Climatizzatore HL
da Incasso Scarico Condensa



CODICE	MISURA	UM	PZ	€
007 011 001	D.1"1/4x1"1/2 - HL 12.1	PZ	1	2,60
007 011 002	D.1"1/2x1"1/4 - HL 12.3	PZ	1	2,60

Riduzione e Distanziatore HL



CODICE	MISURA	UM	PZ	€
007 011 006	DN 32 - HL 130/30	PZ	1	36,40
007 011 007	DN 40 - HL 130/40	PZ	1	28,40

Sifone Orinatoio HL
Eccentrico

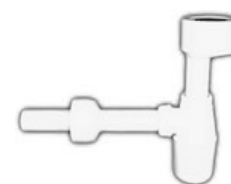

CODICE	MISURA	UM	PZ	€
007 011 045	DN40 - HL 430/40	PZ	1	37,90

Sifone Orinatoio HL
Orientabile Snodabile



CODICE	MISURA	UM	PZ	€
007 011 009	DN 32x5/4" - HL 132/30	PZ	1	18,90

Sifone a Bottiglia HL
per Lavabo con Rosone

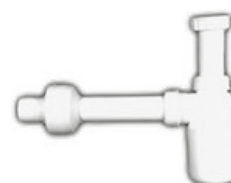

CODICE	MISURA	UM	PZ	€
007 011 010	DN 32x5/4" - HL 130/30	PZ	1	25,00

Sifone a Bottiglia HL
per Lavabo Con Rosone
Lavatrice



CODICE	MISURA	UM	PZ	€
007 011 011	DN 32x5/4" - HL 135/30	PZ	1	20,20

Sifone a Bottiglia HL
Lavabo e Bidet Con Rosone



CODICE	MISURA	UM	PZ	€
007 011 012	D.32x5/4" - HL 137/30	PZ	1	31,90
007 011 013	D.40x5/4" - HL 137/40	PZ	1	31,90

Sifone Salvaspazio HL
Lavabo Incasso
Con Deflusso Orizzontale





SETTORE 007

IDRAULICA



Manicotto di Allacciamento
Wc HL Eccentrico

CODICE	MISURA	UM	PZ	€
007 011 021	DN 110 - HL 200/1	PZ	1	14,80



Manicotto di Allacciamento
Wc HL Diritto

CODICE	MISURA	UM	PZ	€
007 011 022	DN 90 - HL 203/90 WE	PZ	1	20,10



Gomito di Allacciamento
Wc HL con Antiriflusso

CODICE	MISURA	UM	PZ	€
007 011 034	DN 110 - HL 703	PZ	1	286,50



Manicotto di Allacciamento
Wc HL Eccentrico Prolungato

CODICE	MISURA	UM	PZ	€
007 011 023	DN 110 - HL 204	PZ	1	23,20



Gomito di Allacciamento
Wc HL con Guarnizione
Labbrata

CODICE	MISURA	UM	PZ	€
007 011 024	DN 90 - HL 205	PZ	1	16,10



Attacco Wc HL
Scarico Sospeso Completo

CODICE	MISURA	UM	PZ	€
007 011 025	DN 110 - HL 221/1	PZ	1	28,40
007 011 026	DN 90 - HL 222/90	PZ	1	28,40



Dadi con Calotte HL
per Staffe Sanitari Sospesi

CODICE	MISURA	UM	PZ	€
007 011 100	HL 0222.2E	PZ	1	8,90



Curva Wc HL Accorciabile
con Morsetto+Staffe

CODICE	MISURA	UM	PZ	€
007 011 027	DN 110 - HL 124.1	PZ	1	65,50



Curva Wc HL Accorciabile
con Morsetto+Staffe

CODICE	MISURA	UM	PZ	€
007 011 029	DN 90 - HL 22590	PZ	1	28,00



Guarnizione Curva Wc HL

CODICE	MISURA	UM	PZ	€
007 011 019	DN 90 - HL 0225.2E	PZ	1	8,80



Sifone Piletta Doccia HL
Snodo

CODICE	MISURA	UM	PZ	€
007 011 064	DN40/50x90 - HL 520F	PZ	1	



CODICE	MISURA	UM	PZ	€
007 011 052	DN 40-50 - HL 514/SN-80	PZ	1	29,40

Sifone Piletta Doccia HL
Snodo Orizzontale carico



CODICE	MISURA	UM	PZ	€
007 011 053	DN40/50x90 - HL 522	PZ	1	72,80
007 011 054	DN40/50x90 - HL 522V	PZ	1	94,80

Sifone Piletta Doccia HL
D.90 Snodo Deflusso
Orizzontale o Verticale



CODICE	MISURA	UM	PZ	€
007 011 050	DN40/50x6/4" - HL 500-6/4	PZ	1	18,30

Sifone per Vasca HL
Snodo Deflusso



CODICE	MISURA	UM	PZ	€
007 011 044	HL 531	PZ	1	576,90

Canalina per Doccia HL
Filo Pavimento Completa
di Supporti



CODICE	MISURA	UM	PZ	€
007 011 046	DN 50 - HL 50F.080	PZ	1	868,10
007 011 047	DN 50 - HL 50F.090	PZ	1	892,50

Grondaia per Doccia HL
a Pavimento Completa di KiT



CODICE	MISURA	UM	PZ	€
007 011 048	HL 050S/80	PZ	1	57,40
007 011 049	HL 050S/90	PZ	1	64,50

Copertura Acciaio Inox HL
per Gronda Doccia



CODICE	MISURA	UM	PZ	€
007 011 033	H 80mm - HL 540	PZ	1	260,20

Pozzetto Doccia Pavimento
HL Primus Drain



CODICE	MISURA	UM	PZ	€
007 011 059	DN 40/50 123x123 - HL 510NPR	PZ	1	60,10

Pozzetto Doccia Pavimento
HL Scarico Orizzontale
con Flangia



CODICE	MISURA	UM	PZ	€
007 011 058	147x147 DN 50/40 - HL 510N	PZ	1	44,30

Pozzetto Doccia Pavimento
HL Flangiata





Pozzetto Doccia Pavimento
HL Deflusso Snodato

CODICE	MISURA	UM	PZ	€
007 011 081	123x115 DN 50/75 - HL 80.1	PZ	1	61,60



Pozzetto Doccia Pavimento
HL Foglio Bitumato

CODICE	MISURA	UM	PZ	€
007 011 082	123x115 DN 40/50 - HL 80.1H	PZ	1	162,10



Pozzetto Doccia Pavimento
HL Con Sifone Antiflusso

CODICE	MISURA	UM	PZ	€
007 011 030	123x123 DN 50 - HL 300	PZ	1	49,20



Pozzetto Doccia Pavimento
HL Scarico Verticale

CODICE	MISURA	UM	PZ	€
007 011 031	147x138 DN 50/75/110 - HL317H	PZ	1	200,80



Pozzetto Doccia Pavimento
HL Scarico Orizzontale
C/Flangia

CODICE	MISURA	UM	PZ	€
007 011 097	123x123 DN 40 - HL 90PRD	PZ	1	113,40



Pozzetto Doccia Pavimento
HL Scarico Orizzontale

CODICE	MISURA	UM	PZ	€
007 011 095	123x123 DN 40/50 - HL 90PR	PZ	1	73,20



Colonna Vasca Automatica
HL con Presa e Sifone
d'Acqua

CODICE	MISURA	UM	PZ	€
007 011 056	DN 40/50 - HL 555NLO	PZ	1	116,40



Maniglia Cromata Colonna
Vasca HL

CODICE	MISURA	UM	PZ	€
007 011 055	HL 55N.1	PZ	1	40,20



Colonna Vasca Automatica
HL Con Presa Ergonomica
Sifone d'Acqua

CODICE	MISURA	UM	PZ	€
007 011 057	DN 40/50 - HL 560N	PZ	1	225,60



CODICE	MISURA	UM	PZ	€
007 011 083	DN50/75 - HL 80H	PZ	1	162,10

Pozzetto per Terrazzo e Balcone Con Foglio Bituminato HL

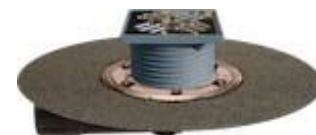

CODICE	MISURA	UM	PZ	€
007 011 084	400x400 - HL 83	PZ	1	61,00

Guarnizione per Impermeabilizzazione in EPDM HL



CODICE	MISURA	UM	PZ	€
007 011 090	100x100 DN 40/50 - HL 90.2	PZ	1	58,20
007 011 096	121x121 DN 40/50 HL 9 OPR - 3000	PZ	1	101,70

Pozzetto per Terrazzo e Balcone Con Flangia Isolante HL



CODICE	MISURA	UM	PZ	€
007 011 080	123x115 DN 50/75 - HL 80	PZ	1	51,60

Pozzetto per Terrazzo e Balcone HL



CODICE	MISURA	UM	PZ	€
007 011 076	100x100 DN 75/110 HL 72.1 HN	PZ	1	211,60

Pozzetto Sifonato per Cantina Con Manicotto Bituminato



CODICE	MISURA	UM	PZ	€
007 011 060	DN 75-110 - HL 600	PZ	1	149,30

Scarico Gronda Ispezionabile Snodabile Raccogli Foglie



CODICE	MISURA	UM	PZ	€
007 011 062	Cm 5 - HL 601	PZ	1	63,20

Prolunga per HL600 PP HL



CODICE	MISURA	UM	PZ	€
007 011 063	DN 110/125 - HL 602	PZ	1	55,30

Scarico Gronda Verticale Raccolta Foglie HL





SETTORE 007

IDRAULICA



Prolunga Portagriglia HL
per Grondaia

CODICE	MISURA	UM	PZ	€
007 011 061	MM 240X240 DN 195 - HL 608	PZ	1	64,50



Aeratore Incasso HL
Doppio Corpo Colonne
Ispezionabile

CODICE	MISURA	UM	PZ	€
007 011 098	DN 50/75 - HL 905	PZ	2	



Aeratore Doppio Corpo HL
per Colonne Scarico

CODICE	MISURA	UM	PZ	€
007 011 091	DN 50/75/110 - HL 900N	PZ	1	64,60



Aeratore con Raccordo T HL
Attacco 1''

CODICE	MISURA	UM	PZ	€
007 011 092	DN 32x5/4'' - HL 902T/30	PZ	1	34,50
007 011 093	DN32X6/4'' - HL 902T/40	PZ	1	34,50



Aeratore con Adattatore HL
per Allacciamenti

CODICE	MISURA	UM	PZ	€
007 011 094	DN 32/40/50 - HL 904	PZ	1	29,00



Valvola Antiriflusso HL
con Battente Acciaio Inox

CODICE	MISURA	UM	PZ	€
007 011 070	DN 110 - HL 710	PZ	1	288,80
007 011 071	DN 125 - HL 712	PZ	1	341,30
007 011 072	DN 160 - HL 715	PZ	1	386,50
007 011 073	DN 200 - HL 720	PZ	1	567,80



Valvola Antiriflusso HL
con Battente Acciaio Inox
Con Sportello Manuale
Valvola Caplet 1

CODICE	MISURA	UM	PZ	€
007 011 074	DN 110 - HL710.1	PZ	1	468,00



Valvola Antiriflusso HL
con Battente Acciaio Inox
Con Sportello Manuale
Valvola Caplet 2

CODICE	MISURA	UM	PZ	€
007 011 075	DN 110 - HL710.2	PZ	1	660,50



CODICE	MISURA	UM	PZ	€
007 135 001	Cm 47,5	PZ	1	51,70

Colonna Vasca Automatica
Tipo Standard in PP



CODICE	MISURA	UM	PZ	€
007 135 025	Cm 47,5	PZ	1	84,10

Colonna Vasca Automatica
Ottone Bronzata



CODICE	MISURA	UM	PZ	€
007 135 002	Cm 47,5	PZ	1	31,80

Colonna Vasca Automatica
con Cliker in PP



CODICE	MISURA	UM	PZ	€
007 135 003	Cm 47,5	PZ	1	79,60

Colonna Vasca Automatica
Ottone Cromata



CODICE	MISURA	UM	PZ	€
007 135 022	Cm 60	PZ	1	87,20

Colonna Vasca Automatica
a Sedere Tipo in PP



CODICE	MISURA	UM	PZ	€
007 135 014	Cm 90	PZ	1	53,90

Colonna Vasca Automatica
Tipo Standart in Ottone
Cromato



CODICE	MISURA	UM	PZ	€
007 135 023	Cm 47,5	PZ	1	156,50

Colonna Vasca Automatica
con Erogazione in Ottone
Cromato





SETTORE 007

IDRAULICA



Colonna Vasca Automatica con Drenaggio

CODICE	MISURA	UM	PZ	€
007 135 024	Cm 57,5 - PPL	PZ	1	89,80
007 135 026	Cm 57,5 - Ottone Bronzato	PZ	1	115,40



Colonna Vasca Automatica con Erogazione e Drenaggio in PPL

CODICE	MISURA	UM	PZ	€
007 135 027	Cm 57,5	PZ	1	203,30



Maniglia Colonna Vasca Ottone Cromata

CODICE	MISURA	UM	PZ	€
007 135 005		PZ	1	15,70



Piletta Colonna Vasca Cromata

CODICE	MISURA	UM	PZ	€
007 135 006	D.1/2	PZ	1	7,70



Tappo Piletta Colonna Vasca Cromata

CODICE	MISURA	UM	PZ	€
007 135 007	D.1"1/2	PZ	1	9,80



Sifone S per Vasca con Ghiera per Tubi PP

CODICE	MISURA	UM	PZ	€
009 070 128	D.1"1/2x40	PZ	10	8,10
009 070 046	D.1"1/2x50	PZ	10	6,40



Sifone S Ribassato Scarico Vasca con Ghiera

CODICE	MISURA	UM	PZ	€
009 070 205	D.1"1/4x40 - Ottone	PZ	10	10,10
009 070 206	D.1"1/2x40-50 - Ottone	PZ	10	11,30
009 070 204	D.1"1/2x40 - PP	PZ	10	5,10



CODICE	MISURA	UM	PZ	€
008 030 001	380x440x750 mm Kg 120	PZ	10	20,80
008 030 002	400x440x750 mm Kg 150	PZ	10	25,00
008 030 005	400x480x800 mm Kg 250 Magg.	PZ	10	26,80

Coppia Staffe Mensola per Clima



CODICE	MISURA	UM	PZ	€
008 030 010	Vaso e Bidet Universale	PZ	10	21,60
008 030 011	Staffa Bidet Pesante	PZ	10	66,50
008 030 012	Staffa Vaso Pesante	PZ	10	66,50

Coppia Staffe Fissaggio Sanitari Sospesi Bidet/Wc



CODICE	MISURA	UM	PZ	€
008 030 014	Per Wc e Bidet Sospesi	PZ	10	15,60

Protezione Universale Sanitari Sospesi Wc/Bidet



CODICE	MISURA	UM	PZ	€
008 030 021	D.3/8	PZ	100	0,90
008 030 022	D.1/2	PZ	100	0,90
008 030 023	D.3/4	PZ	100	0,90
008 030 087	D.1"	PZ	100	0,90
008 030 088	D.1"1/4	PZ	100	1,00
008 030 090	D.1"1/2	PZ	100	1,10
008 030 091	D.2"	PZ	100	1,10
008 030 092	D.2"1/2	PZ	100	1,80
008 030 093	D.3"	PZ	100	1,80
008 030 094	D.4"	PZ	100	1,80

Collare Fermatubo Pesante Completo di Tassello



CODICE	MISURA	UM	PZ	€
008 030 024	D.12	PZ	100	0,40
008 030 025	D.14	PZ	100	0,50
008 030 026	D.16	PZ	100	0,60
008 030 027	D.18	PZ	100	0,50
008 030 032	D.20	PZ	100	0,60
008 030 028	D.22	PZ	100	0,90
008 030 029	D.25	PZ	100	1,00
008 030 030	D.28	PZ	100	1,10
008 030 031	D.32	PZ	100	1,20

Collare Fermatubo in Nylon Completo



CODICE	MISURA	UM	PZ	€
008 030 059	D.10	PZ	100	0,20
008 030 060	D.12	PZ	100	0,20
008 030 061	D.14	PZ	100	0,20
008 030 063	D.16-18 3/8	PZ	100	0,20
008 030 064	D.22-1/2	PZ	100	0,30
008 030 066	D.27-3/4	PZ	100	0,40
008 030 065	D.32-1"	PZ	100	0,30
008 030 067	D.40-1"1/4	PZ	100	0,30
008 030 068	D.48-1"1/2	PZ	100	0,40
008 030 069	D.60-2"	PZ	100	0,40

Staffa Fermatubo Graffetta



CODICE	MISURA	UM	PZ	€
008 057 029	D.60	PZ	100	1,00
008 057 013	D.80	PZ	100	1,20
008 057 012	D.100	PZ	100	1,30
008 057 030	D.110	PZ	100	1,30
008 057 014	D.125	PZ	100	1,30

Collare Fermatubo per Tubi Pluviali Leggero Zincato





Collare Fermatubo per Tubi Pluviali Leggero Marrone

CODICE	MISURA	UM	PZ	€
008 057 022	D.80	PZ	100	1,50



Collare Fermatubo per Tubi Pluviali Quadro Marrone

CODICE	MISURA	UM	PZ	€
008 057 015	D.80x80	PZ	100	0,90
008 057 023	D.100x100	PZ	100	1,30



Collare Fermatubo Pesante per Tubo Polietilene

CODICE	MISURA	UM	PZ	€
008 057 021	D.40	PZ	100	2,50
008 057 025	D.50	PZ	100	2,60
008 057 034	D.63	PZ	100	2,70
008 057 035	D.75	PZ	100	2,90
008 057 039	D.80	PZ	100	3,10
008 057 040	D.90	PZ	100	2,90
008 057 026	D.100	PZ	100	3,30
008 057 036	D.110	PZ	100	3,40
008 057 019	D.140	PZ	100	4,20
008 057 037	D.160	PZ	100	4,50
008 057 038	D.200	PZ	100	5,20



Collare Fermatubo Tropicalizzato

CODICE	MISURA	UM	PZ	€
008 099 069	D.12	PZ	100	0,80
008 099 070	D.14	PZ	100	0,50
008 099 071	D.16	PZ	100	0,60
008 099 073	D.18	PZ	100	0,60
008 099 072	D.20	PZ	100	0,60
008 099 075	D.22	PZ	100	0,60
008 099 079	D.24	PZ	100	0,60
008 099 080	D.26	PZ	100	0,60
008 099 074	D.28	PZ	100	0,60
008 099 076	D.32	PZ	100	0,60
008 099 086	D.35	PZ	100	1,20
008 099 087	D.40	PZ	100	0,70
008 099 078	D.42	PZ	100	1,40
008 099 077	D.50	PZ	100	1,60



Collare Fermatubo Estensibile Acciaio Inox

CODICE	MISURA	UM	PZ	€
008 057 024	D.80 -140	PZ	100	8,90
008 057 028	D.140-200	PZ	100	7,40



Coppia Fissaggio per Caldaia Murale

CODICE	MISURA	UM	PZ	€
008 099 082		PZ	10	2,20



CODICE	MISURA	UM	PZ	€
008 057 050	D.8 x90	PZ	10	0,90
008 057 002	D.10x120	PZ	10	1,60
008 057 051	D.10x140	PZ	10	1,70
008 057 052	D.10x180	PZ	10	2,40

Fissaggi per Lavabo
Coppia



CODICE	MISURA	UM	PZ	€
008 057 060	D.16x340 mm	PZ	10	18,80
008 057 061	D.16x460 mm	PZ	10	20,50

Fissaggi per Lavabo
Mensola Prolungata Bianco
Coppia



CODICE	MISURA	UM	PZ	€
008 057 003	D.8x90	PZ	10	1,10

Fissaggi per Cassetta
a Parete
Coppia



CODICE	MISURA	UM	PZ	€
008 057 004	D.7x60	PZ	10	4,30

Fissaggi per Wc
Laterale in Metallo
Coppia



CODICE	MISURA	UM	PZ	€
008 057 010	D.7x60	PZ	10	3,50

Fissaggi per Wc
Laterale in ABS
Coppia



CODICE	MISURA	UM	PZ	€
008 057 006	D.6x75 ZINCATO	PZ	10	1,80
008 057 007	D.6x75 OTTONE	PZ	10	3,70
008 057 008	D.6x75 ACCIAIO ZINCATO	PZ	10	3,20

Fissaggi per Wc
Bidet Verticale
Coppia



CODICE	MISURA	UM	PZ	€
008 057 005	D.10x120	PZ	10	1,20

Fissaggi per Scaldacqua
Coppia



CODICE	MISURA	UM	PZ	€
008 057 032	D.10x95	PZ	10	3,10

Fissaggi per Scaldacqua
Tassello Metrico
Coppia





Mensole Radiatori Alluminio
Tonde Zincate
Coppie

CODICE	MISURA	UM	PZ	€
008 099 068	D.70x170 ZINCATE	PZ	10	2,30
008 099 067	D.70x170 BIANCHE	PZ	10	1,60



Mensole Radiatori Ghisa
Tonde Zincate
Coppie

CODICE	MISURA	UM	PZ	€
008 057 011	D.12x205 ZINCATE	PZ	10	4,50
008 057 016	D.12x205 BIANCHE	PZ	10	3,20



Mensole Radiatori Alluminio
Piatte
Coppie

CODICE	MISURA	UM	PZ	€
008 099 081	D.7x170 BIANCHE	PZ	10	1,90
008 099 083	D.7x170 ZINCATE	PZ	10	2,90



Mensole Radiatori Tubolari
Tonde Bianche
Coppie

CODICE	MISURA	UM	PZ	€
008 099 090	D.63x160	PZ	10	2,40
008 099 091	D.63x230	PZ	10	2,90

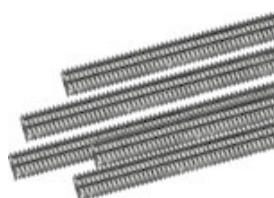

Barra Filettata Zincata

CODICE	MISURA	UM	PZ	€
008 099 050	MM6 x1000	PZ	10	2,00
008 099 051	MM8 x1000	PZ	10	2,70
008 099 052	MM10x1000	PZ	10	3,70
008 099 053	MM12x1000	PZ	10	5,20



Manicotto
per Barra Fiettata Zincata

CODICE	MISURA	UM	PZ	€
008 099 055	MM8 x25	PZ	10	1,80
008 099 056	MM10X30	PZ	10	3,10
008 099 057	MM12X35	PZ	10	3,90



Fascetta Stringitubo
a Banda Forata
Acciaio Inox

CODICE	MISURA	UM	PZ	€
008 057 070	Dn. 10-16 mm	PZ	100	0,60
008 057 071	Dn. 12-22 mm	PZ	100	0,60
008 057 072	Dn. 16-28 mm	PZ	100	0,60
008 057 073	Dn. 20-32 mm	PZ	100	0,60
008 057 074	Dn. 25-42 mm	PZ	50	0,70
008 057 075	Dn. 32-52 mm	PZ	50	0,80
008 057 076	Dn. 47-67 mm	PZ	50	0,80
008 057 077	Dn. 77-97 mm	PZ	50	0,80



CODICE	MISURA	UM	PZ	€
009 022 130	D.32 x 250	PZ	20	1,60
009 022 131	D.32 x 500	PZ	20	2,50
009 022 132	D.32 x 750	PZ	20	2,70
009 022 133	D.32 x1000	PZ	24	4,10
009 022 134	D.32 x1500	PZ	24	5,30
009 022 135	D.32 x2000	PZ	24	7,50
009 022 136	D.32 x3000	PZ	24	10,40
009 022 001	D.40 x 150	PZ	20	1,10
009 022 002	D.40 x 250	PZ	20	1,40
009 022 003	D.40 x 500	PZ	20	2,00
009 022 004	D.40 x 750	PZ	10	2,40
009 022 005	D.40 x1000	PZ	20	3,30
009 022 006	D.40 x1500	PZ	20	4,30
009 022 007	D.40 x2000	PZ	20	6,40
009 022 009	D.40 x3000	PZ	20	9,20
009 022 010	D.50 x 150	PZ	20	1,30
009 022 011	D.50 x 250	PZ	20	1,70
009 022 012	D.50 x 500	PZ	20	2,50
009 022 013	D.50 x 750	PZ	30	2,90
009 022 014	D.50 x1000	PZ	20	3,90
009 022 123	D.50 x1500	PZ	20	6,60
009 022 015	D.50 x2000	PZ	20	8,10
009 022 016	D.50 x3000	PZ	20	11,80
009 022 116	D.75 x 150	PZ	20	1,60
009 022 117	D.75 x 250	PZ	20	2,20
009 022 118	D.75 x 500	PZ	20	3,30
009 022 119	D.75 x 750	PZ	20	4,50
009 022 120	D.75 x1000	PZ	20	6,00
009 022 121	D.75 x1500	PZ	20	9,00
009 022 122	D.75 x2000	PZ	20	11,30
009 022 124	D.75 x3000	PZ	20	15,80
009 022 275	D.90 x 250	PZ	20	3,40
009 022 276	D.90 x 500	PZ	10	5,90
009 022 277	D.90 x1000	PZ	10	9,60
009 022 278	D.90 x1500	PZ	10	13,20
009 022 279	D.90 x2000	PZ	10	18,80
009 022 280	D.90 x3000	PZ	10	31,10
009 022 017	D.110x 250	PZ	20	4,10
009 022 018	D.110x 500	PZ	10	6,70
009 022 019	D.110x 750	PZ	15	8,60
009 022 020	D.110x1000	PZ	15	11,30
009 022 021	D.110x1500	PZ	15	15,00
009 022 022	D.110x2000	PZ	15	23,00
009 022 023	D.110x3000	PZ	15	35,20
009 022 156	D.125x 250	PZ	10	5,70
009 022 157	D.125x 500	PZ	5	10,00
009 022 158	D.125x 750	PZ	8	14,60
009 022 159	D.125x1000	PZ	8	19,60
009 022 160	D.125x1500	PZ	8	25,00
009 022 161	D.125x2000	PZ	8	32,60
009 022 162	D.125x3000	PZ	8	50,10

Tube di Scarico
in Polipropilene PP
ad Innesto HTEM
1 Bicchiere





Tubo di Scarico
in Polipropilene PP
ad Innesto HTEM
2 Bicchieri



CODICE	MISURA	UM	PZ	€
009 022 151	D.32 x 500	PZ	30	4,10
009 022 152	D.32 x1000	PZ	24	4,60
009 022 153	D.32 x1500	PZ	24	6,60
009 022 154	D.32 x2000	PZ	24	8,70
009 022 155	D.32 x3000	PZ	24	11,60
009 022 081	D.40 x 500	PZ	35	2,60
009 022 082	D.40 x1000	PZ	20	3,80
009 022 083	D.40 x1500	PZ	20	5,90
009 022 084	D.40 x2000	PZ	20	6,90
009 022 085	D.40 x3000	PZ	20	10,10
009 022 086	D.50 x 500	PZ	25	3,10
009 022 087	D.50 x1000	PZ	30	4,60
009 022 088	D.50 x1500	PZ	30	6,90
009 022 089	D.50 x2000	PZ	30	9,00
009 022 090	D.50 x3000	PZ	30	12,60
009 022 166	D.75 x 500	PZ	10	4,70
009 022 167	D.75 x1000	PZ	10	7,40
009 022 168	D.75 x1500	PZ	10	9,80
009 022 169	D.75 x2000	PZ	10	13,50
009 022 170	D.75 x3000	PZ	10	19,70
009 022 282	D.90 x 500	PZ	8	7,60
009 022 283	D.90 x1000	PZ	10	12,50
009 022 284	D.90 x1500	PZ	10	13,70
009 022 285	D.90 x2000	PZ	10	21,20
009 022 286	D.90 x3000	PZ	10	32,70
009 022 091	D. 110x500	PZ	12	8,50
009 022 092	D.110x1000	PZ	10	14,00
009 022 093	D.110x1500	PZ	10	17,80
009 022 094	D.110x2000	PZ	10	23,80
009 022 095	D.110x3000	PZ	10	36,80
009 022 173	D.125x 500	PZ	6	13,80
009 022 174	D.125x1000	PZ	8	22,70
009 022 175	D.125x1500	PZ	8	27,00
009 022 176	D.125x2000	PZ	8	43,50
009 022 177	D.125x3000	PZ	8	50,50



Scivolina Lubrificante
per Tubi in PP Tubetto

CODICE	MISURA	UM	PZ	€
009 022 064	Gr 250	PZ	12	4,70



Scivolina per Tubi
e Raccordi in PP Spray

CODICE	MISURA	UM	PZ	€
004 005 010	MI 400	PZ	12	9,70



CODICE	MISURA	UM	PZ	€
009 022 185	D.32 -15°	PZ	10	1,50
009 022 097	D.40 -15°	PZ	10	1,20
009 022 027	D.50 -15°	PZ	10	1,30
009 022 180	D.75 -15°	PZ	10	2,40
009 022 288	D.90 -15°	PZ	10	3,90
009 022 031	D.110-15°	PZ	10	4,30
009 022 186	D.125-15°	PZ	10	10,90

Curva PP HTB
ad Innesto 15°



CODICE	MISURA	UM	PZ	€
009 022 187	D.32 -30°	PZ	10	1,50
009 022 024	D.40 -30°	PZ	10	1,20
009 022 028	D.50 -30°	PZ	10	1,40
009 022 181	D.75 -30°	PZ	10	2,30
009 022 289	D.90 -30°	PZ	10	3,90
009 022 032	D.110-30°	PZ	10	4,30
009 022 188	D.125-30°	PZ	10	10,10

Curva PP HTB
ad Innesto 30°



CODICE	MISURA	UM	PZ	€
009 022 140	D.32 -45°	PZ	10	1,50
009 022 098	D.40 -45°	PZ	10	1,20
009 022 100	D.50 -45°	PZ	10	1,40
009 022 182	D.75 -45°	PZ	10	2,50
009 022 290	D.90 -45°	PZ	10	3,90
009 022 033	D.110-45°	PZ	10	4,30
009 022 189	D.125-45°	PZ	10	10,90

Curva PP HTB
ad Innesto 45°



CODICE	MISURA	UM	PZ	€
009 022 190	D.32 -67°	PZ	10	1,40
009 022 025	D.40 -67°	PZ	10	1,30
009 022 029	D.50 -67°	PZ	10	1,50
009 022 183	D.75 -67°	PZ	10	2,40
009 022 291	D.90 -67°	PZ	10	3,60
009 022 034	D.110-67°	PZ	10	4,10
009 022 191	D.125-67°	PZ	10	10,10

Curva PP HTB
ad Innesto 67°



CODICE	MISURA	UM	PZ	€
009 022 141	D.32 -87°	PZ	10	1,50
009 022 026	D.40 -87°	PZ	10	1,20
009 022 099	D.50 -87°	PZ	10	1,40
009 022 184	D.75 -87°	PZ	10	2,50
009 022 292	D.90 -87°	PZ	10	3,90
009 022 035	D.110-87°	PZ	10	4,30
009 022 192	D.125-87°	PZ	10	10,90

Curva PP HTB
ad Innesto 87°





Curva Ridotta PP HTBR
ad Innesto 87°

CODICE	MISURA	UM	PZ	€
009 022 196	D.40x50-87°	PZ	10	2,30



Braga Doppia Ridotta PP
HTDA ad Innesto 67°

CODICE	MISURA	UM	PZ	€
009 022 260	D.110x110x110-67°	PZ	10	21,00



Braga Doppia Ridotta PP
HTDA ad Innesto 45°

CODICE	MISURA	UM	PZ	€
009 022 263	D.125x110x110-45°	PZ	10	38,20
009 022 261	D.110x40 x 40 -45°	PZ	10	21,00
009 022 262	D.110x50 x 50 -45°	PZ	10	21,00



Braga PP HTEA
ad Innesto 45°

CODICE	MISURA	UM	PZ	€
009 022 145	D.32 x32 -45°	PZ	10	3,10
009 022 036	D.40 x40 -45°	PZ	10	2,20
009 022 037	D.50 x50 -45°	PZ	10	2,80
009 022 200	D.75 x75 -45°	PZ	10	5,00
009 022 294	D.90 x90 -45°	PZ	10	7,00
009 022 038	D.110x110-45°	PZ	10	8,10
009 022 201	D.125x125-45°	PZ	10	34,60



Braga PP HTEA
ad Innesto 87°

CODICE	MISURA	UM	PZ	€
009 022 146	D.32 x32 -87°	PZ	10	3,10
009 022 039	D.40 x40 -87°	PZ	10	2,00
009 022 040	D.50 x50 -87°	PZ	10	2,80
009 022 204	D.75 x75 -87°	PZ	10	3,20
009 022 295	D.90 x90 -87°	PZ	10	6,80
009 022 041	D.110x110-87°	PZ	10	8,10
009 022 205	D.125x125-87°	PZ	10	34,50



Braga Ridotta PP HTEA
ad Innesto 45°

CODICE	MISURA	UM	PZ	€
009 022 208	D.40 x32 -45°	PZ	10	3,10
009 022 073	D.50 x40 -45°	PZ	10	2,30
009 022 209	D.75 x40 -45°	PZ	10	3,80
009 022 210	D.75 x50 -45°	PZ	10	4,10
009 022 297	D.90 x40 -45°	PZ	10	5,10
009 022 075	D.110x40 -45°	PZ	10	5,30
009 022 074	D.110x50 -45°	PZ	10	5,40
009 022 211	D.110x75 -45°	PZ	10	7,70
009 022 212	D.125x110-45°	PZ	10	27,40
009 022 299	D.90 x50 -45°	PZ	10	5,20



CODICE	MISURA	UM	PZ	€
009 022 216	D.32	PZ	10	2,30
009 022 042	D.40	PZ	10	1,70
009 022 043	D.50	PZ	10	2,20
009 022 217	D.75	PZ	10	2,90
009 022 300	D.90	PZ	10	4,30
009 022 044	D.110	PZ	10	5,10
009 022 218	D.125	PZ	10	11,20

Manicotto PP HTMM
con Battente ad Innesto



CODICE	MISURA	UM	PZ	€
009 022 045	D.32 x 40	PZ	10	2,40
009 022 046	D.40 x 50	PZ	10	2,40
009 022 306	D.40 x 90	PZ	10	3,00
009 022 047	D.40 x110	PZ	10	3,30
009 022 228	D.50 x 75	PZ	10	2,40
009 022 308	D.50 x 90	PZ	10	3,30
009 022 048	D.50 x110	PZ	10	3,50
009 022 229	D.75 x110	PZ	10	3,80
009 022 307	D.90 x110	PZ	10	4,30
009 022 301	D.110x125	PZ	10	9,10

Aumento PP HTV
Incasso Femmina Maschio
ad Innesto



CODICE	MISURA	UM	PZ	€
009 022 265	D.32-40x110	PZ	10	14,90
009 022 266	D.40-40x110	PZ	10	15,70
009 022 267	D.40-50x125	PZ	10	19,30

Aumento PP HTV
Doppio Incasso Femmina
Maschio ad Innesto



CODICE	MISURA	UM	PZ	€
009 022 298	D.90 x40 -87°	PZ	10	4,70
009 022 316	D.90 x50 -87°	PZ	10	5,20
009 022 233	D.110x40 -87°	PZ	10	4,70
009 022 234	D.110x50 -87°	PZ	10	5,00
009 022 235	D.110x75 -87°	PZ	10	7,00
009 022 236	D.125x110-87°	PZ	10	9,10

Braga Ridotta PP HTEA
ad Innesto 87°



CODICE	MISURA	UM	PZ	€
009 022 238	D.40x32	PZ	10	2,70
009 022 080	D.50x40	PZ	10	2,60
009 022 239	D.75x50	PZ	10	2,70

Riduzione PP HTRR
Femmina Maschio
ad Innesto



CODICE	MISURA	UM	PZ	€
009 022 240	D.40x46	PZ	10	1,30

Manicotto Tecnico PP HTS
ad Innesto



CODICE	MISURA	UM	PZ	€
009 022 225	D.100x110	PZ	10	10,30

Manicotto Doppio Bicchiera
Ridotto PP e PVC
ad Innesto Valsir



CODICE	MISURA	UM	PZ	€
009 022 226	D.90 x D.110	PZ	10	8,30

Manicotto Aumento PP
Concentrico Maschio D.90
Femmina D.110 ad Innesto
Valsir





Curva Tecnica PP HTSW ad Innesto

CODICE	MISURA	UM	PZ	€
009 022 051	D.40x46	PZ	10	1,60
009 022 052	D.50x54	PZ	10	2,00



Curva Tecnica Doppia PP HTSW ad Innesto

CODICE	MISURA	UM	PZ	€
009 022 324	D.40x50x50	PZ	10	3,80



Curva Tecnica Prolungata PP HTSW ad Innesto

CODICE	MISURA	UM	PZ	€
009 022 053	D.40x46	PZ	10	2,00
009 022 322	D.40x50	PZ	10	2,00



Tronchetto PP-PVC con O.Ring Femmina Maschio ad Innesto

CODICE	MISURA	UM	PZ	€
009 022 108	D.110x100	PZ	10	8,40



Guarnizione per Tronchetto

CODICE	MISURA	UM	PZ	€
009 022 109	D.100	PZ	10	1,60



Raccordo Passaggio PP-PVC M1HG Femmina Maschio ad Innesto

CODICE	MISURA	UM	PZ	€
009 022 077	D.40 x40	PZ	10	5,10
009 022 078	D.50 x50	PZ	10	4,90
009 022 079	D.110x100	PZ	10	17,00
009 022 254	D.125x125	PZ	10	16,60



Raccordo Passaggio Prolungato PP-PVC Innesto

CODICE	MISURA	UM	PZ	€
009 022 076	D.110F x 100M M1VTGL	PZ	10	17,00
009 022 315	D.110M x 100F M1VTGL	PZ	10	9,60



Raccordo Passaggio Eccentrico PP-PVC Innesto

CODICE	MISURA	UM	PZ	€
009 022 252	D.75F x 100M M1PTG	PZ	10	11,30
009 022 253	D.110F x125M M1PTG	PZ	10	11,90
009 022 311	D.90F X110m M1PTG	PZ	10	12,20



Curva Passaggio PP-PVC ad Innesto

CODICE	MISURA	UM	PZ	€
009 022 310	D.100x110-45° C4VTG	pz	10	12,50



Curva Passaggio PP-PVC ad Innesto

CODICE	MISURA	UM	PZ	€
009 022 293	D.100x110-87° C8VTG	PZ	10	11,50



Raccordo Passaggio PP Ghisa ad Innesto

CODICE	MISURA	UM	PZ	€
009 022 330	D.50 MTRPV	PZ	10	7,80
009 022 331	D.75 MTRPV	PZ	10	9,50
009 022 332	D.110 MTRPV	PZ	10	11,50



CODICE	MISURA	UM	PZ	€
009 022 335	D.90 x350	PZ	10	11,50
009 022 336	D.110x350	PZ	10	11,50

Curva Wc PP Prolungata con Guarnizione ad Innesto Bonomini



CODICE	MISURA	UM	PZ	€
009 022 063	D.90 HTCWBS	PZ	10	12,20
009 022 054	D.110 HTCWBS	PZ	10	12,80

Curva Wc PP Prolungata con Guarnizione ad Innesto



CODICE	MISURA	UM	PZ	€
009 022 256	D.90 x40 Orientabili HTCWSH1G	PZ	10	16,50
009 022 258	D.90 x50 Orientabili HTCWSH1G	PZ	10	17,00
009 022 055	D.110x40 HTCWSH1G	PZ	10	17,40
009 022 056	D.110x50 HTCWSH1G	PZ	10	19,30

Curva Wc PP Prolungata Attacco Sx con Guarnizione ad Innesto



CODICE	MISURA	UM	PZ	€
009 022 257	D.90 x40 Orientabili HTCWSH1D	PZ	10	16,50
009 022 259	D.90 x50 Orientabili HTCWSH1D	PZ	10	17,00
009 022 057	D.110x40 HTCWSH1D	PZ	10	17,40
009 022 058	D.110x50 HTCWSH1D	PZ	10	19,30

Curva Wc PP Prolungata Attacco Dx con Guarnizione ad Innesto



CODICE	MISURA	UM	PZ	€
009 022 059	D.110x40 HTCWH2	PZ	10	24,40
009 022 060	D.110x50 HTCWH2	PZ	10	24,80
009 022 068	D.90 x40 Orientabili HTCWH2	PZ	10	22,20
009 022 069	D.90 x50 Orientabili HTCWH2	PZ	10	22,60

Curva Wc PP Prolungata Attacco Dx-SX con Guarnizione ad Innesto



CODICE	MISURA	UM	PZ	€
009 022 061	D.110x40 HTCW3H1F	PZ	10	13,50
009 022 062	D.110x50 HTCW3H1F	PZ	10	13,90

Curva Wc PP Prolungata Attacco Posteriore con Guarnizioni ad Innesto



CODICE	MISURA	UM	PZ	€
009 022 096	D.110x16 cm HTSK	PZ	10	9,00
009 022 245	D.90 x50 cm HTSK	PZ	10	10,80

Manicotto Wc Diritto PP con Guarnizione ad innesto



CODICE	MISURA	UM	PZ	€
009 022 244	D.110x25 cm HTSK	PZ	10	11,90
009 022 243	D.90 x25 cm HTSK	PZ	10	10,90

Manicotto Wc Eccentrico PP con Guarnizione ad innesto





SETTORE 009
IDRAULICA



Gomito Wc a Parete Collo Cigno PP ad Innesto Bonomini

CODICE	MISURA	UM	PZ	€
009 022 255	D.110	PZ	10	10,70
009 022 247	D.90	PZ	10	10,70



Gomito Wc Flessibile Estensibile Mago Bonomini

CODICE	MISURA	UM	PZ	€
009 022 268	D.80/100F-100/110M	PZ	10	29,50



Rosone Wc Bianco Valsir

CODICE	MISURA	UM	PZ	€
009 022 339	D.90	PZ	10	6,30
009 022 340	D.110	PZ	10	6,70



Pozzetto Alto a Pavimento 4 Vie PP ad Innesto

CODICE	MISURA	UM	PZ	€
009 022 110	D.110x40x40	PZ	10	7,30
009 022 066	D.110x40x50	PZ	10	7,30



Bicchiere Tripla Profondità PP ad Innesto

CODICE	MISURA	UM	PZ	€
009 022 323	D.110 HT3BV	PZ	10	7,50



Bicchiere Tripla Profondità PP

CODICE	MISURA	UM	PZ	€
009 022 345	D. 40 Valsir VS0531001 HTLL3	PZ	10	3,60
009 022 346	D. 50 Valsir VS0531003 HTLL3	PZ	10	4,00
009 022 347	D. 75 Valsir VS0531005 HTLL3	PZ	10	3,60
009 022 348	D. 90 Valsir VS0599123 HTLL3	PZ	10	3,60
009 022 350	D.125 Valsir VS0531009 HTLL3	PZ	10	18,10



Braga di Ispezione PP con Tappo e Vite ad Innesto

CODICE	MISURA	UM	PZ	€
009 022 320	D.110x90 HTPV	PZ	10	8,60



CODICE	MISURA	UM	PZ	€
009 070 009	D.120	PZ	10	2,60

Guarnizione per Curva Wc Valsir



CODICE	MISURA	UM	PZ	€
009 070 008	D.120	PZ	10	2,30

Anello Bloccaggio per Curva Wc Valsir



CODICE	MISURA	UM	PZ	€
009 022 246	D.120	PZ	10	4,80

Anello Bloccaggio e Guarnizione per Curva Wc Valsir



CODICE	MISURA	UM	PZ	€
009 070 035	D.120	PZ	10	1,70

Guarnizione per Curva WC



CODICE	MISURA	UM	PZ	€
009 070 036	D.120	PZ	10	1,70

Anello di Bloccaggio per Curva Wc



CODICE	MISURA	UM	PZ	€
009 070 127	D.100	PZ	10	6,20

Tappo e Piattello Grigliato per Pozzetto



CODICE	MISURA	UM	PZ	€
009 070 141	D.100	PZ	10	3,50

Piattello Grigliato per Pozzetto



CODICE	MISURA	UM	PZ	€
009 070 400	D.100	PZ	10	3,00

Tappo e Piattello Chiuso per Pozzetto



CODICE	MISURA	UM	PZ	€
009 070 405	D.100 e Piatt. D.125	PZ	10	5,50

CODICE	MISURA	UM	PZ	€
009 070 142	D.100	PZ	10	2,40

Piattello Inox Chiuso per Pozzetto



CODICE	MISURA	UM	PZ	€
009 070 139	D.100	PZ	10	2,90

Tappo Chiuso per Pozzetto





Sifone Incasso per Lavatrice
in PP Bianco Geberit

CODICE	MISURA	UM	PZ	€
007 078 020	D.40x1"1/2	PZ	10	28,10



Sifone Lavatrice Incasso
PP per Tubi ad Innesto

CODICE	MISURA	UM	PZ	€
009 022 070	D.40x1"1/2	PZ	10	8,00



Sifone Lavatrice Esterno Bianco
PP per Tubi ad Innesto

CODICE	MISURA	UM	PZ	€
009 022 067	D.32	PZ	10	7,20



Tappo di Chiusura
PP per Tubi ad Innesto

CODICE	MISURA	UM	PZ	€
009 022 248	D.32	PZ	10	0,90
009 022 112	D.40	PZ	10	0,80
009 022 102	D.50	PZ	10	1,10
009 022 249	D.75	PZ	10	1,80
009 022 309	D.90	PZ	10	2,40
009 022 103	D.110	PZ	10	2,70
009 022 250	D.125	PZ	10	6,00



Sifone Firenze Orizzontale
in PP con Tappo ad Innesto

CODICE	MISURA	UM	PZ	€
009 022 113	D.110	PZ	10	47,60
009 022 251	D.125	PZ	10	102,80



Curva Wc Normale per Tubi
Incollaggio senza Guarnizione

CODICE	MISURA	UM	PZ	€
009 070 030	D.100x110	PZ	10	4,80



Curva Wc 2 Uscite per Tubi
Incollaggio senza Guarnizione

CODICE	MISURA	UM	PZ	€
009 070 027	D.100x40x40	PZ	10	9,00
009 070 024	D.100x50x50	PZ	10	9,00



Pozzetto Alto 4 Vie per Tubi
ad Incollaggio

CODICE	MISURA	UM	PZ	€
009 070 401	D.100x40	PZ	10	6,10



Tronchetto Dritto Wc con
Guarnizione per Tubi ad
Incollaggio

CODICE	MISURA	UM	PZ	€
009 070 043	D.100Mx110F	PZ	10	9,30



CODICE	MISURA	UM	PZ	€
009 070 061	D.40	PZ	10	0,40
009 070 201	D.50	Pz	10	0,50

CODICE	MISURA	UM	PZ	€
009 070 023	D.40x1"1/2	PZ	10	12,00

CODICE	MISURA	UM	PZ	€
009 070 303	D.30x8	PZ	10	0,90

CODICE	MISURA	UM	PZ	€
009 070 041	D.30x45°	PZ	10	8,30
009 070 390	D.32x45° Valsir	PZ	10	30,60

CODICE	MISURA	UM	PZ	€
009 070 052	D.30x90°	PZ	10	8,30
009 070 391	D.30x90° Valsir	PZ	10	32,40

CODICE	MISURA	UM	PZ	€
007 124 108	D.200x200	PZ	10	9,70
007 124 107	D.300x300	PZ	10	21,80
007 124 109	D.400x400	PZ	10	46,20
007 124 110	D.550x550	PZ	10	114,40

CODICE	MISURA	UM	PZ	€
007 124 159	D.200x200	PZ	10	5,50
007 124 160	D.300x300	PZ	10	8,30
007 124 161	D.400x400	PZ	10	18,90
007 124 162	D.550x550	PZ	10	53,40

CODICE	MISURA	UM	PZ	€
007 124 111	D.200x200	PZ	10	5,60
007 124 112	D.300x300	PZ	10	10,50
007 124 113	D.400x400	PZ	10	18,10
007 124 114	D.550x550	PZ	10	49,30

CODICE	MISURA	UM	PZ	€
007 124 170	D.400x400	PZ	10	32,30
007 124 171	D.550x550	PZ	10	53,90

CODICE	MISURA	UM	PZ	€
007 124 073	D.40 x100x100	PZ	10	2,20
007 124 074	D.50 x150x150	PZ	10	3,40
007 124 075	D.80 x200x200	PZ	10	7,60
007 124 076	D.100x250x250	PZ	10	11,40

CODICE	MISURA	UM	PZ	€
007 124 140	D.100x100x40	PZ	10	4,80
007 124 141	D.150x150x40	PZ	10	14,60

CODICE	MISURA	UM	PZ	€
009 070 025	D.50x40	PZ	10	17,30

Tappo Cieco di Chiusura Grigio ad Incollaggio



Sifone Lavatrice Incasso Pvc per Tubi ad Incollaggio



O-Ring Guarnizione per Tubo di Cacciata Bonomini



Tubo di Cacciata da Incasso



Tubo di Cacciata da Incasso



Pozzetto in PP con Tappo di Chiusura



Coperchio Chiuso per Pozzetto in PP

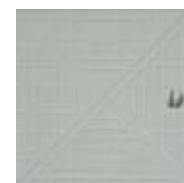

Coperchio Grigliato per Pozzetto in PP



Tappo Ermetico per Pozzetto in PP



Chiusino Sifonato per Pavimento Grigio



Chiusino Orientabile a 360° Sifonato Grigio



Sifone Orinatoio "S" Esterno Omp





SETTORE 009

IDRAULICA



Gomito Pvc Rosso
ad Incollaggio a 45°

CODICE	MISURA	UM	PZ	€
009 070 193	D.32 -45°	PZ	20	0,60
009 070 086	D.40 -45°	PZ	20	0,70
009 070 089	D.50 -45°	PZ	20	1,00
009 070 084	D.63 -45°	PZ	20	1,40
009 070 082	D.80 -45°	PZ	20	1,70
009 070 092	D.100-45°	PZ	30	2,10
009 070 094	D.125-45°	PZ	20	3,50
009 070 095	D.140-45°	PZ	5	5,00
009 070 258	D.160-45°	PZ	5	6,00
009 070 146	D.200-45°	PZ	5	11,50



Gomito Pvc Rosso
ad Incollaggio a 87°

CODICE	MISURA	UM	PZ	€
009 070 088	D.32 -87°	PZ	20	0,70
009 070 087	D.40 -87°	PZ	20	0,80
009 070 090	D.50 -87°	PZ	20	1,10
009 070 085	D.63 -87°	PZ	20	1,50
009 070 083	D.80 -87°	PZ	20	1,90
009 070 091	D.100-87°	PZ	30	2,30
009 070 056	D.125-87°	PZ	20	4,00
009 070 101	D.140-87°	PZ	5	5,90
009 070 259	D.160-87°	PZ	5	7,40
009 070 147	D.200-87°	PZ	5	13,70



Braga Pvc Rosso
ad Incollaggio a 45°

CODICE	MISURA	UM	PZ	€
009 070 097	D.32 -45°	PZ	10	1,00
009 070 096	D.40 -45°	PZ	10	1,40
009 070 099	D.50 -45°	PZ	10	1,80
009 070 105	D.63 -45°	PZ	10	2,40
009 070 081	D.80 -45°	PZ	10	3,60
009 070 104	D.100-45°	PZ	10	4,10
009 070 058	D.125-45°	PZ	10	6,40
009 070 150	D.140-45°	PZ	10	10,10
009 070 191	D.160-45°	PZ	10	13,30
009 070 132	D.200-45°	PZ	10	29,60



Gomito Pvc Rosso
ad Incollaggio a 87°

CODICE	MISURA	UM	PZ	€
009 070 190	D.32 -87°	PZ	10	1,20
009 070 098	D.40 -87°	PZ	10	1,40
009 070 133	D.50 -87°	PZ	10	1,80
009 070 144	D.63 -87°	PZ	10	2,40
009 070 256	D.80 -87°	PZ	10	3,60
009 070 106	D.100-87°	PZ	10	4,10
009 070 057	D.125-87°	PZ	10	6,40
009 070 145	D.140-87°	PZ	10	10,10
009 070 149	D.160-87°	PZ	10	13,30
009 070 148	D.200-87°	PZ	10	29,60



CODICE	MISURA	UM	PZ	€
009 070 209	D.50	PZ	10	3,00
009 070 210	D.63	PZ	10	3,10
009 070 211	D.80	PZ	10	3,30
009 070 130	D.100	PZ	10	4,20
009 070 213	D.125	PZ	10	5,20
009 070 214	D.140	PZ	10	6,10
009 070 215	D.160	PZ	10	15,80
009 070 216	D.200	PZ	10	19,00

Tappo Ispezionabile
Pvc Rosso ad Incollaggio



CODICE	MISURA	UM	PZ	€
009 070 102	D.100x40-45°	PZ	10	4,20
009 070 103	D.100x50-45°	PZ	10	4,20
009 070 110	D.125x40-45°	PZ	10	7,30
009 070 111	D.125x50-45°	PZ	10	7,30

Braga Ridotta
Pvc Rosso
ad Incollaggio



CODICE	MISURA	UM	PZ	€
009 070 377	D.100	PZ	1	130,60
009 070 378	D.125	PZ	1	148,70
009 070 379	D.140	PZ	1	166,80
009 070 380	D.160	PZ	1	219,00
009 070 381	D.200	PZ	1	296,50

Valvola Antiritorno
Pvc Rosso
ad Incollaggio



CODICE	MISURA	UM	PZ	€
009 070 294	D.80	PZ	10	28,50
009 070 295	D.100	PZ	10	32,80
009 070 296	D.125	PZ	10	35,90
009 070 297	D.140	PZ	10	49,60
009 070 298	D.160	PZ	10	62,20
009 070 299	D.200	PZ	10	106,60

Sifone Firenze
Pvc Rosso
1 Tappo ad Incollaggio



CODICE	MISURA	UM	PZ	€
009 070 301	D.100	PZ	10	41,20
009 070 302	D.125	PZ	10	45,40

Sifone Firenze
Pvc Rosso
2 Tappi ad Incollaggio





Riduzione Pvc Rosso ad Incollaggio

CODICE	MISURA	UM	PZ	€
009 070 281	D.32 x40	PZ	10	1,10
009 070 162	D.40 x50	PZ	10	1,30
009 070 163	D.40 x63	PZ	10	1,70
009 070 165	D.40 x80	PZ	10	2,00
009 070 264	D.40 x100	PZ	10	3,00
009 070 158	D.40 x125	PZ	10	3,70
009 070 164	D.50 x63	PZ	10	1,70
009 070 300	D.50 x80	PZ	10	2,10
009 070 160	D.50 x100	PZ	10	3,00
009 070 265	D.50 x125	PZ	10	3,70
009 070 245	D.63 x80	PZ	10	2,10
009 070 161	D.63 x100	PZ	10	2,90
009 070 287	D.63 x125	PZ	10	3,90
009 070 159	D.80 x100	PZ	10	3,00
009 070 153	D.80 x100	PZ	10	3,80
009 070 266	D.100x125	PZ	10	3,80
009 070 267	D.100x140	PZ	10	4,70
009 070 269	D.100x160	PZ	10	7,80
009 070 272	D.100x200	PZ	10	13,20
009 070 268	D.125x140	PZ	10	4,70
009 070 270	D.125x160	PZ	10	7,80
009 070 273	D.125x200	PZ	10	13,40
009 070 271	D.140x160	PZ	10	7,80
009 070 274	D.140x200	PZ	10	13,40
009 070 275	D.160x200	PZ	10	13,40



Aumento Pvc Rosso ad Incollaggio

CODICE	MISURA	UM	PZ	€
009 070 172	D.32 x40	PZ	10	0,80
009 070 181	D.40 x50	PZ	10	1,30
009 070 173	D.40 x63	PZ	10	1,70
009 070 175	D.50 x63	PZ	10	1,70
009 070 179	D.40 x80	PZ	10	2,10
009 070 278	D.50 x80	PZ	10	2,10
009 070 152	D.63 x80	PZ	10	2,10
009 070 174	D.40 x100	PZ	10	3,00
009 070 171	D.50 x100	PZ	10	3,00
009 070 176	D.63 x100	PZ	10	3,00
009 070 167	D.80 x100	PZ	10	3,00
009 070 166	D.40 x125	PZ	10	3,90
009 070 257	D.50 x125	PZ	10	3,80
009 070 277	D.63 x125	PZ	10	4,10
009 070 182	D.80 x125	PZ	10	3,80
009 070 169	D.100x125	PZ	10	3,80
009 070 100	D.100x140	PZ	10	4,70
009 070 151	D.100x160	PZ	10	7,90
009 070 260	D.100x200	PZ	10	12,80
009 070 168	D.125x140	PZ	10	4,70
009 070 080	D.125x160	PZ	10	7,80
009 070 261	D.125x200	PZ	10	12,80
009 070 177	D.140x160	PZ	10	7,60
009 070 170	D.140x200	PZ	10	13,40
009 070 262	D.160x200	PZ	10	12,80



CODICE	MISURA	UM	PZ	€
009 070 066	D.100	PZ	10	11,80
009 070 067	D.125	PZ	10	16,10
009 070 068	D.160	PZ	10	39,80

Giunto di Dilatazione
Con Guarnizione a Labbro
Pvc Rosso ad Incollaggio



CODICE	MISURA	UM	PZ	€
009 070 135	D.40	PZ	10	8,50
009 070 136	D.50	PZ	10	8,50
009 070 137	D.63	PZ	10	8,40
009 070 138	D.80	PZ	10	9,10
009 070 070	D.100	PZ	10	9,50
009 070 071	D.125	PZ	10	11,90
009 070 072	D.140	PZ	10	28,70
009 070 073	D.160	PZ	10	32,90
009 070 069	D.200	PZ	10	40,20

Giunto di Riparazione
Pvc Rosso ad Incollaggio



CODICE	MISURA	UM	PZ	€
009 152 003	D.40 x3 mt	PZ	10	6,80
009 152 002	D.40 x2 mt	PZ	10	5,20
009 152 001	D.40 x1 mt	PZ	10	3,10
009 152 010	D.50 x3 mt	PZ	10	8,60
009 152 011	D.50 x2 mt	PZ	10	6,60
009 152 012	D.50 x1 mt	PZ	10	3,90
009 152 013	D.63 x3 mt	PZ	10	10,90
009 152 014	D.63 x2 mt	PZ	10	8,40
009 152 015	D.63 x1 mt	PZ	10	4,90
009 152 020	D.80 x3 mt	PZ	10	12,40
009 152 021	D.80 x2 mt	PZ	10	9,60
009 152 022	D.80 x1 mt	PZ	10	5,70
009 152 004	D.100x3 mt	PZ	10	13,50
009 152 005	D.100x2 mt	PZ	10	10,40
009 152 006	D.100x1 mt	PZ	10	6,10
009 152 007	D.125x3 mt	PZ	10	17,70
009 152 008	D.125x2 mt	PZ	10	13,80
009 152 009	D.125x1 mt	PZ	10	8,00
009 152 016	D.140x3 mt	PZ	10	23,10
009 152 017	D.140x2 mt	PZ	10	18,20
009 152 019	D.140x1 mt	PZ	10	10,60
009 152 023	D.160x3 mt	PZ	10	24,80
009 152 024	D.160x2 mt	PZ	10	19,30
009 152 025	D.160x1 mt	PZ	10	12,00
009 152 026	D.200x3 mt	PZ	10	38,90
009 152 027	D.200x2 mt	PZ	10	30,20
009 152 028	D.200x1 mt	PZ	10	17,90

Tubo Pvc Rosso a Barre
con Bicchiere Liscio





Cassetta da Incasso Grohe
Completa di Placca Air e Canotto
Cassetta 38863
Placca Air Bianca 38505SHO
Canotto 37103SHO

CODICE	MISURA	UM	PZ	€
009 077 020	Grohe	PZ	1	236,40



Cassetta da Incasso Grohe
Completa di Placca Skate Bianca
e Canotto - Cassetta 38863
Placca 38732SHO
Canotto 37103SHO

CODICE	MISURA	UM	PZ	€
009 077 002	Grohe	PZ	1	236,40



Cassetta da Incasso Grohe
Completa di Placca Skate Cromata
e Canotto - Cassetta 38863
Placca 38732000
Canotto 37103SHO

CODICE	MISURA	UM	PZ	€
009 077 011	Grohe	PZ	1	269,20



Cassetta da Incasso Grohe
Completa di Placca Arena
e Canotto - Cassetta 38863
Placca 38844SHO
Canotto 37103SHO

CODICE	MISURA	UM	PZ	€
009 077 019	Grohe	PZ	1	252,80



Cassetta da Incasso Grohe
38863 Solo Cassetta non
Completa

CODICE	MISURA	UM	PZ	€
009 077 001	Grohe	PZ	1	170,70



Cassetta da Incasso Grohe
C/Placca Skate e Canotto
Modulo Wc Sospeso

CODICE	MISURA	UM	PZ	€
009 077 006	Grohe 38729+38732SHO	PZ	1	426,80



Piastra di Azionamento
Cosmopolitan Cromo Grohe

CODICE	MISURA	UM	PZ	€
009 077 017	Grohe 38732000	PZ	1	123,10



Piastra di Azionamento Skate
Cromo Grohe

CODICE	MISURA	UM	PZ	€
009 077 016	Grohe 38862000	PZ	1	116,30











Piastra di Azionamento Skate
Air Cromo Grohe

CODICE	MISURA	UM	PZ	€
009 077 015	Grohe 38505000	PZ	1	114,90

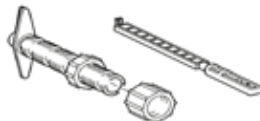

CODICE	MISURA	UM	PZ	€		
009 077 014	Grohe 38732SHO	PZ	1	69,80	Piastra di Azionamento Skate Cosmopolitan Bianco Grohe	
009 077 018	Grohe 38844SHO	PZ	1	82,10	Piastra di Azionamento Arena Cosmopolitan Bianco Grohe	
009 077 045	Grohe 38505SHO	PZ	1	65,70	Piastra di Azionamento Skate Air BIANCO Grohe	
009 077 021	Grohe 37059000 Cromata	PZ	0	361,20	Pulsante Azionamento Pneumatico Con Placca Cieca Grohe	
009 077 039	Grohe GD2 66275040	PZ	0	14,50	Dima di Montaggio per Cassetta Grohe	
009 077 044	Grohe 42533000	PZ	1	143,00	Valvola di Scarico Cassetta Dual Flush Grohe	
009 077 043	Grohe 37102000 - Cromato	PZ	1	118,70	Canotto Cromato Cassetta Dual Flusc Grohe	
009 077 005	Canotto Bianco per Cassetta Ghohe	PZ	1	20,60		
009 077 004	Grohe 370540SHO	PZ	1	75,00	Piastra di Azionamento Bianca Grohe	
009 077 023	Grohe 43821	PZ	1	10,40	Rubinetto Squadro per Cassetta	
009 077 031	Grohe 4376800M	PZ	1	2,40	O-Ring Dal Grohe	
009 077 035	Grohe 42310000	PZ	1	16,90	Guarnizione Cassetta Grohe	
009 077 028	Grohe 43917	PZ	1	47,90	Guarnizione Sfera Valvola Scarico	
009 077 025	Grohe 43722	PZ	1	33,70	Set Guarnizione Valvola Carico Dal	
009 077 022	Grohe 43733	PZ	1	19,40	Ricambio Cassetta Grohe Membrana Valvola Carico	
009 077 026	Grohe 43896	PZ	1	23,30	Ricambio Cassetta Grohe Leva per Valvola Carico	



	Traversa Azionamento Grohe	CODICE 009 077 029	MISURA Grohe 42962	UM PZ	PZ 1	€ 25,90
	Galleggiante Valvola Carico	CODICE 009 077 008	MISURA Grohe 37092	UM PZ	PZ 1	€ 87,60
	Valvola Scarico Dal	CODICE 009 077 042	MISURA Grohe 42961	UM PZ	PZ 1	€ 59,90
	Valvola di Scarico Cassetta AV1 Grohe	CODICE 009 077 046	MISURA Grohe 4232000	UM PZ	PZ 1	€ 143,00
	Limitatore di Flusso per Cassetta Grohe	CODICE 009 077 009	MISURA Grohe 111477	UM PZ	PZ 1	€ 40,30
	Azionamento Dal	CODICE 009 077 040	MISURA Grohe 43520	UM PZ	PZ 1	€ 31,10
	Piastra Dual Cassetta Grohe Bianca	CODICE 009 077 012	MISURA Grohe 37859	UM PZ	PZ 1	€ 84,30
	Piastra Dual Cassetta Grohe Cromata	CODICE 009 077 041	MISURA Grohe 3785900	UM PZ	PZ 1	€ 129,00
	Valvola Carico Cassetta Dual Grohe	CODICE 009 077 034	MISURA Grohe 43733000	UM PZ	PZ 1	€ 79,80
	Leva Completa Dal	CODICE 009 077 038	MISURA Grohe 43991	UM PZ	PZ 1	€ 19,40
	Ricambio Cassetta Grohe Dual Servo Set Supporto + Galleg.Dal	CODICE 009 077 003	MISURA Grohe 37078PI	UM PZ	PZ 1	€ 197,20



CODICE	MISURA	UM	PZ	€
009 078 001	Sigma8 109.790.00.1	PZ	1	295,40

Cassetta Incasso Geberit
Sigma8 Solo Cassetta



CODICE	MISURA	UM	PZ	€
009 078 002	Combifix 110.790.00.1	PZ	1	502,20

Cassetta Incasso Geberit
Combifix Italia Sigma8
per Wc Sopsesi



CODICE	MISURA	UM	PZ	€
009 078 006	AP116 136.432.11.1	PZ	1	113,10

Cassetta a Zaino Geberit
AP116 Doppio Scarico
Esterna



CODICE	MISURA	UM	PZ	€
009 078 010	Sigma01 Bianco 115.770.11.5	PZ	1	102,80

Placca Sigma01 Bianca
Cassetta Incasso Geberit
Doppio Tasto



CODICE	MISURA	UM	PZ	€
009 078 011	Sigma01 Cromata 115.770.21.5	PZ	1	169,10

Placca Sigma01 Cromata
Cassetta Incasso Geberit
Doppio Tasto



CODICE	MISURA	UM	PZ	€
009 078 020	Sigma su Unica 242.351.00.1	PZ	1	41,70

kit Addattamento Placca
per Cassetta Incasso
Sigma su Unica Geberit



CODICE	MISURA	UM	PZ	€
009 078 030	Geberit 118.221.11.1	PZ	1	34,90

Canotto Bianco Allacciamento
Cassetta Incasso Geberit















CODICE	MISURA	UM	PZ	€
009 078 035	Bonomini 8820AB40B0	PZ	1	9,10

Canotto Bianco Bonomini
Allacciamento Cassetta
Incasso Geberit



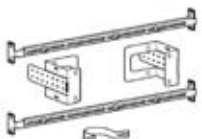

	Ricambi Geberit Rubinetto Galleggiante Tipo380 (Tipo Universale)	CODICE 009 078 040	MISURA Geberit 240.784.00.1	UM PZ	PZ 1	€ 86,60
	Ricambi Geberit Membrana per Rubinetto Galleggiante Tipo380	CODICE 009 078 041	MISURA Geberit 242.313.00.1	UM PZ	PZ 1	€ 4,40
	Ricambi Geberit Guarnizione Curva Sigma-Twiline-Unica	CODICE 009 078 045	MISURA Geberit 362.771.00.1	UM PZ	PZ 1	€ 2,50
	Ricambi Geberit Kit Guarnizione per Impulso 380 Unica	CODICE 009 078 046	MISURA Geberit 240.771.00.1	UM PZ	PZ 1	€ 20,30
	Ricambi Geberit Guarnizione Bacinella	CODICE 009 078 047	MISURA Geberit 894.082.00.1	UM PZ	PZ 1	€ 2,90
	Ricambi Geberit Bacinella con Guarnizione Twiline	CODICE 009 078 048	MISURA Geberit 240.282.00.1	UM PZ	PZ 1	€ 3,60
	Ricambi Geberit Supporto Twiline	CODICE 009 078 049	MISURA Geberit 240.500.00.1	UM PZ	PZ 1	€ 8,90
	Ricambi Geberit Campana Completa Twiline	CODICE 009 078 050	MISURA Geberit 240.511.00.1	UM PZ	PZ 1	€ 11,70
	Ricambi Geberit Campana Completa Twico Twiline	CODICE 009 078 055	MISURA Geberit 215.299.00.1	UM PZ	PZ 1	€ 32,20
	Ricambi Geberit Campana Twico Completa per Sigma	CODICE 009 078 056	MISURA Geberit 240.502.00.1	UM PZ	PZ 1	€ 46,60
	Ricambi Geberit Supporto Twico per Sigma8	CODICE 009 078 060	MISURA Geberit 241.290.00.1	UM PZ	PZ 1	€ 46,80
	Ricambi Geberit Kit per Struttura Leggera Sigma8	CODICE 009 078 065	MISURA Geberit 243.344.00.1	UM PZ	PZ 1	€ 18,90
	Ricambi Geberit Guarnizione per Campana Sigma8	CODICE 009 078 067	MISURA Geberit 243.272.00.1	UM PZ	PZ 1	€ 75,70
	Ricambi Geberit Guarnizione per Campana Sigma8	CODICE 009 078 070	MISURA Geberit 241.291.00.1 525x195	UM PZ	PZ 1	€ 7,20



CODICE	MISURA	UM	PZ	€
009 076 001	Pucci 1315490001 9 Lt-4Lt	PZ	1	195,10

Cassetta Incasso Pucci
Eco senza placca
con Canotto



CODICE	MISURA	UM	PZ	€
009 076 002	Pucci 1315490201 9 Lt-4Lt	PZ	1	219,00

Cassetta Incasso Pucci
Eco Anticondensa
senza placca con Canotto



CODICE	MISURA	UM	PZ	€
009 076 010	Pucci 80130550	PZ	1	43,70

Placca Cassetta Incasso
Pucci Eco Ellisse Bianca



CODICE	MISURA	UM	PZ	€
009 076 011	Pucci 80130552	PZ	1	82,80

Placca Cassetta Incasso
Pucci Eco Ellisse Cromata



CODICE	MISURA	UM	PZ	€
009 076 020	Pucci 80130560	PZ	1	43,70

Placca Cassetta Incasso
Pucci Eco Linea Bianca

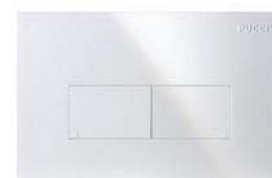

CODICE	MISURA	UM	PZ	€
009 076 021	Pucci 80130562	PZ	1	82,80

Placca Cassetta Incasso
Pucci Eco Linea Cromata





Cassetta a Zaino GEBERIT AP116 Doppio Scarico Esterna

CODICE	MISURA	UM	PZ	€
009 078 006	Geberit 136.432.11.1	PZ	1	113,10



Cassetta a Zaino Grohe 38372SHM Bianca Completa

CODICE	MISURA	UM	PZ	€
009 077 036	Grohe 38372SHM	PZ	1	123,10



Cassetta a Zaino Coibentata Oliver Gemma Funzione Start e Stop

CODICE	MISURA	UM	PZ	€
009 169 002	Oli 461501	PZ	1	46,10



Cassetta a Zaino Doppio Pulsante Oliver Smeraldo

CODICE	MISURA	UM	PZ	€
009 169 004	Oli 407501 3Lt e 6/9 Lt	PZ	1	69,90



Cassetta Zaino Doppio Pulsante Oliver Zaffiro Monoblocco

CODICE	MISURA	UM	PZ	€
009 169 005	Oli 425201 9/4,4-6/3 Lt	PZ	1	126,20



Valvola Con Pulsante Esterno Pneumatico Universale Scarico Bianco Oli

CODICE	MISURA	UM	PZ	€
009 169 015	Oli 500800	PZ	1	50,70



Cassetta a Zaino 1 Sciacquo Completa Canotto Negrari

CODICE	MISURA	UM	PZ	€
009 164 001	Negrari 1034	PZ	1	33,00



Cassetta a Zaino Pneumatica con Pulsante per Disabili Topazio

CODICE	MISURA	UM	PZ	€
009 164 020	Oli 411791	PZ	1	115,90



Cassetta Alta Senza Tubi

CODICE	MISURA	UM	PZ	€
009 164 002	Negrari 1041	PZ	1	33,10



CODICE	MISURA	UM	PZ	€
009 084 023	D.50x32 Normale	PZ	1	6,60
009 084 024	D.50x40 Normale	PZ	1	6,60
009 084 016	D.50x32x60 Prolungato	PZ	1	10,10

Tube per Cassetta a Zaino



CODICE	MISURA	UM	PZ	€
009 164 003	Galleggiante	PZ	1	10,50
009 164 004	Tasto con Leva Nova Ramo	PZ	1	2,50
009 164 005	Fungo per Nova Ramo	PZ	1	8,70
009 164 006	Piletta con Piramide per Nova Ramo	PZ	1	4,00
009 164 009	Dadoe Controdado per Nova Ramo	PZ	1	3,30
009 164 010	Guarnizione Conica per Nova Ramo	PZ	1	0,70

Accessori Cassetta Zaino



CODICE	MISURA	UM	PZ	€
001 164 008	Cod.1287000000	PZ	1	8,60

Galleggiante Universale
Compatto per Cassetta Zaino
ed Esterna



CODICE	MISURA	UM	PZ	€
009 084 015	Negrari 1500A D.32	PZ	1	9,50

Tubi Scarico Cassetta Alta
2 Pz



CODICE	MISURA	UM	PZ	€
009 169 001	Oli 600001+627001+602101	PZ	1	181,00

Cassetta Incasso Diamante
Evo Oliver Doppio Pulsante
C/Placca e can.



CODICE	MISURA	UM	PZ	€
009 169 010	Oli 600001	PZ	1	125,70

Cassetta Incasso Diamante
Evo Oliver Doppio Pulsante
Solo Cassetta



CODICE	MISURA	UM	PZ	€
009 169 011	Oli 627001	PZ	1	38,50

Placca Dual Diamante Evo
Bianco Doppio Pulsante



CODICE	MISURA	UM	PZ	€
009 169 012	Oli 602101	PZ	1	9,90

Canotto Cassetta Diamante
Evo Bianco





Box Doccia ad Angolo 2 Lati
Scorrevoli in Polistirene

CODICE	MISURA	UM	PZ	€
010 002 003	Cm 70/80 (68-78)	PZ	1	197,10
010 002 004	Cm 70-90 (68/78-78/88)	PZ	1	207,20
010 002 010	Cm 80-90 (78-88)	PZ	1	207,20



Parete Fissa
d'Accoppiamento
in Polistirene

CODICE	MISURA	UM	PZ	€
010 002 005	Cm 68-72	PZ	1	146,30
010 002 006	Cm 73-77	PZ	1	146,30
010 002 002	Cm 78-82	PZ	1	146,30
010 002 007	Cm 83-87	PZ	1	146,30
010 002 008	Cm 88-92	PZ	1	146,30



Box Doccia Semicircolare
2 Ante Scorrevoli
in Polistirene

CODICE	MISURA	UM	PZ	€
010 002 020	Cm 80-80	PZ	1	485,50
010 002 021	Cm 90-90	PZ	1	497,70



Box Doccia Soffietto
2 Ante Scorrevoli
Apertura 58 in Polistirene

CODICE	MISURA	UM	PZ	€
010 002 030	Cm 69-73	PZ	1	343,30
010 002 031	Cm 78-83	PZ	1	343,30
010 002 032	Cm 88-93	PZ	1	343,30



Box Vasca Parete
3 Pannelli Pieghevoli

CODICE	MISURA	UM	PZ	€
010 002 001	Cm 134 - H 140	PZ	1	193,00



CODICE	MISURA	UM	PZ	€
010 002 011	Cm 70-80 (68-78)	PZ	1	298,70
010 002 012	Cm 70-90 (68/78 - 78/88)	PZ	1	321,00
010 002 013	Cm 90-90 (79/90 - 79-90)	PZ	1	321,00

Box Doccia Angolo
2 Lati Cristallo 3 mm
Stampato C



SETTORE 010

IDRAULICA

CODICE	MISURA	UM	PZ	€
010 002 015	Cm 68-72	PZ	1	170,70
010 002 016	Cm 78-82	PZ	1	166,60

Box Doccia Parete Fissa
Cristallo 3 mm
Stampato C



CODICE	MISURA	UM	PZ	€
010 002 025	Cm 80-80	PZ	1	532,30
010 002 026	Cm 90-90	PZ	1	548,50

Box Doccia Semicircolare
Cristallo 3 mm
Stampato C



CODICE	MISURA	UM	PZ	€
010 002 040	Cm 68-73	PZ	1	355,50
010 002 041	Cm 78-83	PZ	1	371,80
010 002 042	Cm 88-93	PZ	1	371,80

Box Doccia Porta Soffietto
2 Ante Cristallo 3 mm
Stampato C





Lato Box Doccia
Cristallo 6 mm Trasparente
Tonga H190 Cromato

**N.B. per la composizione
dei box abbinare i singoli lati**

CODICE	MISURA	UM	PZ	€
010 002 050	Cm 68,5/71 - TA 70 T	PZ	1	303,90
010 002 051	Cm 72,5/75 - TA 75 T	PZ	1	303,90
010 002 052	Cm 77,5/80 - TA 80 T	PZ	1	327,50
010 002 053	Cm 87,5/90 - TA 90 T	PZ	1	346,70
010 002 054	Cm 97,5/100 - TA 100 T	PZ	1	374,80
010 002 055	Cm 117,5/120 - TA 120 T	PZ	1	405,20



Box Doccia
Cristallo 6 mm Trasparente
Tonga H190 Semicircolare
Cromato

CODICE	MISURA	UM	PZ	€
010 002 060	Cm 77,5/80 TS04 T	PZ	1	724,80
010 002 061	Cm 87,5/90 TS05 T	PZ	1	747,30



Lato Box Doccia
Cristallo 6mm Trasparente
Tonga H190
Porta Scorrevole

**N.B. per la composizione
dei box abbinare i singoli lati**

CODICE	MISURA	UM	PZ	€
010 002 070	Cm 97/102 TPS06 T	PZ	1	545,90
010 002 071	Cm 117/122 TPS07 T	PZ	1	563,90
010 002 069	Cm 127/132 TPS08 T	PZ	1	616,80
010 002 072	Cm 137/142 TPS09 T	PZ	1	628,00
010 002 073	Cm 147/152 TPS15 T	PZ	1	793,50
010 002 074	Cm 157/162 TPS17 T	PZ	1	913,90
010 002 075	Cm 167/172 TPS19 T	PZ	1	969,00
010 002 076	Cm 167/182 TPS21 T	PZ	1	969,00



Lato Box Doccia
Cristallo 6 mm Trasparente
Tonga H190
Parete Fissa

**N.B. per la composizione
dei box abbinare i singoli lati**

CODICE	MISURA	UM	PZ	€
010 002 080	Cm 67/71 TF03 T	PZ	1	356,80
010 002 081	Cm 76/81 TF05 T	PZ	1	356,80
010 002 082	Cm 86/91 TF07 T	PZ	1	398,40
010 002 083	Cm 71/76 TF04 T	PZ	1	388,30



Ricambi per Box
Antina Liscia
Gruppo di Scorrimento

CODICE	MISURA	UM	PZ	€
010 002 085	Superiore	PZ	1	20,40
010 002 086	Inferiore	PZ	1	20,40



Ricambi per Box
Semi Circolare
Gruppo di Scorrimento

CODICE	MISURA	UM	PZ	€
010 002 087	Inferiore	PZ	1	17,10
010 002 088	Superiore	PZ	1	17,10



CODICE	MISURA	UM	PZ	€
010 002 090	Cm 68,5/71 - TA 70 C	PZ	1	303,90
010 002 091	Cm 72,5/75 - TA 75 C	PZ	1	303,90
010 002 092	Cm 77,5/80 - TA 80 C	PZ	1	327,50
010 002 093	Cm 87,5/90 - TA 90 C	PZ	1	346,70
010 002 094	Cm 97,5/100 - TA 100 C	PZ	1	374,80
010 00 2095	Cm 117,5/120 - TA 120 C	PZ	1	405,20

Lato Box Doccia
Cristallo 6 mm Stampato C
Tonga H190
Cromato TA



**N.B. per la composizione
dei box abbinare i singoli lati**

CODICE	MISURA	UM	PZ	€
010 002 060	Cm 77,5/80 TS04 C	PZ	1	724,80
010 002 101	Cm 87,5/90 TS05 C	PZ	1	747,30

Box Doccia
Cristallo 6 mm Stampato C
Tonga H190 Semicircolare
Cromato TS



CODICE	MISURA	UM	PZ	€
010 002 110	Cm 97/102 TPS06 C	PZ	1	545,90
010 002 111	Cm 117/122 TPS07 C	PZ	1	563,90
010 002 099	Cm 127/132 TPS08 C	PZ	1	616,80
010 002 112	Cm 137/142 TPS09 C	PZ	1	628,00
010 002 113	Cm 147/152 TPS15 C	PZ	1	793,50
010 002 114	Cm 157/162 TPS17 C	PZ	1	913,90
010 002 115	Cm 167/172 TPS19 C	PZ	1	969,00
010 002 116	Cm 167/182 TPS21 C	PZ	1	969,00

Box Doccia
Cristallo 6mm Stampato C
Tonga H190
Porta Scorrevole SC



CODICE	MISURA	UM	PZ	€
010 002 120	Cm 67/71 TF03 C	PZ	1	356,80
010 002 121	Cm 76/81 TF05 C	PZ	1	356,80
010 002 122	Cm 86/91 TF07 C	PZ	1	366,90
010 002 123	Cm 71/76 TF04 C	PZ	1	356,80

Box Doccia
Cristallo 6 mm Stampato C
Tonga H190
Parete Fissa TF





Box Doccia in Pvc
a Soffietto H185
Angolo 2 Lati Plus

CODICE	MISURA	UM	PZ	€
010 173 021	Cm 80-60	PZ	1	280,40
010 173 032	Cm 80-100	PZ	1	301,30
010 173 033	Cm 80-120	PZ	1	334,00
010 173 022	Cm 75-90	PZ	1	297,40



Box Doccia Acrilico
Skipper H185
Antina Scorrevole
2 Lati

CODICE	MISURA	UM	PZ	€
010 173 040	Cm 70x70	PZ	1	197,20
010 173 041	Cm 80x80	PZ	1	177,40



Box Doccia in Pvc
a Soffietto H188
Mono 1 Lato Plus

CODICE	MISURA	UM	PZ	€
010 173 023	Cm 80 -100	PZ	1	220,60
010 173 024	Cm 100-140	PZ	1	257,20
010 173 035	Cm 180-160	PZ	1	308,40



Box Doccia Acrilico
Skipper H185
parete Fissa
1 Lato

CODICE	MISURA	UM	PZ	€
010 173 043	Cm 68-72	PZ	1	166,60



Box Doccia in Pvc
a Soffietto H185
Angolo
3 Lati Plus

CODICE	MISURA	UM	PZ	€
010 173 025	Cm 80 -90 -80	PZ	1	458,30
010 173 026	Cm 100-100-100	PZ	1	499,90



CODICE	MISURA	UM	PZ	€
010 173 020	Cm 70-90x70-90	PZ	1	390,10

Box Doccia in Pvc
a Soffietto H185
Semicircolare Sfera Plus



CODICE	MISURA	UM	PZ	€
010 173 031	Cm 70-90	PZ	1	403,50

Box Doccia in Pvc
a Soffietto H185 Angolo
Asimmetrico Plus



CODICE	MISURA	UM	PZ	€
010 174 001	Cm 60-80 x60-80	PZ	1	169,70
010 174 006	Cm 80-100x80-100	PZ	1	240,20
010 174 007	Cm 75-90 x75-90	PZ	1	228,80

Box Doccia in Pvc
a Soffietto H185
Angolo 2 Lati Eco



CODICE	MISURA	UM	PZ	€
010 174 010	Cm 60 -80	PZ	1	157,00
010 174 011	Cm 80 -100	PZ	1	172,50
010 174 012	Cm 100-160	PZ	1	205,00

Box Doccia in Pvc
a Soffietto H185
Mono 1 Lato Eco



CODICE	MISURA	UM	PZ	€
010 173 027	Cm 140-170	PZ	1	292,80

Box Vasca in Pvc
a Soffietto H150
Mono 1 Lato Plus Sirio



CODICE	MISURA	UM	PZ	€
010 173 028	Cm 170-70	PZ	1	392,50

Box Vasca in Pvc
a Soffietto H150
Angolo 2 Lati Plus Kappa



CODICE	MISURA	UM	PZ	€
010 173 029	Cm 70-170-70	PZ	1	484,50

Box Vasca in Pvc
a Soffietto H150
Angolo 3 Lati Plus





	Gruppo a Parete per Vasca Completo di Doccetta Ottone Pesante	CODICE	MISURA	UM	PZ	€
		011 003 001	D.1"	PZ	1	123,60
	Batteria Lavabo 3 Fori con Scarico 1" Rubinetteria Tradizionale	CODICE	MISURA	UM	PZ	€
		011 003 002	D.1"	PZ	1	123,60
	Batteria Bidet 3 Fori con Scarico 1" Rubinetteria Tradizionale	CODICE	MISURA	UM	PZ	€
		011 003 003	D.1"	PZ	1	81,10
	Rubinetto Incasso Femmina Femmina a Pomello	CODICE	MISURA	UM	PZ	€
		011 003 004	D.1/2	PZ	1	28,50
	Rubinetto Incasso Con Cappuccio Femmina Femmina a Pomello	CODICE	MISURA	UM	PZ	€
		006 100 036	D.1/2	PZ	1	22,90
	Rubinetto Lavatrice Doppio Uso Pesante	CODICE	MISURA	UM	PZ	€
		011 003 037	D.1/2	PZ	1	26,00
	Rubinetto Collo Cigno	CODICE	MISURA	UM	PZ	€
		011 003 007	D.1/2	PZ	1	34,00
	Fissaggi Monoforo	CODICE	MISURA	UM	PZ	€
		011 003 015	Due Vite	PZ	1	1,10
		011 003 016	1 Vite	PZ	1	1,00
	Canna Monoforo Inferiore Lavello	CODICE	MISURA	UM	PZ	€
		011 006 009	D.3/4x18x200	PZ	1	14,90
	Canna Diritta per Miscelatore Parete Cromato	CODICE	MISURA	UM	PZ	€
		011 006 003	mm 200	PZ	1	13,50
		011 006 004	mm 250	PZ	1	15,30
	Canna Lavello Superiore a Parete Tradizionale Cromato	CODICE	MISURA	UM	PZ	€
		011 006 011	D.3/4x18x20	PZ	1	15,00
	Canna Miscelatore Lavello Collo Cigno Cromato	CODICE	MISURA	UM	PZ	€
		011 006 005	Idro 1267000106	PZ	1	17,80
	Canna Monoforo Lavello	CODICE	MISURA	UM	PZ	€
		011 006 008	D.3/4	PZ	1	12,90



CODICE	MISURA	UM	PZ	€
011 003 008	D.1/2	PZ	1	63,70

Rubinetto Gruppo Parete
Canna Inferiore



CODICE	MISURA	UM	PZ	€
011 003 009	D.1/2	PZ	1	63,70

Rubinetto Gruppo Parete
Canna Superiore



CODICE	MISURA	UM	PZ	€
011 006 006	D.1/2	PZ	1	86,90

Rubinetto Gruppo Parete
Canna Inferiore
Attacco Lavatrice



CODICE	MISURA	UM	PZ	€
011 003 010	D.1/2	PZ	1	35,40

Rubinetto Lavello a Parete
Canna Inferiore Pesante



CODICE	MISURA	UM	PZ	€
011 006 018	D.1/2	PZ	1	48,30

Rubinetto Lavello
Solo Freddo Pesante



CODICE	MISURA	UM	PZ	€
011 003 033	D.1/2	PZ	1	35,40

Rubinetto Lavello a Parete
Canna Superiore Pesante



CODICE	MISURA	UM	PZ	€
011 006 041	D.1/2	PZ	1	34,00

Rubinetto Snodo a Parete
Canna Inferiore
Attacco Lavatrice Leggero



CODICE	MISURA	UM	PZ	€
011 006 042	D.1/2	PZ	1	47,00

Rubinetto Snodo a Parete
Canna Inferiore
Attacco Lavatrice Pesante



CODICE	MISURA	UM	PZ	€
011 006 007	D.1/2	PZ	1	59,90

Rubinetto Lavello
Gruppo Monoforo
Pesante



CODICE	MISURA	UM	PZ	€
011 006 039	D.1/2	PZ	1	86,00

Rubinetto Lavello
Gruppo Monoforo
Canna Fusa Pesante



CODICE	MISURA	UM	PZ	€
011 006 013	D.1/2	PZ	1	56,00

Rubinetto Monoforo
Lavello Parete Sotto Boiler
Senza Cannuce





Vitone per Gruppo a Parete
Ottone

CODICE	MISURA	UM	PZ	€
011 003 035	D.1/2 8x20	PZ	10	8,40



Vitone per Rubinetto
Passo Rapido

CODICE	MISURA	UM	PZ	€
011 003 029	D.1/2 Destro	PZ	10	14,20
011 003 039	D.1/2 Sinistro	PZ	10	14,20



Vitone per Rubinetto
Monoforo Lavello
Ottone Bagno d'Olio

CODICE	MISURA	UM	PZ	€
011 003 032	D.3/8 8x24	PZ	10	4,30



Vitone Ceramico
1/4 di Giro

CODICE	MISURA	UM	PZ	€
011 003 030	D.1/2 Destro	PZ	10	16,70
011 003 038	D.1/2 Sinistro	PZ	10	16,70



Vitone per Rubinetto
ad Incasso Ottone 8x20

CODICE	MISURA	UM	PZ	€
011 003 031	D.1/2	PZ	10	10,90



Vitone Blister
Kit Pronto Intervento

CODICE	MISURA	UM	PZ	€
011 006 020		PZ	1	23,90



Miscelatore Lavabo
con Leva Clinica

CODICE	MISURA	UM	PZ	€
011 129 042	Gaboli 5020LEVA4	PZ	1	103,30



Miscelatore Lavello
Monoforo con Leva Clinica

CODICE	MISURA	UM	PZ	€
011 129 049	Gaboli 5160LEVA	PZ	1	94,60



Miscelatore Lavello
a Parete
con Leva Clinica

CODICE	MISURA	UM	PZ	€
011 003 028	D. 1/2	PZ	1	94,00



Miscelatore Lavabo
Collo Cigno
con Leva Clinica

CODICE	MISURA	UM	PZ	€
011 166 009	D.1/2 - Idro 02050/DC	PZ	1	107,40



Rubinetto Lavabo
Parete con Leva Clinica

CODICE	MISURA	UM	PZ	€
011 166 010	D.1/2	PZ	1	77,70



Leva Clinica
per Miscelatori

CODICE	MISURA	UM	PZ	€
011 180 061	Idro G200LEVA CL	PZ	1	9,80



CODICE	MISURA	UM	PZ	€
011 129 050	Idro P106CR0000	PZ	1	60,90

Miscelatore Monoforo
Lavello Canna Alta Tipo C
Prince



CODICE	MISURA	UM	PZ	€
011 129 035	Idro P107CR0000	PZ	1	50,00

Miscelatore Monoforo
Lavello Canna Bassa Tipo C
Prince



CODICE	MISURA	UM	PZ	€
011 129 005	Gaboli 5120GABOLI	PZ	1	87,30

Miscelatore Monoforo
Lavello Canna Alta Ponte
Gaboli



CODICE	MISURA	UM	PZ	€
011 129 051	D.1"1/4 - Idro P100CR00GB	PZ	1	52,80

Miscelatore Lavabo Tipo C
Scarico Cartuccia D.40
Prince



CODICE	MISURA	UM	PZ	€
011 129 052	D. 1"1/4 - Idro P101CR00GB	PZ	1	52,80

Miscelatore Bidet Tipo C
Scarico Cartuccia D.40
Prince



CODICE	MISURA	UM	PZ	€
011 129 053	D.1/2	PZ	1	67,30

Miscelatore Vasca Esterno
con Duplex Tipo C
Cartuccia D.40 Prince



CODICE	MISURA	UM	PZ	€
011 129 054	D.1/2	PZ	1	40,40

Miscelatore Doccia
Incasso Tipo C
Cartuccia D.40 Prince



CODICE	MISURA	UM	PZ	€
011 129 009	D.1/2	PZ	1	52,10

Miscelatore Doccia
Esterno Tipo C
Cartuccia D.40 Prince



CODICE	MISURA	UM	PZ	€
011 129 055	D.1/2	PZ	1	56,70

Miscelatore Lavello
Parete Canna Inferiore Tipo C
D.40 Prince



CODICE	MISURA	UM	PZ	€
011 180 018	D.1/2	PZ	1	84,50

Miscelatore Lavello
Monoforo Doccetta Estraibile
Tipo C Prince



CODICE	MISURA	UM	PZ	€
011 129 008	D.40 - Universale Tipo c Prince	PZ	1	3,70

Cartuccia Miscelatore
Universale Tipo c



011 129 007	D.35 - Universale Tipo c Prince	PZ	1	4,10
011 129 011	D.40 - Tipo C Universale Alta	PZ	1	4,10
011 129 012	D.35 - Tipo C Universale Alta	PZ	1	4,10



Miscelatore Termostatico Esterno

CODICE	MISURA	UM	PZ	€
011 166 001	D.3/4	PZ	1	120,90



Miscelatore Termostatico Per Doccia da Incasso

CODICE	MISURA	UM	PZ	€
011 166 014	D.1/2	PZ	1	323,40



Miscelatore Termostatico Per Doccia Esterno

CODICE	MISURA	UM	PZ	€
011 166 015	D.1/2	PZ	1	250,00



Rubinetto a Pedale Solo Freddo

CODICE	MISURA	UM	PZ	€
011 166 004	D.1/2	PZ	1	185,10



Rubinetto a Pedale Caldo Freddo

CODICE	MISURA	UM	PZ	€
011 166 005	D.1/2	PZ	1	278,70



Bocca di Erogazione Girevole a Parete

CODICE	MISURA	UM	PZ	€
011 166 011	D.1/2	PZ	1	23,20



Bocca di Erogazione Girevole su Lavabo

CODICE	MISURA	UM	PZ	€
011 166 012	D.1/2	PZ	1	57,20



Rubinetto a Pulsante Temporizzato Lavabo

CODICE	MISURA	UM	PZ	€
011 166 016	D.1/2	PZ	1	89,10



Rubinetto a Pulsante Temporizzato a Parete

CODICE	MISURA	UM	PZ	€
011 166 017	D.1/2	PZ	1	69,40



Rubinetto a Pulsante Ottone Giallo a Parete

CODICE	MISURA	UM	PZ	€
001 091 030	D.1/2	PZ	1	50,30



CODICE	MISURA	UM	PZ	€
011 166 018	Cm 30	PZ	1	46,60
011 166 023	Cm 50	PZ	1	53,60
011 166 020	Cm 60	PZ	1	56,20

Maniglione Dritto
Bianco



CODICE	MISURA	UM	PZ	€
011 166 022	Cm 60 D.32 mm	PZ	1	66,70
011 166 042	Cm 50 D.32 mm	PZ	1	63,60
011 166 041	Cm 40 D.32 mm	PZ	1	58,10
011 166 040	Cm 30 D.32 mm	PZ	1	54,90

Maniglione Dritto
Acciaio Inox



CODICE	MISURA	UM	PZ	€
011 166 025	Cm 22x22 D.32 mm	PZ	1	45,30

Maniglione a Muro
ad Angolo 30° Bianco



CODICE	MISURA	UM	PZ	€
011 166 024	Cm 30x30 D.32 mm	PZ	1	43,00

Maniglione a Muro
ad Angolo 90° Bianco



CODICE	MISURA	UM	PZ	€
011 166 019	Cm 60 D.28 mm	PZ	1	119,30

Maniglione a Muro
Barra Ribaltabile Bianco



CODICE	MISURA	UM	PZ	€
011 166 037	L450xH600	PZ	1	244,30

Specchio Reclinabile
per Lavabo Ergonomico



CODICE	MISURA	UM	PZ	€
011 166 021	Cm37x28 Portata Kg 110	PZ	1	105,60

Sedile Ribaltabile
per Doccia Moplen



CODICE	MISURA	UM	PZ	€
011 166 026	Cm37x28 Est.65x70 H16 Port. Kg 110	PZ	1	92,10

Sedile per Vasca
da Bagno Moplen



CODICE	MISURA	UM	PZ	€
011 166 030	Verniciato	PZ	1	164,30

Meccanismo di Inclinazione
Manuale per Lavabo Disabili
Verniciato



CODICE	MISURA	UM	PZ	€
011 166 031	Verniciato	PZ	1	252,70

Meccanismo di Inclinazione
Pneumatico per Lavabo
Disabili Verniciato



CODICE	MISURA	UM	PZ	€
011 166 036	L 145 x H 355	PZ	1	61,80

Mensole Fisse
per Lavabo Ergonomico





Miscelatore Lavabo
Cromo Serie Pedro Gaboli

CODICE	MISURA	UM	PZ	€
011 129 031	Scarico 1"1/4 Cartuccia D.35 mm	PZ	1	87,70



Miscelatore Bidet
Cromo Serie Pedro Gaboli

CODICE	MISURA	UM	PZ	€
011 129 032	Scarico 1"1/4 Cartuccia D.35 mm	PZ	1	85,00



Miscelatore Vasca Esterno
Cromo Serie Pedro Gaboli

CODICE	MISURA	UM	PZ	€
011 129 033	D.1/2 con Duplex Doccia	PZ	1	104,30



Miscelatore Lavello Monoforo
Cromo Serie Pedro Gaboli

CODICE	MISURA	UM	PZ	€
011 129 038	D.1/2 Cartuccia D.35 mm	PZ	1	91,50



Miscelatore Doccia Esterno
Cromo Serie Pedro Gaboli

CODICE	MISURA	UM	PZ	€
011 129 037	D.1/2 Cartuccia D.35 mm	PZ	1	71,50



Miscelatore Lavello Lavabo
Sotto Boiler

CODICE	MISURA	UM	PZ	€
011 129 040	D.1/2 Gaboli 119MIX	PZ	1	78,60



Miscelatore Doccia Incasso
Cromo Serie Pedro Gaboli

CODICE	MISURA	UM	PZ	€
011 129 034	D.1/2 Cartuccia D.35 mm	PZ	1	54,10



Miscelatore Vasca/Doccia
Incasso Con Deviatore Cromo
Pedro Gaboli

CODICE	MISURA	UM	PZ	€
011 180 006	D.1/2 Cart.35	PZ	1	146,70



Miscelatore Lavello Monoforo
Doccetta Estraibile Cromo

CODICE	MISURA	UM	PZ	€
011 180 019	Gaboli	PZ	1	157,50



Miscelatore Lavello Parete
Canna Inferiore Cromo
Serie Pedro

CODICE	MISURA	UM	PZ	€
011 129 036	Gaboli Cartuccia D.35 mm	PZ	1	94,60



Cartuccia Kerox
per Miscelatore

CODICE	MISURA	UM	PZ	€
011 129 019	D.40 Con Distributore	PZ	1	27,60
011 129 021	D.35 Con Distributore	PZ	1	28,30



Cartuccia Kerox
per Miscelatore

CODICE	MISURA	UM	PZ	€
011 129 020	D.40 Senza Distributore	PZ	1	26,30
011 129 022	D.35 Senza Distributore	PZ	1	27,40



CODICE	MISURA	UM	PZ	€
011 129 060	Scarico 1"1/4	PZ	1	103,60

Miscelatore Lavabo
Cromo Serie Noah
Gaboli



CODICE	MISURA	UM	PZ	€
011 129 061	Scarico 1"1/4	PZ	1	126,00

Miscelatore Lavabo
Allungato Cromo Serie Noah
Gaboli



CODICE	MISURA	UM	PZ	€
011 129 062	Scarico 1"1/4	PZ	1	105,70

Miscelatore Bidet
Cromo Serie Noah
Gaboli



CODICE	MISURA	UM	PZ	€
011 129 063	D. 1/2	PZ	1	174,70

Miscelatore Vasca Esterno
Cromo Serie Noah Gaboli
con Duplex Doccia



CODICE	MISURA	UM	PZ	€
011 129 064	D.1/2	PZ	1	77,20

Miscelatore Doccia
Incasso Serie Noah
Gaboli



CODICE	MISURA	UM	PZ	€
011 129 065	D. 1/2	PZ	1	162,60

Miscelatore Vasca Doccia
Incasso Con Deviatore
Cromo Noah
Gaboli



CODICE	MISURA	UM	PZ	€
011 129 066	Gaboli D.1/2	PZ	1	97,60

Miscelatore Doccia
Esterno Cromo Serie Noah
Gaboli



CODICE	MISURA	UM	PZ	€
011 129 067	D. 1/2	PZ	1	142,20

Miscelatore Lavello
Monoforo Cromo
Serie Noah
Gaboli



CODICE	MISURA	UM	PZ	€
011 129 068	D. 1/2	PZ	1	100,40

Miscelatore Lavello Parete
Canna Inferiore Cromo
Serie Noah
Gaboli





Miscelatore Lavabo
Cromo Hansa Pico

CODICE	MISURA	UM	PZ	€
011 061 200	Scarico D.1/4	PZ	1	136,30



Miscelatore Bidet
Cromo Hansa Pico

CODICE	MISURA	UM	PZ	€
011 061 201	Scarico D.1/4	PZ	1	150,50



Miscelatore Vasca Esterno
Con Duplex Doccia
Cromo Hansa Pico

CODICE	MISURA	UM	PZ	€
011 061 202	D.1/2	PZ	1	225,80



Miscelatore Doccia Esterno
Cromo Hansa Pico

CODICE	MISURA	UM	PZ	€
011 061 205	D.1/2	PZ	1	139,20



Miscelatore Doccia Incasso
Cromo Hansa Pico

CODICE	MISURA	UM	PZ	€
011 061 210	D.1/2	PZ	1	202,20



Miscelatore Termostatico
Sistema Asta Doccia Hansa
Serie Hunita

CODICE	MISURA	UM	PZ	€
011 061 215	D.1/2	PZ	1	353,10



Saliscendi Hansabasic 3Jet
Asta Doccia
con Porta Sapone

CODICE	MISURA	UM	PZ	€
011 061 158	D.1/2 Hansa 44780130	PZ	1	97,60



Cartuccia Hansa
per Miscelatori Eco 59

CODICE	MISURA	UM	PZ	€
011 061 218	Eco 59 912324 D.35 mm	PZ	1	68,00



CODICE	MISURA	UM	PZ	€
011 055 052	D.1/2 Sc.1"1/4 33265002	PZ	1	126,40

Miscelatore Monocomando
Lavabo Eurosmart
Grohe



CODICE	MISURA	UM	PZ	€
011 055 053	D.1/2 Sc.1"1/4 32929002	PZ	1	126,40
011 055 061	D.1/2 Sc.1"1/4 Eurostyle (ad Esaurimento)	PZ	1	175,50

Miscelatore Monocomando
Bidet Eurosmart
Grohe



CODICE	MISURA	UM	PZ	€
011 055 054	D.1/2 33556002	PZ	1	126,40

Miscelatore Monocomando
Doccia Incasso Eurosmart
Grohe



CODICE	MISURA	UM	PZ	€
011 055 055	D.1/2 33302002	PZ	1	183,90
011 055 063	D.1/2 Eurostyle (ad Esaurimento)	PZ	1	258,60

Miscelatore Monocomando
Vasca Esterno Eurosmart
Grohe



CODICE	MISURA	UM	PZ	€
011 055 056	D.1/2 33555002	PZ	1	126,40
011 055 064	D.1/2 (Eurostyle (ad Esaurimen- to))	PZ	1	205,20

Miscelatore Monocomando
Doccia Esterno Eurosmart
Grohe



CODICE	MISURA	UM	PZ	€
011 055 022	D.3/8x420 mm Grohe 4866000	PZ	1	16,90

Flessibile per Miscelatore
Grohe



CODICE	MISURA	UM	PZ	€
011 055 009	D.1/2 - Grohe 33202002	PZ	1	162,00

Miscelatore Lavello
Monofocro Cromo
Grohe Eurostyle



CODICE	MISURA	UM	PZ	€
011 055 016	Dischi Ceramici D.46 mm Grohe 46048000	PZ	1	121,60
011 055 021	Dischi Ceramici D.35 mm Grohe 46374000	PZ	1	126,70

Cartuccia Grohe
Universale per Miscelatori



CODICE	MISURA	UM	PZ	€
011 055 017	D.1/2 Cod.07146 Grohe 07146000	PZ	1	44,00

Vitone Grohe





Miscelatore Monocomando
Lavabo Base
Ceramica Dolomite

CODICE	MISURA	UM	PZ	€
011 033 001	Scarico D.1" 1/4 B5112AA	PZ	1	125,70



Miscelatore Monocomando
Bidet Base
Ceramica Dolomite

CODICE	MISURA	UM	PZ	€
011 033 002	Scarico D.1" 1/4 B5115AA	PZ	1	125,70



Miscelatore Monocomando
Vasca Esterno Base
Ceramica Dolomite

CODICE	MISURA	UM	PZ	€
011 033 003	D.1/2	PZ	1	173,50



Miscelatore Monocomando
Doccia Incass.Base
Ceramica Dolomite

CODICE	MISURA	UM	PZ	€
011 033 004	D.1/2 B6726AA	PZ	1	93,40



Miscelatore Monocomando
Doccia Estern.Base
Ceramica Dolomite

CODICE	MISURA	UM	PZ	€
011 033 005	D.1/2 B5116AA	PZ	1	125,70



Saliscendi Asta Doccia M3
mart Idealrain
Ideal Standard

CODICE	MISURA	UM	PZ	€
011 033 009	H. 724 mm B9508AA	PZ	1	110,90



CODICE	MISURA	UM	PZ	€
013 024 003	Cm 180 x 200 Bianca	PZ	1	13,90
013 024 014	Cm 180 x 200 Colorata	PZ	1	13,90

Tenda Doccia Pvc



CODICE	MISURA	UM	PZ	€
013 024 004	Cm 240 x 200 Bianca	PZ	1	17,30
013 024 015	Cm 240 x 200 Colorata	PZ	1	17,30

Tenda Vasca Pvc



CODICE	MISURA	UM	PZ	€
013 024 007	Cm 80 x 80 Bianco - 2 Lati	PZ	1	19,00
013 024 008	Cm 70 x 84 x 79 Bianco - 3 Lati	PZ	1	22,50

Telaio per Doccia



CODICE	MISURA	UM	PZ	€
013 024 010	Cm 79 x 167 Bianco - 2 Lati	PZ	1	22,50
013 024 009	Cm 70 x 167 x 79 Bianco - 3 Lati	PZ	1	27,70

Telaio per Vasca



CODICE	MISURA	UM	PZ	€
013 024 005	Cm 60 x 90 Diritto Bianco	PZ	1	17,50
013 024 006	Cm 70 x 115 Diritto Bianco	PZ	1	12,10

Telaio per Doccia o Vasca Estensibile 1 Lato



CODICE	MISURA	UM	PZ	€
013 024 011	Cm 55 x 53 Bianco	PZ	1	20,20
013 024 013	Cm 34 x 73 Bianco	PZ	1	20,20

Tappeto in Gomma per Doccia o Vasca Pvc



CODICE	MISURA	UM	PZ	€
013 024 016	Cm 60 x 60	PZ	1	20,20

Pedana per Doccia in Plastica



CODICE	MISURA	UM	PZ	€
013 024 012	Cm 60 x 60	PZ	1	55,30

Pedana per Doccia in Legno





Saliscendi Doccia Eden
Cromata Anticalacre
3 Jet Isa

CODICE	MISURA	UM	PZ	€
013 042 019	Cm 80 x 25 mm Eden	PZ	5	111,80



Saliscendi Doccia Urban
Cromata C/Porta sapone
Anticalacre 3 Jet Venus

CODICE	MISURA	UM	PZ	€
013 042 010	Cm 62 x 25 mm Urban	PZ	5	69,10



Completo Doccetta Cromata
con Duplex con Flex

CODICE	MISURA	UM	PZ	€
013 042 003	Cm 150 Pesante	PZ	10	31,90



Doccetta per Duplex
Doccia Cromata

CODICE	MISURA	UM	PZ	€
013 042 011	D.1/2 Zama Pesante	PZ	10	6,10



Curvetta Doccetta
per Duplex Cromata

CODICE	MISURA	UM	PZ	€
013 042 023	D.1/2 Zama	PZ	10	4,10



Doccetta Cromata
Con Anticalcare
tre Jet

CODICE	MISURA	UM	PZ	€
013 042 035	D.1/2	PZ	10	7,20



Doccetta Diritta
Cromata Con Anticalcare
Mono Jet

CODICE	MISURA	UM	PZ	€
013 042 022	D.1/2	PZ	10	2,80



Doccetta Diritta Lavello
Estraibile

CODICE	MISURA	UM	PZ	€
013 042 037	D.1/2 Gaboli	PZ	10	29,70
013 042 039	D.1/2 Idro	PZ	10	8,20



CODICE	MISURA	UM	PZ	€
013 042 013	D.1/2	PZ	10	101,50

Braccio Doccia Anticalcare
Pesante C/Soffione



CODICE	MISURA	UM	PZ	€
013 042 033	D.1/2	PZ	10	63,20

Braccio Doccia Anticalcare
Medio Con Soffione



CODICE	MISURA	UM	PZ	€
013 042 032	D. 1/2	Pz	1	130,10

Deviatore di Flusso
con Niples per Braccio
Doccia Magic Flex



CODICE	MISURA	UM	PZ	€
013 042 009	D.1/2 CM 18 X 20	PZ	10	10,40
013 042 045	D.1/2 CM 18 X 25	PZ	10	10,90
013 042 036	D.1/2 CM 18 X 30	PZ	10	10,70

Braccio Doccia
Tondo Cromato



CODICE	MISURA	UM	PZ	€
013 162 030	D.1/2 Cm 21	PZ	1	35,60

Soffione Doccia Tondo Cromo
Anticalcare Universe



CODICE	MISURA	UM	PZ	€
013 162 029	D.1/2	PZ	1	6,80

Soffione Doccia
Tondo Cromo Standard



CODICE	MISURA	UM	PZ	€
013 162 032	D.1/2 Cm 20 x 20	PZ	1	65,20

Soffione Doccia
Quadro Cromo Anticalcare
Zenith Inox Spazzolato



CODICE	MISURA	UM	PZ	€
013 042 034	Idro KINGDEV000	PZ	1	11,40

Deviatore Doccia
Braccio Colonna Cromato
King Idro



CODICE	MISURA	UM	PZ	€
013 162 037	D.1/2 Cm 20	PZ	1	27,40

Braccio Doccia
Tondo Cromato Pesante





Flessibile Doccia Ottone Cromato Doppia Agraffatura Conico Femmina

CODICE	MISURA	UM	PZ	€
013 042 014	D.1/2 x 1/2 x Cm 150	PZ	10	10,60
013 042 020	D.1/2 x 1/2 x Cm 200	PZ	10	13,30



Flessibile Doccia Spiroflex Pastificato Femmina Femmina

CODICE	MISURA	UM	PZ	€
013 042 025	D.1/2 x 1/2 x Cm 150	PZ	10	7,90
013 042 026	D.1/2 x 1/2 x Cm 200	PZ	10	9,20



Flessibile Doccia Femmina Conico

CODICE	MISURA	UM	PZ	€
013 042 021	D.1/2 x 1/2 x Cm 150	PZ	10	7,80
013 042 016	D.1/2 x 1/2 x Cm 200	PZ	10	9,80



Flessibile Doccia Normale Femmina Femmina

CODICE	MISURA	UM	PZ	€
013 042 043	D.1/2 x 1/2 x Cm 100	PZ	10	9,80
013 042 007	D.1/2 x 1/2 x Cm 150	PZ	10	12,60
013 042 002	D.1/2 x 1/2 x Cm 200	PZ	10	15,90



Flessibile Doccia Conico Pvc Argento Femmina Femmina

CODICE	MISURA	UM	PZ	€
013 042 028	D.1/2x1/2 Cm 150 Magic Flex	PZ	10	20,20



Flessibile Doccia Conico Acciaio Femmina Femmina

CODICE	MISURA	UM	PZ	€
013 042 030	D.1/2x1/2 Cm 150 Magic Flex	PZ	10	32,90



Flessibile Doccia Femmina Conico Oro

CODICE	MISURA	UM	PZ	€
013 042 040	D.1/2 x 1/2 x Cm 150	PZ	1	52,50



Flessibile Doccia Normale Maschio Femmina per Doccetta estraibile

CODICE	MISURA	UM	PZ	€
013 042 015	D.1/2 x 1/2 x Cm 150 x 15 mm	PZ	10	21,70



Doccetta con Pulsante Nero o Bianco

CODICE	MISURA	UM	PZ	€
013 042 012	D.1/2	PZ	10	3,70



Gancio Supporto Doccia Leggero per Flex Normale

CODICE	MISURA	UM	PZ	€
013 042 017	Per Flex Normale	PZ	10	16,30



Gancio supporto Doccia Fisso in ABS Cromo Gaboli

CODICE	MISURA	UM	PZ	€
013 042 038	ABS	PZ	10	3,70



Gancio Supporto Doccia per Flex Conico

CODICE	MISURA	UM	PZ	€
013 042 018	Per Flex Conico	PZ	10	17,90



CODICE	MISURA	UM	PZ	€
013 162 040	3 Jet 13 mm	PZ	1	93,50

Colonna Doccia
Set Mix Cromata Anticalacre
3 Jet Alpha Metaform



CODICE	MISURA	UM	PZ	€
013 162 001	3 Jet Planet in Blister	PZ	5	30,10

Saliscendo Acqualine
Metaform Cromo



CODICE	MISURA	UM	PZ	€
013 162 002	3 Jet Star in Blister	PZ	5	38,60

Saliscendo Acqualine
Metaform Cromo



CODICE	MISURA	UM	PZ	€
013 162 004	5 Jet in Blister	PZ	4	70,30

Saliscendo Acqualine
Metaform Cromo



CODICE	MISURA	UM	PZ	€
013 162 041	4 jet 21 mm	PZ	1	134,10

Colonna Doccia
Set Mix Cromata Anticalacre
4 Jet Universe Metaform



CODICE	MISURA	UM	PZ	€
013 162 010	3 Jet Planet in Blister	PZ	8	12,20

Doccetta Acqualine
3 Jet Metaform Cromo



CODICE	MISURA	UM	PZ	€
013 162 011	3 Jet Planet in Blister	PZ	8	20,40

Doccetta Acqualine
Metaform Cromo
3 Jet Star in Blister



CODICE	MISURA	UM	PZ	€
013 162 012	4 Jet Orbit in Blister	PZ	8	23,60

Doccetta Acqualine
Metaform Cromo
4 Jet Orbit in Blister



CODICE	MISURA	UM	PZ	€
013 162 013	5 Jet Comet in Blister	PZ	8	28,50

Doccetta Acqualine
Metaform Cromo
5 Jet Comet in Blister

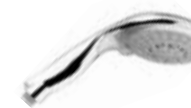

CODICE	MISURA	UM	PZ	€
013 162 020	D.1/2 x 1/2 Cm150	PZ	8	12,60

Flessibile Doccia
Metaform Cromato
Doppia Agraffatura Conico



CODICE	MISURA	UM	PZ	€
013 162 021	D.1/2 x 1/2 Cm150 x 200 F.Conico	PZ	8	15,00

Flessibile Doccia
Metaform Cromato Doppia
Agraffatura Estensibile





SETTORE 015
IDRAULICA



Vasca Acrilico
Solo Guscio a sedere
Bianca Glass

CODICE	MISURA	UM	PZ	€
015 063 062	Cm 105 x 70	PZ	1	223,10
015 063 061	Cm 120 x 70	PZ	1	223,10



Vasca Acrilico
Solo Guscio
Bianca Glass

CODICE	MISURA	UM	PZ	€
015 063 060	Cm 140 x 70	PZ	1	223,10
015 063 050	Cm 150 x 70	PZ	1	223,10
015 063 051	Cm 160 x 70	PZ	1	223,20
015 063 052	Cm 170 x 70	PZ	1	223,20



Vasca Acrilico
con Telaio e Pannello
Bianca Glass

CODICE	MISURA	UM	PZ	€
015 063 046	Cm 160 x 70	PZ	1	1116,00
015 063 047	Cm 170 x 70	PZ	1	1116,00



Vasca Acrilico
Idromassaggio Con Telaio
e Pannello
Bianca Glass

CODICE	MISURA	UM	PZ	€
015 063 041	Cm 160 x 70	PZ	1	1872,30
015 063 042	Cm 170 x 70	PZ	1	1872,30



CODICE	MISURA	UM	PZ	€
017 050 036	Cm 55 x 60 - Con Luci	PZ	1	107,40
017 050 060	Cm 55 x 60 - Senza Luci	PZ	1	78,20

Specchio Bianco Gedy



CODICE	MISURA	UM	PZ	€
017 050 037	Gedy 8010	PZ	1	10,70

Porta Bicchiere Serie Junior Bianco Gedy



CODICE	MISURA	UM	PZ	€
017 050 038	Gedy 8011	PZ	1	10,10

Porta Sapone Serie Junior Bianco Gedy



CODICE	MISURA	UM	PZ	€
017 050 039	Gedy 8019 Cm 60	PZ	1	21,70

Mensola Serie Junior Bianco Gedy



CODICE	MISURA	UM	PZ	€
017 050 040	Gedy 8012	PZ	1	13,10

Porta Sapone e Porta Servietta Serie Junior Bianco Gedy



CODICE	MISURA	UM	PZ	€
017 050 041	Gedy 8021 Cm 55	PZ	1	19,10

Porta Servietta Serie Junior Bianco Gedy



CODICE	MISURA	UM	PZ	€
017 050 042	Gedy 8024	PZ	1	10,10

Porta Rotolo Serie Junior Bianco Gedy



CODICE	MISURA	UM	PZ	€
017 050 043	Gedy 8026	PZ	1	8,60

Appendiabiti Serie Junior Bianco Gedy



CODICE	MISURA	UM	PZ	€
017 050 044	Gedy 8033	PZ	1	10,90

Porta Scopino Serie Junior Bianco Gedy



CODICE	MISURA	UM	PZ	€
017 050 062	Gedy 809902	PZ	1	67,70

Set Accessori Junior Bianco Gedy Completo Kit 9 Pz



CODICE	MISURA	UM	PZ	€
017 050 052	Gedy 2280	PZ	1	43,40

Dosatore Sapone Liquido Bianco Gedy



CODICE	MISURA	UM	PZ	€
017 050 063	Gedy 8079 - Cm 22 x 14 x 38	PZ	1	19,50

Angolo Doccia Bianco Gedy





SETTORE 017

IDRAULICA



Mobile Lavatoio
Inserimento Lavatrice
Bianco Dx

CODICE	MISURA	UM	PZ	€
017 079 026	Cm L109xP60xH90 Dx Rif.Pensile	PZ	1	446,90



Mobile Lavatoio
Inserimento Lavatrice
Bianco Sx

CODICE	MISURA	UM	PZ	€
017 079 027	Cm L109xP60xH90 Sx Rif.Pensile	PZ	1	446,90



Mobile in Legno
Bianco con Lavatoio
in Acrilico Anta Singola

CODICE	MISURA	UM	PZ	€
017 084 014	Cm L45 x P50 x H86	PZ	1	203,20
017 084 0 44	Cm L45 x P60 x H86	PZ	1	235,50
017 084 018	Cm L50 x P50 x H86	pz	1	256,00



Mobile in Legno
Bianco con Lavatoio
in Acrilico Anta Doppia

CODICE	MISURA	UM	PZ	€
017 084 015	Cm L60 x P50 x H86	PZ	1	256,00
017 084 016	Cm L60 x P60 x H86	PZ	1	256,00



Mobile Lavatoio
Interamente in Acrilico
in Resina Anta Singola

CODICE	MISURA	UM	PZ	€
017 084 060	Cm L45 x P50 x H86	PZ	1	284,40



Mobile Lavatoio
Interamente in Acrilico
in Resina Anta Doppia

CODICE	MISURA	UM	PZ	€
017 084 061	Cm L60 x P50 x H86	PZ	1	284,40
017 084 062	Cm L60 x P60 x H86	PZ	1	261,70



CODICE	MISURA	UM	PZ	€
017 084 030	Cm L60xP50xH86 Ald	PZ	1	203,20

Mobile in Legno
Bianco con Lavatoio
in Acrilico Ald Anta Doppia



CODICE	MISURA	UM	PZ	€
017 084 031	Cm L50xP50xH86 Ald	PZ	1	203,20

Mobile in Legno
Bianco con Lavatoio
in Acrilico Ald Anta Singola



CODICE	MISURA	UM	PZ	€
017 084 032	Cm L60xP60xH86 Ald	PZ	1	203,20

Mobile in Legno
Bianco con Lavatoio
in Acrilico Ald Anta Doppia



CODICE	MISURA	UM	PZ	€
017 084 033	Cm L45xP50xH86 Ald	PZ	1	203,20

Mobile in Legno Bianco con
Lavatoio in Acrilico Ald Anta
Singola



CODICE	MISURA	UM	PZ	€
017 084 034	Cm L50xP40xH86 Ald	PZ	1	203,20

Mobile in Legno
Bianco con Lavatoio
in Acrilico Ald Anta Singola





SETTORE 017

IDRAULICA



Sottolavello Pieghevole
per lavello Inox e Ceramica
Bianco

CODICE	MISURA	UM	PZ	€
017 084 045	Cm L80 x P50	PZ	1	172,90
017 084 047	Cm L120 x P50	PZ	1	246,00



Sottolavello Pieghevole
per lavello Inox e Ceramica
Tek

CODICE	MISURA	UM	PZ	€
017 084 046	Cm L80 x P50	PZ	1	187,90
017 084 048	Cm L120 x P50	PZ	1	246,00



Lavello Acciaio Inox
per Sottolavelli Dx 1 Coppe

CODICE	MISURA	UM	PZ	€
017 084 070	Cm L80 x P50 1 Coppa	PZ	1	158,50



Lavello Acciaio Inox
per Sottolavelli Dx 2 Coppe

CODICE	MISURA	UM	PZ	€
017 084 072	Cm L120 x P50 2 Coppe	PZ	1	199,10



Lavello Acciaio Inox
per Sottolavelli Sx 1 Coppe

CODICE	MISURA	UM	PZ	€
017 084 071	Cm L80 x P50 1 Coppa	PZ	1	158,50



Lavello Acciaio Inox
per Sottolavelli Sx 2 Coppe

CODICE	MISURA	UM	PZ	€
017 084 073	Cm L120 x P50 2 Coppe	PZ	1	199,10



Pilozzino a Parete
in Polipropilene
per uso Esterno Bianco

CODICE	MISURA	UM	PZ	€
017 084 054	Cm L50xP35x24	PZ	1	66,40



CODICE	MISURA	UM	PZ	€
017 080 010	Cm L60xH174xP46 Bianco Lucido	PZ	1	1084,80
017 080 015	Cm L80xH174xP46 Bianco Lucido	PZ	1	1340,10
017 080 016	Cm L80xH174xP46 Matrix Bianco	PZ	1	1218,80
017 080 017	Cm L80xH174xP46 Larice Bianco	PZ	1	1218,80
017 080 018	Cm L80xH174xP46 Olmo Rosso	PZ	1	1218,80
017 080 020	Cm L105xH174xP46 Bianco Lucido	PZ	1	1549,20
017 080 021	Cm L105xH174xP46 Matrix Bianco	PZ	1	1405,70
017 080 022	Cm L105xH174xP46 Larice Bianco	PZ	1	1429,60
017 080 023	Cm L105xH174xP46 Olmo Rosso	PZ	1	1405,70

COLORI ORDINABILI



MATRIX
BIANCO

LARICE
BIANCO

OLMO
ROSSO

Mobile Completo
Venus Mobilduenne



SETTORE 017

IDRAULICA

CODICE	MISURA	UM	PZ	€
017 080 025	Cm L84xH174xP46 Bianco Lucido	PZ	1	1137,60
017 080 026	Cm L84xH174xP46 Matrix Bianco	PZ	1	1137,60
017 080 027	Cm L84xH174xP46 Larice Bianco	PZ	1	1137,60
017 080 028	Cm L84xH174xP46 Olmo Rosso	PZ	1	1137,60
017 080 030	Cm L100xH174xP46 Bianco Lucido	PZ	1	1377,30
017 080 031	Cm L100xH174xP46 Matrix Bianco	PZ	1	1377,30
017 080 032	Cm L100xH174xP46 Larice Bianco	PZ	1	1377,30
017 080 033	Cm L100xH174xP46 Olmo Rosso	PZ	1	1377,30

COLORI ORDINABILI



MATRIX
BIANCO

LARICE
BIANCO

OLMO
ROSSO

Mobile Completo
Moon Mobilduenne





SETTORE 017

IDRAULICA



Specchiera Bianca
a due Antine Liscie

CODICE	MISURA	UM	PZ	€
017 117 034	Cm L80 x P15	PZ	1	97,60



Specchiera Bianca
a una Antina Liscia

CODICE	MISURA	UM	PZ	€
017 117 035	Cm L62 x P15	Pz	1	89,40



Specchiera Bianca
a due Antine all'Inglese

CODICE	MISURA	UM	PZ	€
017 117 036	Cm L80 x P15	PZ	1	97,60



Specchiera Bianca
a Una Antina all'Inglese

CODICE	MISURA	UM	PZ	€
017 117 037	Cm L62 x P15	PZ	1	109,70



CODICE	MISURA	UM	PZ	€
017 117 045	Cm L85xH196P48 Bianco Laguna 85 PL	PZ	1	446,90
017 117 050	Cm L105xH196P48 Bianco Laguna 105PL	PZ	1	670,40

Mobile Bagno
Lavabo Ceramica Pensile
e Specchio



SETTORE 017

IDRAULICA

CODICE	MISURA	UM	PZ	€
017 117 055	Cm L85xH196P48 Larice Grigio Gaia 85 C	PZ	1	629,80

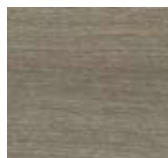

Larice Grigio

Mobile Bagno
Lavabo Ceramica Pensile
e Specchio



CODICE	MISURA	UM	PZ	€
017 117 060	Cm L81xH190P47 Larice G. - Angela 80 - Senza Colonna	PZ	1	589,10
017 117 061	Cm L81xH190P47 Rovere wel - Angela 80 - Senza Colonna	PZ	1	589,10
017 117 063	Cm L101xH195P47 Larice G. - Angela 100 - Senza Colonna	PZ	1	670,40
017 117 064	Cm L101xH195P47 Rovere We - Angela 100 - Senza Colonna	PZ	1	670,40



Larice Grigio Rovere Well

Mobile Bagno Sospeso
2 Cassettoni
e Specchio



CODICE	MISURA	UM	PZ	€
017 117 065	Cm L25xH160P22 Larice G. - Mod. 088	PZ	1	223,50
017 117 066	Cm L25xH160P22 Rovere W. - Mod. 088	PZ	1	223,50



Larice Grigio Rovere Well

Colonna Singola Sospesa
Mobile Bagno





SETTORE 017
IDRAULICA



Mobile Bagno
Sospeso 2 Cassettoni
e Specchio

CODICE	MISURA	UM	PZ	€
017117070	Cm L120xH195P47 Senza colonna Olmo Grigio - Luna 80	PZ	1	792,30
017117074	Semicolonna - Cm L54xH92P34 Olmo Grigio - Mod.303	PZ	1	223,50



Mobile Bagno
Lavabo Ceramica
Pensile e Specchio

CODICE	MISURA	UM	PZ	€
017 117 080	Cm L85xH195P50 Senza colonna Olmo Grigio - MARTA85SC	PZ	1	650,10
017 117 085	Cm L105xH195P50 Senza colonna Olmo Grigio - MARTA105SC	PZ	1	751,60
017 117 095	Semicolonna - MOD694 Cm L27 x H92 x P34 Olmo Grigio	PZ	1	235,70
017 117 097	Semicolonna Doppia - MOD695 Cm L54 x H92 x P68 Olmo Grigio	PZ	1	304,70



Mobile Bagno
Lavabo Ceramica
Pensile e Specchio

CODICE	MISURA	UM	PZ	€
017 117 081	Cm L85xH195P50 Senza colonna Olmo Bianco - MARTA85SC	PZ	1	650,10
017 117 086	Cm L105xH195P50 Senza colonna Olmo Bianco - MARTA105SC	PZ	1	751,60
017 117 096	Semicolonna - MOD694 Cm L27 x H92 x P34 Olmo Bianco	PZ	1	235,70
017 117 098	Semicolonna Doppia - MOD695 Cm L54 x H92 x P68 Olmo Bianco	PZ	1	304,70



CODICE	MISURA	UM	PZ	€
017 162 022	in Scatola Con Porta Scopino	PZ	5	85,40
017 162 020	in Scatola Senza Porta Scopino	PZ	5	71,10

Set Accessori
in Plastica Pesante
Serie Linea Metaform
Kit T3 Bianco



CODICE	MISURA	UM	PZ	€
017 162 025	Cm 16x11x10	PZ	1	20,50

Porta Bicchiere
Serie Linea Metaform
Bianco



CODICE	MISURA	UM	PZ	€
017 162 026	Cm 25x6	PZ	1	21,30

Porta Sapone e Spugna
Serie Linea Metaform
Bianco



CODICE	MISURA	UM	PZ	€
017 162 027	Cm 16x11	PZ	1	15,40

Porta Sapone
Serie Linea Metaform
Bianco



CODICE	MISURA	UM	PZ	€
017 162 028	Cm 56x11	PZ	1	25,20
017 162 029	Cm 30x11	PZ	1	22,10

Porta Asciugamano
Serie Linea Metaform
Bianco



CODICE	MISURA	UM	PZ	€
017 162 030	Cm 20x11	PZ	1	16,50

Porta Rotolo e Salvietta
Serie Linea Metaform
Bianco



CODICE	MISURA	UM	PZ	€
017 162 031	Cm 20x7	PZ	1	13,70

Appendiabiti
Serie Linea Metaform
Bianco



CODICE	MISURA	UM	PZ	€
017 162 057	Cm 41	PZ	1	33,80

Porta Asciugamano Snodo
Serie Linea Metaform
Bianco



CODICE	MISURA	UM	PZ	€
017 162 058	Cm 56	PZ	1	25,20

Mensola di Appoggio
Serie Linea Metaform
Bianca



CODICE	MISURA	UM	PZ	€
017 162 059	Metaform 199B45099	PZ	0	3,30

Ganci Supporto Accessori
Linea in Plastica Pesante





SETTORE 017

IDRAULICA



Set Accessori
Ottone Cromato
Serie One Metaform

CODICE	MISURA	UM	PZ	€
017 162 061	8 Pz C/Porta Scopino	PZ	5	126,00



Porta Sapone
Ottone Cromato
Serie One Metaform

CODICE	MISURA	UM	PZ	€
017 162 062		PZ	5	22,70



Porta Spazzolino
Ottone Cromato
Serie One Metaform

CODICE	MISURA	UM	PZ	€
017 162 063		PZ	5	22,70



Porta Asciugamano cm 60
Ottone Cromato
Serie One Metaform

CODICE	MISURA	UM	PZ	€
017 162 064	Cm 60	PZ	5	34,10



Porta Asciugamano Anello
Ottone Cromato
Serie One Metaform

CODICE	MISURA	UM	PZ	€
017 162 065		PZ	5	28,80



Appendiabiti
Ottone Cromato
Serie One Metaform

CODICE	MISURA	UM	PZ	€
017 162 066		PZ	5	18,60



Porta Rotolo Aperto
Ottone Cromato
Serie One Metaform

CODICE	MISURA	UM	PZ	€
017 162 067		PZ	5	24,90



Porta Scopino Chiuso
Ottone Cromato
Serie One Metaform

CODICE	MISURA	UM	PZ	€
017 162 068		PZ	5	49,60
017 162 071	Fissaggi Serie One	PZ	5	8,30



Piantana Snodo
Portasciugamano
Ottone Cromato
Wind Metaform

CODICE	MISURA	UM	PZ	€
017 162 055	Cm 23 x H 91	PZ	5	77,20



CODICE	MISURA	UM	PZ	€
024 118 042	Lavabo - Cm L65 x P53 x H22	PZ	1	125,10
024 118 044	Lavabo - Cm L60 x P50 x H19	PZ	1	134,20
024 118 043	Lavabo - Cm L55 x P45 x H19	PZ	1	120,50
024 118 045	Colonna - Cm H700	PZ	1	81,90
024 118 076	Semicolonna - Cm H320	PZ	1	102,20
024 118 047	Bidet 1F - mm L356 x P540 x H390	PZ	1	149,40
024 118 046	Bidet 3F - mm L356 x P540 x H390	PZ	1	99,70
024 118 048	Vaso Scarico a Pavimento mm L356 x P540 x H390	PZ	1	158,60
005 039 006	Sedile Legno Bianco	PZ	1	70,30

Sanitari Pozzi-Ginori
Serie Selnova 3



SETTORE 024

IDRAULICA

CODICE	MISURA	UM	PZ	€
024 118 119	Lavabo mm L650 x P490 x H185	PZ	1	109,70
024 118 090	Lavabo mm L550 x P420 x H175	PZ	1	88,70
024 118 101	Colonna mm H700	PZ	1	76,20
024 118 092	Bidet 1F mm L360 x P530 x H390	PZ	1	122,60
024 118 093	Vaso Scarico a Pavimento mm L360 x P530 x H390	PZ	1	113,30
005 175 004	Sedile Legno Bianco	PZ	1	74,20
024 118 106	Vaso Scarico a Parete	PZ	1	134,30
024 181 016	Semicolonna	PZ	1	40,00

Sanitari Pozzi-Ginori
Serie Colibrì 2 a Terra
e a Parete



CODICE	MISURA	UM	PZ	€
024 118 098	Vaso - mm L360 x P520 x H350	PZ	1	117,70
	Bidet 1F - mm L360 x P530 x H350	PZ	1	121,40
005 175 004	Sedile Bianco	PZ	1	74,20
008 030 010	Coppia Staffe Universale Bidet Wc	PZ	1	21,60

Sanitari Pozzi-Ginori
Serie Colibrì 2 Sospesi





SETTORE 024

IDRAULICA



Sanitari Pozzi-Ginori Serie Kim



CODICE	MISURA	UM	PZ	€
024 014 001	Lavabo - Cm L60 x P50 x H19	PZ	1	87,00
024 014 002	Colonna - mm H700	PZ	1	59,50
024 014 003	Bidet 1F - Cm L36 x P51 x H39	PZ	1	98,60
024 014 004	Vaso a Pavimento Cm L36 x P54 x H39	PZ	1	103,40
024 014 005	Cassetta Alta Bianco Opera	PZ	1	70,70
005 174 004	Sedile Legno Universale	PZ	1	74,20



Lavabo d'Arredo
Semincasso Club
Pozzi Ginori Bianco

CODICE	MISURA	UM	PZ	€
024 118 025	Cm L64 x P52 x H21	PZ	1	526,50



Lavabo d'Arredo
Incasso Soprapiano Emi
Pozzi Ginori Bianco

CODICE	MISURA	UM	PZ	€
024 118 023	Cm L63 x P53 x H20	PZ	1	566,30



Lavabo d'Arredo
Incasso Soprapiano
Florarredo Pozzi Ginori
Bianco

CODICE	MISURA	UM	PZ	€
024 118 061	Cm L68 x P48 x H20	PZ	1	537,90



Lavabo d'Arredo
Incasso Sottopiano Denver
Pozzi Ginori Bianco

CODICE	MISURA	UM	PZ	€
024 118 022	Cm L57 x P43 x H22	PZ	1	328,90



CODICE	MISURA	UM	PZ	€
024 118 054	Cm 90 x 70 x 7	PZ	1	373,30

Piatto Doccia
Angolare Asimmetrico
Seventy Sinistro
Pozzi Ginori Bianco



CODICE	MISURA	UM	PZ	€
024 118 050	Cm 90 x 90 x 11	PZ	1	306,30
024 118 049	Cm 80 x 80 x 11	PZ	1	231,50

Piatto Doccia
Angolare Neva 90
Pozzi Ginori Bianco



CODICE	MISURA	UM	PZ	€
024 118 052	Cm 120 x 80 x 11	PZ	1	324,50

Piatto Doccia
 Rettangolare Reno
Pozzi Ginori Bianco



CODICE	MISURA	UM	PZ	€
024 118 053	Cm 90 x 70 x 7	PZ	1	373,30

Piatto Doccia
Angolare Asimmetrico
Seventy Destro
Pozzi Ginori Bianco



CODICE	MISURA	UM	PZ	€
024 118 013	Cm 100 x 75 x 9,5 - Nilo 100	PZ	1	245,70
024 118 016	Cm 90 x 72 x 11 - Nilo 90	PZ	1	197,00

Piatto Doccia
 Rettangolare
Pozzi Ginori Bianco



CODICE	MISURA	UM	PZ	€
024 118 051	Cm 90 x 90 x 11	PZ	1	334,80

Piatto Doccia
Quadrato Sangro
Pozzi Ginori Bianco





SETTORE 024
IDRAULICA



Piatto Doccia
Quadrato Naviglio
Pozzi Ginori Bianco

CODICE	MISURA	UM	PZ	€
024 118 015	Cm 72 x 72 x 11	PZ	1	137,40
024 118 014	Cm 75 x 75 x 11	PZ	1	189,50
024 118 097	Cm 80 x 80 x 11	PZ	1	174,10



Piatto Doccia
Quadrato Filo Pavimento
Abele 90
Pozzi Ginori Bianco

CODICE	MISURA	UM	PZ	€
024 118 157	Cm 90 x 90 x 7	PZ	1	723,50



Piatto Doccia
 Rettangolare Seventy
Pozzi Ginori Bianco

CODICE	MISURA	UM	PZ	€
024 118 056	Cm 100 x 80 x 7 Seventy 100	PZ	1	427,10



Piatto Doccia
 Rettangolare Reno XP
Pozzi Ginori Bianco

CODICE	MISURA	UM	PZ	€
024 118 107	Cm 90 x 72 x 6,2 - Reno XP	PZ	1	197,00
024 118 108	Cm 100 x 80 x 6,2 Reno XP	PZ	1	283,00
024 118 109	Cm 120 x 80 x 6,2 Reno XP	PZ	1	355,40



Piatto Doccia
 Rettangolare Seventy
Pozzi Ginori Bianco

CODICE	MISURA	UM	PZ	€
024 118 055	Cm 120 x 80 x 7	PZ	1	437,60



CODICE	MISURA	UM	PZ	€
024 042 001	Cm 70 x 70 x 3,5	PZ	1	206,80
024 042 002	Cm 80 x 80 x 3,5	PZ	1	215,40

Piatto Doccia
Acrilico Quadrato Bianco Clear Gold
Antibatterico



CODICE	MISURA	UM	PZ	€
024 042 010	Cm 100x 70 x 3,5	PZ	1	361,80
024 042 011	Cm 100x 80 x 3,5	PZ	1	396,20
024 042 012	Cm 120x 70 x 3,5	PZ	1	413,50
024 042 013	Cm 120x 80 x 3,5	PZ	1	430,70
024 042 014	Cm 140x 80 x 3,5	PZ	1	637,40
024 042 015	Cm 150x 70 x 3,5	PZ	1	654,10
024 042 016	Cm 150x 80 x 3,5	PZ	1	826,90
024 042 017	Cm 160x 70 x 3,5	PZ	1	775,20
024 042 018	Cm 160x 80 x 3,5	PZ	1	895,80

Piatto Doccia
Acrilico Rettangolare Bianco Clear Gold
Antibatterico



CODICE	MISURA	UM	PZ	€
024 042 025	Cm 90 x 90 x 3,5	PZ	1	390,10
024 042 039	Cm 76 x 76 x 3,5	PZ	1	172,30

Piatto Doccia
Acrilico Quadrato Tondo Bianco Clear Gold
Antibatterico





Piatto Doccia
Acrilico Quadrato Bianco Clear Green

CODICE	MISURA	UM	PZ	€
024 042 040	Cm 80 x 80 x 3,5	PZ	0	188,60
024 042 041	Cm 90 x 90 x 3,5	PZ	0	259,90



Piatto Doccia
Acrilico Rettangolare Bianco Clear Green

CODICE	MISURA	UM	PZ	€
024 042 050	Cm 90 x 70 x 3,5	PZ	0	310,10
024 042 051	Cm 70 x100 x 3,5	PZ	0	303,20
024 042 052	Cm 80 x100 x 3,5	PZ	0	311,90
024 042 053	Cm 70 x120 x 3,5	PZ	0	294,50
024 042 054	Cm 80 x120 x 3,5	PZ	0	318,70



Piatto Doccia
Acrilico Quadrato Tondo Bianco Clear Green

CODICE	MISURA	UM	PZ	€
024 042 060	Cm 90 x 90 x 3,5	PZ	1	308,80



CODICE	MISURA	UM	PZ	€
024 014 022	Cm L38 x P58 x H48	PZ	1	234,70

Vaso Bidet Ergonomico per Disabili
Scarico Pavimento Bianco
Con Kit Erogazione



CODICE	MISURA	UM	PZ	€
024 014 021	Cm L38 x P58 x H49 Scarico a Pavimento	PZ	1	191,60
024 014 023	Cm L38 x P58 x H49 Scarico a Parete	PZ	1	191,60

Vaso Ergonomico per Disabili
Bianco



CODICE	MISURA	UM	PZ	€
024 014 025	Scarico a Parete	PZ	1	280,00
024 014 026	Scarico a Pavimento	PZ	1	280,00

Vaso Anziano Terza Età



CODICE	MISURA	UM	PZ	€
024 014 027		PZ	1	280,00

Bidet Anziano Terza Età



CODICE	MISURA	UM	PZ	€
024 014 029	Scarico a Pavimento	PZ	1	215,40
024 014 030	Scarico a Parete	PZ	1	215,40

Vaso Infanzia



CODICE	MISURA	UM	PZ	€
024 014 020	Cm L65 x P57 x H23,5	PZ	1	191,60

Lavabo Ergonomico per Disabili
Scarico Pavimento Bianco



CODICE	MISURA	UM	PZ	€
005 175 009	Bemis	PZ	1	73,20

Sedile per Wc Disabili
Termo Indurente Bianco





SETTORE 024

IDRAULICA



Vaso Serie O.Novo
Sospeso
Villeroy & Boch Bianco

CODICE	MISURA	UM	PZ	€
024 119 023	Cm L36 x P56	PZ	1	185,60



Bidet 1F Serie O.Novo
Sospeso
Villeroy & Boch Bianco

CODICE	MISURA	UM	PZ	€
024 119 022	Cm L36 x P56	PZ	1	185,60



Vaso Serie O.Novo
Pavimento
Villeroy & Boch Bianco

CODICE	MISURA	UM	PZ	€
024 119 029	Cm L36 x P56	PZ	1	223,50



Bidet 1F Serie O.Novo
Pavimento
Villeroy & Boch Bianco

CODICE	MISURA	UM	PZ	€
024 119 028	Cm L36 x P56	PZ	1	223,50



Lavabo Serie O.Novo
Villeroy & Boch Bianco

CODICE	MISURA	UM	PZ	€
024 119 020	Cm L65 x P51	PZ	1	174,70
024 119 019	Cm L60 x P48	PZ	1	167,60



Colonna Serie O.Novo
Villeroy & Boch Bianco

CODICE	MISURA	UM	PZ	€
024 119 021	Cm L67	PZ	1	109,90



Semicolonna Serie O.Novo
Villeroy & Boch Bianco

CODICE	MISURA	UM	PZ	€
024 119 026		PZ	1	129,80



Sedile Wc
Serie O.Novo
Villeroy & Boch Bianco

CODICE	MISURA	UM	PZ	€
024 119 024	Chiusura Normale	PZ	1	127,30
024 119 025	Seat Softclosing	PZ	1	233,10



Coppia Staffe Fissaggio
Sanitari Sospesi Bidet/Wc

CODICE	MISURA	UM	PZ	€
008 030 010	Vaso e Bidet Universale	PZ	10	21,60
008 030 011	Staffa Bidet Pesante	PZ	10	66,50
008 030 012	Staffa Vaso Pesante	PZ	10	66,50



CODICE	MISURA	UM	PZ	€
024 033 040	Cm 65x47 Cod. J509701	PZ	0	77,20
024 033 041	Cm 60x47 Cod. J509601	PZ	0	69,10
024 033 042	Cm 50x47 Cod. J509801	PZ	0	65,10

Lavabo Kati
Bianco
Ideal Standard



CODICE	MISURA	UM	PZ	€
024 033 045	Cod. J509901	PZ	0	32,60

Colonna Kati
Bianco
Ideal Standard



CODICE	MISURA	UM	PZ	€
024 033 046	Cod. J510201	PZ	0	32,60

Semicolonna Kati
Bianco Ideal Standard



CODICE	MISURA	UM	PZ	€
024 033 050	Cod. J509401 - Cm 50x35x39	PZ	0	85,40

Vaso Kati
Scarico Pavimento Bianco
Ideal Standard



CODICE	MISURA	UM	PZ	€
024 033 051	Cod. J510801 - Cm 51x35x40	PZ	0	85,40

Vaso Kati
Scarico Parete Bianco
Ideal Standard



CODICE	MISURA	UM	PZ	€
024 033 055	Cod. J510001 - Cm 52x36x40	PZ	0	85,40

Vaso Kati Sospeso
Bianco
Ideal Standard



CODICE	MISURA	UM	PZ	€
024 033 060	Cod. J510801 - Cm 50x35x39	PZ	0	85,40

Bidet Kati Pavimento
Bianco
Ideal Standard



CODICE	MISURA	UM	PZ	€
024 033 061	Cod. J510101 - Cm 52x35x40	PZ	0	85,40

Bidet Kati Sospeso
Bianco
Ideal Standard





SETTORE 024

IDRAULICA



Lavabo Quarzo
Bianco Ideal Standard

CODICE	MISURA	UM	PZ	€
024 033 070	Cm 65x50	1		100,20
024 033 071	Cm 60x47	1		96,30



Colonna Quarzo
Bianco Ideal Standard

CODICE	MISURA	UM	PZ	€
024 033 075		1		72,20



Semicolonna Quarzo
Bianco Ideal Standard

CODICE	MISURA	UM	PZ	€
024 033 076		1		70,10



Vaso Quarzo Filo Parete
Scarico Pavimento
Ideal Standard

CODICE	MISURA	UM	PZ	€
024 033 080	Cm 36,5x53,5x40	1		197,10



Bidet Quarzo
Filo Parete Terra
Ideal Standard

CODICE	MISURA	UM	PZ	€
024 033 085	Cm 35,5x53x40	1		183,10



Sedile Wc
Serie Quarzo
Ideal Standard

CODICE	MISURA	UM	PZ	€
024 033 088		1		54,00



CODICE	MISURA	UM	PZ	€
026 051 002	Lt500 D650 x A850 x L1450	PZ	1	417,10
026 051 003	Lt750 D750 x A900 x L1700	PZ	1	520,10
026 051 004	Lt1000 D850 x A950 x L1700	PZ	1	583,90
026 051 005	Lt1500 D1100 x A1250 x L1600	PZ	1	1005,90
026 051 006	Lt2000 D1100 x A1250 x L2200	PZ	1	1187,40
026 051 007	Lt3000 D1270 x A1450 x L2400	PZ	1	2512,40
026 051 008	Lt4000 D1430 x A1600 x L2500	PZ	1	2320,80
026 051 009	Lt5000 D1600 x A1750 x L2500	PZ	1	2566,10

Serbatoio Zincato
Orizzontale



Ordinabili solo su richiesta

CODICE	MISURA	UM	PZ	€
026 051 013	Lt300 D600 x H1250	PZ	1	319,00
026 051 014	Lt500 D650 x H1850	PZ	1	417,10
026 051 015	Lt750 D750 x H1850	PZ	1	574,10
026 051 016	Lt1000 D850 x H1850	PZ	1	595,00
026 051 017	Lt1500 D1100 x H1850	PZ	1	917,50
026 051 018	Lt2000 D1100 x H2300	PZ	1	1187,40
026 051 019	Lt3000 D1270 x H2600	PZ	1	1673,10
026 051 020	Lt4000 D1430 x H2650	PZ	1	2320,80
026 051 021	Lt5000 D1600 x H2650	PZ	1	2566,10

Serbatoio Zincato
Verticale



Ordinabili solo su richiesta

CODICE	MISURA	UM	PZ	€
026 051 010	Lt1000 P700 X H1700 X L1150	PZ	1	1089,30
026 051 011	Lt1500 P700 X H1700 X L1600	PZ	1	1383,70
026 051 012	Lt2000 P700 X H1700 X L2100	PZ	1	1854,70

Serbatoio Zincato
Ovale Orizzontale



Ordinabili solo su richiesta

CODICE	MISURA	UM	PZ	€
026 051 049	Lt300 P520 X H750 X L750	PZ	1	390,10
026 051 048	Lt500 P500 X H1000 X L1000	PZ	1	536,30
026 051 051	Lt1000 P600 X H1250 X L1250	PZ	1	772,40
026 051 050	Lt2000 P620 X H1500 X L2000	PZ	1	1565,20

Serbatoio Zincato
Parallelepipedo



Ordinabili solo su richiesta

CODICE	MISURA	UM	PZ	€
026 051 035	Lt100 D400 x H1007	PZ	1	371,60
026 051 036	Lt200 Lt200 D450 x H1407	PZ	1	498,80
026 051 037	Lt300 Lt100D550 x H1519	PZ	1	594,20
026 051 038	Lt500 D650 x H1811	PZ	1	939,90
026 051 039	Lt1000 D850 x H2162	PZ	1	1222,90

Serbatoio Zincato
Accumulo Verticale
non Collaudato



CODICE	MISURA	UM	PZ	€
026 051 090	Lt100 D400 x H1055	PZ	1	341,90
026 051 091	Lt200 D450 x H1420	PZ	1	711,80
026 051 092	Lt300 D550 x H1530	PZ	1	848,30
026 051 093	Lt500 D650 x H1825	PZ	1	1188,40
026 051 094	Lt1000 D790 x H2380	PZ	1	1950,10
026 051 095	Lt2000 D100 X H2535	PZ	1	4103,30

Serbatoio Zincato
Accumulo Verticale
Collaudato





Serbatoio Polietilene
Orizzontale

CODICE	MISURA	UM	PZ	€
026 051 057	Lt300 A 82 x L 73 x P 82	PZ	1	228,50
026 051 043	Lt500 A 94 x L 87 x P 98	PZ	1	336,40
026 051 040	Lt1000 A115 x L106 x P127	PZ	1	438,00
026 051 047	Lt1500 A133 x L125 x P155	PZ	1	590,50
026 051 044	Lt2000 A144 x L136 x P155	PZ	1	716,10
026 051 056	Lt3000 A166 x L160 x P185	PZ	1	1052,20



Serbatoio Polietilene
Verticale

CODICE	MISURA	UM	PZ	€
026 051 067	Lt200 A 85 x L 60 x P 60	PZ	1	197,50
026 051 058	Lt300 A 97 x L 70 x P 70	PZ	1	228,50
026 051 059	Lt3000 A198 x L147 x P147	PZ	1	888,60



Serbatoio Polietilene
da Interro Orizzontale

CODICE	MISURA	UM	PZ	€
026 051 081	Lt1000 A115 x L106 x P127	PZ	1	875,30
026 051 082	Lt1500 A133 x L125 x P137	PZ	1	1108,40



Serbatoio Polietilene
da Interro Verticale

CODICE	MISURA	UM	PZ	€
026 051 083	Lt2000 A144 x L135 x P145	PZ	1	1240,10
026 051 084	Lt3000 A166 x L160 x P185	PZ	1	1975,80



Serbatoio Polietilene
Sottoscala

CODICE	MISURA	UM	PZ	€
026 051 104	Lt500 SpsR A91 x L69 x P138	PZ	1	352,10
026 051 106	Lt1000 SpsR A105x L90 x P180	PZ	1	693,00



Serbatoio Polietilene
Verticale Onda

CODICE	MISURA	UM	PZ	€
026 051 130	Lt500 A110 x L 80	PZ	1	200,00
026 051 041	Lt1000 A215 x L 80	PZ	1	320,10



Serbatoio Polietilene
Verticale Onda

CODICE	MISURA	UM	PZ	€
026 051 133	Lt1500 A149 x L120	PZ	1	423,40
026 051 134	Lt2000 A195 x L120	PZ	1	511,10



Serbatoio Polietilene
Orciobello

CODICE	MISURA	UM	PZ	€
026 051 100	Lt300 A 96 x L 83 x P 83	PZ	1	290,20
026 051 101	Lt500 A111 x L 98 x P 98	PZ	1	396,10
026 051 102	Lt1000 A140 x L116 x P116	PZ	1	540,10



Serbatoio Polietilene
da Interro IMHOFF Lt NEW
per Fognatuta

CODICE	MISURA	UM	PZ	€
026 051 120	Lt690 A111 x L107 x P107	PZ	1	833,20
026 051 121	Lt910 A121 x L117 x P117	PZ	1	1028,30
026 051 122	Lt1500 A150 x L136 x P136	PZ	1	1343,90



CODICE	MISURA	UM	PZ	€
026 051 069	Lt300 A70 x L66 x P 88	PZ	1	294,10

Serbatoio
Polietilene Quadro



CODICE	MISURA	UM	PZ	€
026 051 070	Lt300 A71 x L 92 x P111	PZ	1	336,10

Serbatoio
Polietilene Quadro



CODICE	MISURA	UM	PZ	€
026 051 079	Lt 510 L68xA116xP87	PZ	1	321,50

Serbatoio
Polietilene Quadro
Verticale



CODICE	MISURA	UM	PZ	€
026 051 075	Lt300 L68xA166xD51	PZ	1	238,20

Serbatoio
Polietilene Verticale Alto



CODICE	MISURA	UM	PZ	€
026 051 073	Lt1500 A146 x L 77 x P167	PZ	1	949,00

Serbatoio
Polietilene Quadro



CODICE	MISURA	UM	PZ	€
026 051 074	Lt2000 A164 x L 75 x P213	PZ	1	1136,10

Serbatoio
Polietilene Quadro



CODICE	MISURA	UM	PZ	€
026 051 072	Lt1000 A142 x L 69 x P156	PZ	1	529,30

Serbatoio
Polietilene Quadro





Serbatoio Polietilene
Verticale Rototec

CODICE	MISURA	UM	PZ	€
026 187 001	Lt 300 V 300 - D. 63 H 152	PZ	1	179,60
026 187 002	Lt 500 V 500 - D. 68 H 152	PZ	1	248,70
026 187 003	Lt 1000 V 1000 - D. 85 H 193	PZ	1	373,00
026 187 004	Lt 2000 V 2000 - D. 115 H 210	PZ	1	552,60
026 187 005	Lt 3000 V 3000 - D. 135 H 230	PZ	1	560,80



Serbatoio Polietilene
Orizzontale Rototec

CODICE	MISURA	UM	PZ	€
026 187 010	Lt 300 C300 Lung. 121 Larg. 57 H. 66	Pz	1	179,60
026 187 011	Lt 565 C500 Lung. 120 Larg. 80 H. 83	Pz	1	248,70
026 187 015	Lt 1020 C1000 Lung. 155 Larg. 97 H. 104	Pz	1	373,00
026 187 012	Lt 1665 C1500 Lung. 170 Larg. 115 H. 122	Pz	1	524,90
026 187 013	Lt 2200 C2000 Lung. 190 Larg. 125 H. 132	Pz	1	663,10
026 187 014	Lt 3260 C3000 Lung. 210 Larg. 145 H. 152	Pz	1	925,50



Serbatoio Polietilene
Panettone Rototec

CODICE	MISURA	UM	PZ	€
017 117 020	Lt 538 P500 - D. 100 H 80	Pz	1	223,80
017 117 021	Lt 1040 P1000 - D. 120 H 105	Pz	1	313,60
017 117 022	Lt 3105 P3000 - D. 183 H 135	Pz	1	676,90



Serbatoio Polietilene Valigia
Rototec

CODICE	MISURA	UM	PZ	€
017 117 030	Lt 500 RV500 Lung. 80 Larg. 55 H. 80	PZ	1	303,90
017 117 031	Lt 500 RV500 Lung. 80 Larg. 55 H. 130			442,10



RISCALDAMENTO



Riscaldamento Termo Sanitari

Tel.: +39 0962 82473 - Fax.: +39 0962 82388 : <http://www.ritesa.it> - : info@ritesa.it



Radiatore Alluminio
Bianco Aperto
Sahara Super Fondital

CODICE	MISURA	UM	PZ	€
014 157 001	H 800 dT50 W 175,9	PZ	1	24,40
014 157 006	H 700 dT50 W 160,1	PZ	1	22,70
014 157 002	H 600 dT50 W 144,7	PZ	1	20,70
014 157 007	H 500 dT50 W 125,2	PZ	1	19,50



Radiatore Alluminio
Bianco Aperto
Ragall Fondital

CODICE	MISURA	UM	PZ	€
014 157 014	H 500 dT50 W 107,6 Kcal/h92	PZ	10	18,90
014 157 013	H 600 dT50 W 123,5 Kcal/h106	PZ	10	21,10
014 157 012	H 700 dT50 W 138,8 Kcal/h119	PZ	10	25,10
014 157 011	H 800 dT50 W 154,8 Kcal/133	PZ	10	26,70



Radiatore Alluminio
Bianco
Garda Dual 80 Fondital

CODICE	MISURA	UM	PZ	€
014 157 015	H 1866 Inter. 1800 Profondità 80 - dT50 Watt 288	PZ	5	109,30



CODICE	MISURA	UM	PZ	€
014 151 038	H 770 x L 450 Inter.400 Wat 569	PZ	1	101,70
014 151 039	H 770 x L 500 Inter.450 Wat 569	PZ	1	107,30
014 151 040	H 770 x L 550 Inter.500 Wat 610	PZ	1	106,60
014 151 041	H 770 x L 600 Inter.550 Wat 660	PZ	1	112,30
014 151 042	H 1200 x L 450 Inter.400 Wat 758	PZ	1	134,80
014 151 043	H 1200 x L 500 Inter.450 Wat 878	PZ	1	138,20
014 151 044	H 1200 x L 550 Inter.500 Wat 598	PZ	1	147,40
014 151 045	H 1200 x L 600 Inter.550 Wat 968	PZ	1	150,60
014 151 046	H 1500 x L 450 Inter.400 Wat 979	PZ	1	163,60
014 151 047	H 1500 x L 500 Inter.450 Wat 1071	PZ	1	167,70
014 151 048	H 1500 x L 550 Inter.500 Wat 1163	PZ	1	169,60
014 151 010	H 1500 x L 600 Inter.550 Wat 1254	PZ	1	176,30
014 151 050	H 1800 x L 450 Inter.400 Wat 1133	PZ	1	187,30
014 151 051	H 1800 x L 500 Inter.450 Wat 1239	PZ	1	194,10
014 151 052	H 1800 x L 550 Inter.500 Wat 1344	PZ	1	199,70
014 151 053	H 1800 x L 600 Inter.550 Wat 1450	PZ	1	204,80

Termoarredo
Curvo Round
Tubo 22
Radox Bianco



SETTORE 014

RISCALDAMENTO

CODICE	MISURA	UM	PZ	€
014 151 201	H 800 x L 450 Inter.400 Wat 400	PZ	1	90,10
014 151 202	H 800 x L 500 Inter.450 Wat 440	PZ	1	91,80
014 151 203	H 800 x L 550 Inter.500 Wat 480	PZ	1	94,60
014 151 204	H 800 x L 600 Inter.550 Wat 500	PZ	1	95,80
014 151 210	H 1200 x L 450 Inter.400 Wat 550	PZ	1	115,40
014 151 211	H 1200 x L 500 Inter.450 Wat 600	PZ	1	118,10
014 151 212	H 1200 x L 550 Inter.500 Wat 720	PZ	1	121,20
014 151 213	H 1200 x L 600 Inter.550 Wat 750	PZ	1	123,00
014 151 230	H 1500 x L 450 Inter.400 Wat 720	PZ	1	128,40
014 151 231	H 1400 x L 500 Inter.450 Wat 780	PZ	1	131,80
014 151 232	H 1400 x L 550 Inter.500 Wat 860	PZ	1	135,50
014 151 233	H 1400 x L 600 Inter.550 Wat 900	PZ	1	138,80
014 151 240	H 1720 x L 450 Inter.400 Wat 865	PZ	1	146,40
014 151 241	H 1720 x L 500 Inter.450 Wat 940	PZ	1	150,20
014 151 242	H 1720 x L 550 Inter.500 Wat 1030	PZ	1	154,80
014 151 243	H 1720 x L 600 Inter.550 Wat 1080	PZ	1	158,60

Termoarredo
Curvo Round
Tubo 22
Radox Cromato





Termoarredo Lisa
Tubo 22
H1200
Bianco Cordivari

CODICE	MISURA	UM	PZ	€
014 109 010	H1160L400I350 Wat 408	PZ	1	89,40
014 109 011	H1160L450I400 Wat 448	PZ	1	93,10
014 109 012	H1160L500I450 Wat 487	PZ	1	96,90
014 109 013	H1160L550I500 Wat 526	PZ	1	107,70
014 109 014	H1160L600I550 Wat 565	PZ	1	115,50



Termoarredo Lisa
Tubo 22
H1400
Bianco Cordivari

CODICE	MISURA	UM	PZ	€
014 109 020	H1385L400I350 Wat 509	PZ	1	111,80
014 109 021	H1385L450I400 Wat 558	PZ	1	115,50
014 109 022	H1385L500I450 Wat 606	PZ	1	119,30
014 109 023	H1385L550I500 Wat 655	PZ	1	124,10
014 109 024	H1385L600I550 Wat 703	PZ	1	128,60



Termoarredo Lisa
Tubo 22
H1800
Bianco Cordivari

CODICE	MISURA	UM	PZ	€
014 109 030	H1732L400I350 Wat 634	PZ	1	130,50
014 109 031	H1732L450I400 Wat 695	PZ	1	134,20
014 109 032	H1732L500I450 Wat 756	PZ	1	140,20
014 109 033	H1732L550I500 Wat 817	PZ	1	142,10
014 109 034	H1732L600I550 Wat 878	PZ	1	149,20



CODICE	MISURA	UM	PZ	€
016 139 400	Lt 10 Sopra Lavello A360 x L360 x P298	PZ	1	135,20

Scaldacqua Elettrico
Garanzia 2 Anni Chaffoteaux



CODICE	MISURA	UM	PZ	€
016 139 403	Lt 15 Sopra Lavello A360 x L360 x P346	PZ	1	148,70

Scaldacqua Elettrico
Garanzia 2 Anni Chaffoteaux



CODICE	MISURA	UM	PZ	€
016 139 401	Lt 10 Sotto Lavello A360 x L360 x P298	PZ	1	142,00

Scaldacqua Elettrico
Garanzia 2 Anni Chaffoteaux



CODICE	MISURA	UM	PZ	€
016 139 405	Lt 30 Sopra Lavello A447 x L447 x P410	PZ	1	172,80

Scaldacqua Elettrico
Garanzia 2 Anni Chaffoteaux



CODICE	MISURA	UM	PZ	€
016 139 410	Lt 50 Verticale A573 x L450 x P480	PZ	1	201,60

Scaldacqua Elettrico
Garanzia 2 Anni Chaffoteaux



CODICE	MISURA	UM	PZ	€
016 139 411	Lt 80 Verticale A773 x L450 x P480	PZ	1	202,60

Scaldacqua Elettrico
Garanzia 2 Anni Chaffoteaux



CODICE	MISURA	UM	PZ	€
016 139 413	Lt 80 Orizzontale A750 x L450 x P480	PZ	1	261,50

Scaldacqua Elettrico
Garanzia 2 Anni Chaffoteaux





Scaldacqua Elettrico
Garanzia 5 Anni Chaffoteaux

CODICE	MISURA	UM	PZ	€
016 139 440	Lt 10 Sopra Lavello A360 x L360 x P298	PZ	1	161,60



Scaldacqua Elettrico
Garanzia 5 Anni Chaffoteaux

CODICE	MISURA	UM	PZ	€
016 139 443	Lt 15 Sopra Lavello A360 x L360 x P346	PZ	1	161,60



Scaldacqua Elettrico
Garanzia 5 Anni Chaffoteaux

CODICE	MISURA	UM	PZ	€
016 139 441	Lt 10 Sotto Lavello A360 x L360 x P298	PZ	1	176,60



Scaldacqua Elettrico
Garanzia 5 Anni Chaffoteaux

CODICE	MISURA	UM	PZ	€
016 139 445	Lt 30 Sopra Lavello A447 x L447 x P410	PZ	1	236,40



Scaldacqua Elettrico
Garanzia 5 Anni Chaffoteaux

CODICE	MISURA	UM	PZ	€
016 139 450	Lt 50 Verticale A573 x L450 x P480	PZ	1	250,00



Scaldacqua Elettrico
Garanzia 5 Anni Chaffoteaux

CODICE	MISURA	UM	PZ	€
016 139 451	Lt 80 Verticale A773 x L450 x P480	PZ	1	251,40
016 139 452	Lt 80 Verticale A918 x L450 x P480	PZ	1	352,60

SETTORE 016

RISCALDAMENTO



CODICE	MISURA	UM	PZ	€
016 139 430	Lt 80 Verticale A750 x L450 x P480	PZ	1	328,50

Scaldacqua Termoelettrico
Garanzia 5 Anni Chaffoteaux
Destro



CODICE	MISURA	UM	PZ	€
016 139 431	Lt 80 Verticale A750 x L450 x P480	PZ	1	288,50

Scaldacqua Termoelettrico
Garanzia 5 Anni Chaffoteaux
Sinistro

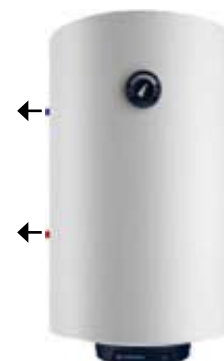

CODICE	MISURA	UM	PZ	€
016 073 011	Lt 80 Verticale A1360 x L350 x P350	PZ	1	611,50

Scaldacqua Legnaelettrico
Garanzia 2 Anni MRAVEGGI



CODICE	MISURA	UM	PZ	€
016 073 045	Lt 80 Orizzontale - Destro A715 x L420 x P445	PZ	1	408,80

Scaldacqua Termoelettrico
Garanzia 5 Anni RAVEGGI



CODICE	MISURA	UM	PZ	€
016 073 046	Lt 80 Orizzontale - Sinistro A715 x L420 x P445	PZ	1	408,80

Scaldacqua Termoelettrico
Garanzia 5 Anni RAVEGGI





Scaldacqua Gas
Istantaneo Camera Stagna
Avenir Plus

CODICE	MISURA	UM	PZ	€
016 139 210	Lt 11 A576 X L330 X P167 3632170	PZ	1	1040,20
016 139 211	Lt 11 A576 X L330 X P167 3632169	PZ	1	1040,20
016 139 218	Coassiale Orizzontale 60/100 L 1000 3318932	PZ	1	84,10



Scaldacqua Gas
Istantaneo Camera Stagna
Avenir Plus

CODICE	MISURA	UM	PZ	€
016 139 215	Lt 16 A600 X L369 X P167 3632174	PZ	1	1242,30
016 139 216	Lt 16 A600 X L369 X P167 3632173	PZ	1	1242,30
016 139 218	Coassiale Orizzontale 60/100 L 1000 3318932	PZ	1	84,10



Kit Scarico C&M Coassiale
Verticale Per Scaldino
Fluendo Plus Aspirato

CODICE	MISURA	UM	PZ	€
016 139 219	60/100 L 1000 - 3318645	PZ	1	84,10



Scaldacqua Gas
Istantaneo Camera Aperta
Avenir Outdoor

CODICE	MISURA	UM	PZ	€
016 139 300	Lt 11 Metano A563 X L350 X P130 3632345	PZ	1	1184,40
016 139 301	Lt 11 GPL A563 X L350 X P130 3632346	PZ	1	1267,00
016 139 305	Lt 16 Metano A563 X L350 X P130 3632347	PZ	1	1402,00
016 139 306	Lt 16 GPL A563 X L350 X P130 3632348	PZ	1	1279,90
016 139 307	Lt 20 Metano A582 X L375 X P160 3632349	PZ	1	1672,40
016 139 308	Lt 24 Metano A582 X L375 X P160 3632350	PZ	1	1980,50



Kit Trasformazione
Metano/Gpl Scaldacqua
Avenir Outdoor

CODICE	MISURA	UM	PZ	€
016 139 310	Lt 11 3632005	PZ	1	21,30
016 139 311	Lt 16 3632007	PZ	1	24,80
016 139 312	Lt 10/24 3632096	PZ	1	24,80



Scaldacqua Gas
Basamento
Accensione Fiamma Pilota
Gpl Coterm

CODICE	MISURA	UM	PZ	€
016 073 004	Lt 400 Coterm 3105	PZ	1	2748,40
016 073 005	Lt 400 Coterm 3304	PZ	1	3879,80



Scaldacqua Elettrico
Basamento

CODICE	MISURA	UM	PZ	€
016 073 012	Lt 500 V 220 Potenza Wat 5000	PZ	1	2482,30

SETTORE 016

RISCALDAMENTO



CODICE	MISURA	UM	PZ	€
016 139 019	LT 11 Metano A580 X L310 X P210 3632221	PZ	1	473,10
016 139 020	LT 11 GPL A580 X L310 X P210 3632220	PZ	1	473,10
016 139 024	Kit di Trasformazione per Lt 11 Metano/Gpl 3632067	PZ	1	50,60
016 139 025	Kit di Trasformazione per Lt 11 GPL/Metano 3632066	PZ	1	50,60

Scaldacqua Gas
Istantaneo Camera Aperta
Fluendo Plus Ont B



CODICE	MISURA	UM	PZ	€
016 139 021	LT 14 Metano A580 X L370 X P210 3632223	PZ	1	611,10
016 139 022	LT 14 GPL A580 X L370 X P230 3632222	PZ	1	575,10
016 139 024	Kit di Trasformazione per Lt 14 Metano/Gpl 3632067	PZ	1	50,60
016 139 025	Kit di Trasformazione per Lt 14 GPL/Metano 3632066	PZ	1	50,60

Scaldacqua Gas
Istantaneo Camera Aperta
Fluendo Plus Ont B



CODICE	MISURA	UM	PZ	€
016 139 012	LT 16 Metano A580 X L310 X P210 3632225	PZ	1	660,00
016 139 013	LT 16 GPL A580 X L370 X P230 3632224	PZ	1	660,00

Scaldacqua Gas
Istantaneo Camera Aperta
Fluendo Plus Ont B



CODICE	MISURA	UM	PZ	€
016 139 015	Lt 11 Metano - 3632221	PZ	0	420,50
016 139 016	Lt 11 GPL - 3632222	PZ	0	420,50
016 139 023	Lt 14 Metano - 3632323	PZ	0	466,20
016 139 026	Lt 14 GPL - 3632324	PZ	0	461,30

Scaldacqua Gas
Istantaneo Camera Aperta
BRD OMN



CODICE	MISURA	UM	PZ	€
016 139 017	LT 11 Metano A580 X L310 X P210 3632233	PZ	1	414,40
016 139 018	LT 11 GPL A580 X L370 X P230 3632232	PZ	1	414,40
016 139 024	Kit di Trasformazione per Lt 11 Metano/Gpl 3632067	PZ	1	50,60
016 139 025	Kit di Trasformazione per Lt 11 GPL/Metano 3632066	PZ	1	50,60

Scaldacqua Gas
Istantaneo Camera Aperta
Fluendo Plus Ont C



CODICE	MISURA	UM	PZ	€
016 139 027	LT 16 Metano A580 X L310 X P210 3632237	PZ	1	522,20
016 139 028	LT 16 GPL A580 X L370 X P230 3632236	PZ	1	522,20
016 139 024	Kit di Trasformazione per Lt 16 Metano/Gpl 3632067	PZ	1	50,60

Scaldacqua Gas
Istantaneo Camera Aperta
Fluendo Plus Ont C



SETTORE 016
RISCALDAMENTO



Caldaia a Condensazione
Urbia Green
Metano predisposizione Gpl

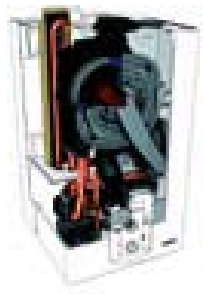

CODICE	MISURA	UM	PZ	€
016 139 160	25 Kw FF Metano/Gpl C/kit Fumi 3310024+kit 3318073	PZ	1	3431,60
016 139 161	30 Kw FF Metano/Gpl C/kit Fumi 3310238+kit 3318073	PZ	1	3752,50
016 139 162	35 Kw FF Metano/Gpl C/kit Fumi 3310026+kit 3318073	PZ	1	4081,00
016 139 163	Link 35 Kw FF Metano/Gpl Solo Caldaia 3310026	PZ	0	4764,90



Caldaia a Condensazione
Pigma Green
Metano predisposizione Gpl

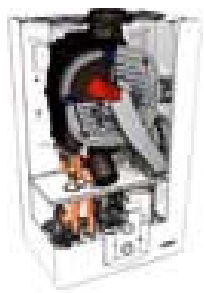

CODICE	MISURA	UM	PZ	€
016 139 150	25 Kw FF Metano/Gpl C/kit Fumi 3310399+kit3318073	PZ	1	2978,30
016 139 151	30 Kw FF Metano/Gpl C/kit Fumi 3310402+kit3318073	PZ	1	3374,70
016 139 153	35 Kw FF Metano/Gpl C/kit Fumi 3310401+kit3318073	PZ	1	3994,20



CODICE	MISURA	UM	PZ	€
016 139 155	Caldaia a Condensazione Pigma Green EXT 25 Kw 3310443 Metano/Gpl + Kit Fumi 3318073	PZ	1	2975,00

Caldaia a Condensazione
Pigma Green EXT
Metano predisposizione Gpl



CODICE	MISURA	UM	PZ	€
016 139 152	Caldaia a Condensazione Pigma Green L 30 Kw 3310402 Metano/Gpl + Kit Fumi 3318073	PZ	1	4019,70

Caldaia a Condensazione
Pigma Green L
Metano predisposizione Gpl



SETTORE 016
RISCALDAMENTO



Caldaia a Condensazione
Niagara Green C
Accumulo 40 Lt.
Metano predisposizione Gpl



CODICE	MISURA	UM	PZ	€
016 139 177	35 Kw Metano/Gpl Con kit Fumi 3318073	3310337	PZ	1

SETTORE 016
RISCALDAMENTO



Caldaia a Condensazione
Serelia Green
Accumulo 25 Lt.
Metano predisposizione Gpl

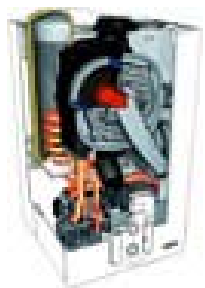

CODICE	MISURA	UM	PZ	€
016 139 174	25 Kw FF Metano/Gpl C/kit Fumi 3310403+Kit 3318073	PZ	1	4675,70



005,20

CODICE	MISURA	UM	PZ	€
016 139 125	25 Kw FF Metano/Gpl C/kit Fumi 3310444+Kit 3318073	PZ	1	3347,00

Caldaia a Condensazione
Pigma Green IN
Metano predisposizione Gpl



CODICE	MISURA	UM	PZ	€
016 139 123	25 Kw FF Metano/Gpl C/kit Fumi 3310442+kit 3318073	PZ	1	3786,70

Caldaia a Condensazione
Alixia Green IN
Metano predisposizione Gpl



CODICE	MISURA	UM	PZ	€
016 139 067	Universale per tutta la gamma 3318398	PZ	1	201,90

Cassone Unità Incasso
in Lamiera Chaffoteaux



SETTORE 016

RISCALDAMENTO



Caldaia a Condensazione
Inoa Green
Metano predisposizione Gpl



CODICE	MISURA	UM	PZ	€
016 139 140	24 Kw FF Gpl (Solo Caldaia) 3310449	PZ	1	2134,10
016 139 143	24 Kw FF Gpl 3310449 C/kit Fumi 3318073	PZ	1	2217,00
016 139 141	29 Kw FF Gpl (Solo Caldaia) 3310448	PZ	1	2489,40
016 139 144	29 Kw FF Gpl 3310448 C/kit Fumi 3318073	PZ	1	2538,40



Caldaia a Condensazione
CX Green
Metano predisposizione Gpl



CODICE	MISURA	UM	PZ	€
016 139 139	24 Kw FF Gpl (Solo Caldaia) 3310559	PZ	0	1973,70
016 139 138	24 Kw FF Gpl 3310559 C/kit Fumi 3318073	PZ	0	1969,60



Caldaia a Condensazione
CX Green
Metano predisposizione Gpl



CODICE	MISURA	UM	PZ	€
016 139 139	29 Kw FF Gpl (Solo Caldaia) 3310560	PZ	1	2501,90
016 139 138	29 Kw FF Gpl 3310560 Con kit Fumi 3318073	PZ	1	2583,20



CODICE	MISURA	UM	PZ	€
016 139 158	24 Kw CF Metano 3310440	PZ	1	1986,40
016 139 159	30 Kw CF Metano 3310441	PZ	1	2306,80

Caldaia a Camera Aperta
Pigma CF Metano
Chaffoteaux



CODICE	MISURA	UM	PZ	€
016 139 175	24 Kw CF Metano 3310492	PZ	1	1488,30

Caldaia a Camera Aperta
Alixia S CF Metano
Chaffoteaux





Kit Trasformazione GPL
Caldaia Condensazione

CODICE	MISURA	UM	PZ	€
016 139 113	25 Kw 3678345	PZ	1	16,50
016 139 114	30 Kw 3678346	PZ	1	16,50
016 139 115	35 Kw 3678347	PZ	1	16,50



Kit Coassiale per
Condensazione Completo
di Curva

CODICE	MISURA	UM	PZ	€
016 139 047	D.60/100 L 1000 3318073	PZ	1	63,10



Kit Scarico Coassiale
Partenza Verticale

CODICE	MISURA	UM	PZ	€
016 139 108	D.60/100-80 3318079	PZ	1	48,90
016 139 045	D.60/100-80/125 3318095	PZ	1	57,90



Kit Adattatore Scarico
Sdoppiato Partenza Verticale

CODICE	MISURA	UM	PZ	€
016 139 118	D.60/100-80 3318369	PZ	1	24,80



Kit Adattatore Scarico
Sdoppiato Partenza Verticale

CODICE	MISURA	UM	PZ	€
016 139 189	D.60/100-80/125 3580784	PZ	1	94,10



Prolunga Coassiale
Concentrica per Condens.

CODICE	MISURA	UM	PZ	€
016 139 104	D.60/100 L 1000 3318077	PZ	1	74,30
016 139 079	D.60/100 L 500 3318078	PZ	1	49,60



Curva Coassiale
per Condensazione

CODICE	MISURA	UM	PZ	€
016 139 095	D.60/100 a 45° 3318076	PZ	1	53,70



Tubo Prolunga
per Condensazione

CODICE	MISURA	UM	PZ	€
016 139 200	D.80 x L 1000 PPS 3318086	PZ	1	46,70
016 139 201	D.80 x L 500 PPS 3318087	PZ	1	26,30



Curva 90°
per Condensazione
Largo Raggio PPS

CODICE	MISURA	UM	PZ	€
016 139 187	D.80 M/F Largo Raggio PPS 3318084	PZ	1	37,90



Curva 45°
per Condensazione
Largo Raggio PPS

CODICE	MISURA	UM	PZ	€
016 139 188	D.80 M/F Largo Raggio PPS 3318085	CF	1	70,20



CODICE	MISURA	UM	PZ	€
016 010 021	D.80 MF L 1000 mm	PZ	1	11,00

Tubo Polipropilene PP Bianco Condensazione



CODICE	MISURA	UM	PZ	€
016 010 022	D.80 MF L 500 mm	PZ	1	7,00

Tubo Polipropilene PP Bianco Condensazione



CODICE	MISURA	UM	PZ	€
016 010 023	D.80 M/F	PZ	1	6,60

Gomito 87° Polipropilene PP Bianco Condensazione



CODICE	MISURA	UM	PZ	€
016 010 025	D.80 M/F	PZ	1	17,00

Gomito 30° Polipropilene PP Bianco Condensazione



CODICE	MISURA	UM	PZ	€
016 010 026	D.80 M/F	PZ	1	6,10

Gomito 45° Polipropilene PP Bianco Condensazione



CODICE	MISURA	UM	PZ	€
016 010 027	D.80 M/F	PZ	1	30,50

Gomito 87° Polipropilene PP Bianco Condensazione Con Tappo Is



CODICE	MISURA	UM	PZ	€
016 010 028	D.80 M/F	PZ	1	15,90

Tee 93° Polipropilene PP Bianco Condensazione



CODICE	MISURA	UM	PZ	€
016 010 029	D.80 M/F	PZ	1	29,30

Tee 93° Polipropilene PP Bianco Condensazione Con Tappo Condensa



CODICE	MISURA	UM	PZ	€
016 010 030	D.80 M/F	PZ	1	10,00

Raccordo Ispezione Polipropilene PP Bianco Condensazione





Kit Trasformazione GPL
per Caldaia Convenzionale

CODICE	MISURA	UM	PZ	€
016 139 117	25 Kw 3318261	PZ	1	31,90
016 139 116	25 Kw 3318264	PZ	1	30,90

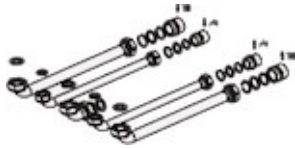

Kit Idraulico per Cantiere
per Tutta la Gamma

CODICE	MISURA	UM	PZ	€
016 139 109	Cantiere per tutta la Gamma 3318222	PZ	1	43,40

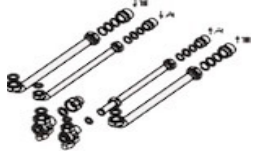

Kit Idraulico + 2 Rubinetti
per Tutta la Gamma

CODICE	MISURA	UM	PZ	€
016 139 111	per Tutta la Gamma 3318224	PZ	1	60,90



Kit Idraulico
Tutta la Gamma

CODICE	MISURA	UM	PZ	€
016 139 112	Kit Idraulico	PZ	1	145,50



Kit Idraulico + 2 Rubinetti
per Caldaie Incasso

CODICE	MISURA	UM	PZ	€
016 139 072	per Caldaie Incasso 3318186	PZ	1	57,50



Kit Idraulico + 4 Rubinetti
per Caldaie Incasso

CODICE	MISURA	UM	PZ	€
016 139 089	per Caldaie Incasso 3318185	PZ	1	95,30



Kit Gestione Sistemi Solari
a Circolazione Forzata non
Motorizzato

CODICE	MISURA	UM	PZ	€
016 139 098	Chaffoteaux cod.3318348	PZ	1	251,70



Expert Control Gestione
Sistema Modulante C/Filo
Chaffoteaux

CODICE	MISURA	UM	PZ	€
016 139 037	Chaffoteaux 3318870	PZ	1	281,20

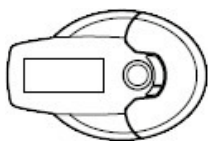

Cronotermostato Chaffoteaux
Settimanale Wred con Fili

CODICE	MISURA	UM	PZ	€
016 139 038	Chaffoteaux cod.3318301	PZ	1	120,60



Vaso Espansione Sanitario
0,2 Lt Chaffoteaux

CODICE	MISURA	UM	PZ	€
016 139 051	Chaffoteaux cod.3678430	PZ	1	49,00



Kit Coassiale
per Convenzionale
con Curva D.60/100

CODICE	MISURA	UM	PZ	€
016 139 099	Chaffoteaux cod.3318000	PZ	1	50,50
016 139 041	Chaffoteaux cod.3318001	PZ	1	88,90



Kit Coassiale
per Convenzionale
Verticale D.60/100

CODICE	MISURA	UM	PZ	€
016 139 315	Chaffoteaux cod.3318002	PZ	1	96,50



CODICE	MISURA	UM	PZ	€
016 139 106	Chaffoteaux cod.3318367	PZ	1	26,50

Adattatore per Sistemi Sdoppiati Convenzionale D.60/100



CODICE	MISURA	UM	PZ	€
016 139 060	Chaffoteaux cod.3318368	PZ	1	148,10

Kit Sistemi Sdoppiati con Tubi Convenzionale D.80



CODICE	MISURA	UM	PZ	€
016 139 059	Chaffoteaux cod.3318187	PZ	1	27,10

Kit Scarico Frontale Pretranciato per Caldaie Incasso



CODICE	MISURA	UM	PZ	€
016 139 039	Chaffoteaux cod.3318005	PZ	1	64,80
016 139 105	Chaffoteaux cod.3318006	PZ	1	43,20
016 139 107	Chaffoteaux cod.3318007	PZ	1	29,10

Prolunga Coassiale Concetrica per Convenzionale D.60/1000 MF



CODICE	MISURA	UM	PZ	€
016 139 096	Chaffoteaux cod.3318003	PZ	1	46,10

Curva Gomito 90° per Convenzionale D.80 M/F Largo Raggio



CODICE	MISURA	UM	PZ	€
016 139 097	Chaffoteaux cod.3318004	PZ	1	94,10

Curva Gomito 45° per Convenzionale D.80 M/F Largo Raggio

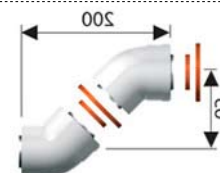

CODICE	MISURA	UM	PZ	€
016 139 183	Inox D.80	PZ	1	19,00

Terminale di Scarico Convenzionale



CODICE	MISURA	UM	PZ	€
016 139 184	Plastica D.80	PZ	1	7,30

Terminale di Scarico Convenzionale



CODICE	MISURA	UM	PZ	€
016 139 182	Chaffoteaux cod.3318435	PZ	1	111,90

Kit Idraulico + 4 Rubinetti per Caldaie Niagara C Green



CODICE	MISURA	UM	PZ	€
016 139 181	Chaffoteaux D.80 D.60/80/100 cod.3318435	PZ	1	231,40

Terminale di Scarico Convenzionale Nero a Tetto



CODICE	MISURA	UM	PZ	€
016 139 180	Chaffoteaux cod.3318009	PZ	1	85,00

Tegola Inclinata 12°-40° per Camino Nero D.125





SETTORE 016
RISCALDAMENTO



Tubo Verniciato Bianco
Convenzionale

CODICE	MISURA	UM	PZ	€
016 010 001	D.80 MF L 1000	PZ	1	21,00



Tubo Verniciato Bianco
Convenzionale

CODICE	MISURA	UM	PZ	€
016 010 002	D.80 MF L 500	PZ	1	16,50



Gomito 90° Verniciato
Bianco Convenzionale

CODICE	MISURA	UM	PZ	€
016 010 003	D.80 F/F	PZ	1	18,80



Gomito 90° Verniciato
Bianco Convenzionale

CODICE	MISURA	UM	PZ	€
016 010 004	D.80 M/F	PZ	1	16,10



Gomito 45° Verniciato
Bianco Convenzionale

CODICE	MISURA	UM	PZ	€
016 010 005	D.80 F/F	PZ	1	18,70



Gomito 45° Verniciato
Bianco Convenzionale

CODICE	MISURA	UM	PZ	€
016 010 006	D.80 M/F	PZ	1	15,40



Griglia Terminale
di Aspirazione Femmina
Verniciata

CODICE	MISURA	UM	PZ	€
016 010 010	Verniciata Nero D.80	PZ	1	7,10



Griglia Terminale di Scarico
Femmina Verniciata

CODICE	MISURA	UM	PZ	€
016 010 011	Verniciata Nero D.80	PZ	1	7,60



Rosone Coprimuro
Verniciata

CODICE	MISURA	UM	PZ	€
016 010 015	Verniciata Bianco D.80	PZ	1	8,20



CODICE	MISURA	UM	PZ	€
019 018 001	D.3/8x10	PZ	10	1,80
019 018 276	D.3/8x12	PZ	10	2,20
019 018 275	D.3/8x14	PZ	10	2,20
019 018 002	D.1/2x10	PZ	10	2,20
019 018 003	D.1/2x12	PZ	10	2,30
019 018 004	D.1/2x14	PZ	10	2,60
019 018 007	D.3/4x14	PZ	10	3,30
019 018 005	D.1/2x16	PZ	10	2,90
019 018 008	D.3/4x16	PZ	10	3,50
019 018 006	D.1/2x18	PZ	10	3,50
019 018 009	D.3/4x18	PZ	10	3,50
019 018 011	D.1"x18	PZ	10	5,70
019 018 010	D.3/4x22	PZ	10	5,50
019 018 012	D.1"x22	PZ	10	6,30

Raccordo Tubo Rame
con Ogiva O-Ring
Diritto Maschio



CODICE	MISURA	UM	PZ	€
019 018 013	D.3/8x10	PZ	10	1,30
019 018 014	D.1/2x10	PZ	10	2,40
019 018 015	D.1/2x12	PZ	10	2,60
019 018 016	D.1/2x14	PZ	10	3,00
019 018 019	D.3/4x14	PZ	10	3,60
019 018 017	D.1/2x16	PZ	10	3,20
019 018 020	D.3/4x16	PZ	10	3,50
019 018 018	D.1/2x18	PZ	10	3,50
019 018 021	D.3/4x18	PZ	10	4,10
019 018 023	D.1"x18	PZ	10	6,40
019 018 022	D.3/4x22	PZ	10	5,50
019 018 024	D.1"x22	PZ	10	7,50

Raccordo Tubo Rame
con Ogiva O-Ring
Diritto Femmina



CODICE	MISURA	UM	PZ	€
019 018 025	D.10x10	PZ	10	3,00
019 018 026	D.12x12	PZ	10	3,80
019 018 027	D.14x14	PZ	10	4,10
019 018 028	D.16x16	PZ	10	4,60
019 018 029	D.18x18	PZ	10	4,80
019 018 030	D.22x22	PZ	10	7,40

Raccordo per Tubo Rame
con Ogiva O-Ring
Diritto Doppio



CODICE	MISURA	UM	PZ	€
019 018 031	D.1/2x12	PZ	10	4,70
019 018 032	D.14x14	PZ	10	4,80
019 018 033	D.16x16	PZ	10	5,90
019 018 034	D.18x18	PZ	10	6,70
019 018 035	D.22x22	PZ	10	10,20

Raccordo per Tubo Rame
con Ogiva O-Ring
Gomito Doppio



CODICE	MISURA	UM	PZ	€
019 018 036	D.1/2x12	PZ	10	3,80
019 018 037	D.1/2x14	PZ	10	4,10
019 018 040	D.3/4x14	PZ	10	4,70
019 018 038	D.1/2x16	PZ	10	4,30
019 018 041	D.3/4x16	PZ	10	4,90
019 018 039	D.1/2x18	PZ	10	5,50
019 018 042	D.3/4x18	PZ	10	5,60
019 018 043	D.3/4x22	PZ	10	8,20
019 018 044	D.1"x22	PZ	10	12,60

Raccordo per Tubo Rame
con Ogiva O-Ring
Gomito Femmina





Raccordo per Tubo Rame
con Ogiva O-Ring
Gomito Maschio

CODICE	MISURA	UM	PZ	€
019 018 045	D.1/2x12	PZ	10	3,60
019 018 046	D.1/2x14	PZ	10	3,70
019 018 049	D.3/4x14	PZ	10	6,60
019 018 047	D.1/2x16	PZ	10	3,90
019 018 050	D.3/4x16	PZ	10	6,70
019 018 048	D.1/2x18	PZ	10	5,90
019 018 051	D.3/4x18	PZ	10	7,10
019 018 052	D.3/4x22	PZ	10	10,70
019 018 053	D.1"x22	PZ	10	12,40



Raccordo per Tubo Rame
con Ogiva O-Ring
Tee 3 Dadi

CODICE	MISURA	UM	PZ	€
019 018 054	D.12x12x12 1/2	PZ	10	5,90
019 018 055	D.14x14x14 1/2	PZ	10	6,10
019 018 056	D.16x16x16 1/2	PZ	10	8,20
019 018 057	D.18x18x18 3/4	PZ	10	10,30
019 018 058	D.22x22x22 3/4	PZ	10	13,80



Raccordo per Tubo Rame
con Ogiva O-Ring
Tee Femmina

CODICE	MISURA	UM	PZ	€
019 018 059	D.12x1/2x12	PZ	10	6,10
019 018 060	D.14x1/2x14	PZ	10	5,90
019 018 061	D.16x1/2x16	PZ	10	6,30
019 018 062	D.18x3/4x18	PZ	10	8,30
019 018 063	D.22x3/4x22	PZ	10	13,20



Raccordo per Tubo Rame
con Ogiva O-Ring
Gomito Femmina con Flangia

CODICE	MISURA	UM	PZ	€
019 018 064	D.1/2x12	PZ	10	4,90
019 018 065	D.1/2x14	PZ	10	5,90
019 018 101	D.1/2x16	PZ	10	6,10



O-Ring Giallo Gas
per Tubo Rame OR

CODICE	MISURA	UM	PZ	€
001 001 795	O-Ring Giallo D.12	PZ	10	0,50
001 001 796	O-Ring Giallo D.14	PZ	10	0,50
001 001 797	O-Ring Giallo D.16	PZ	10	0,50
001 001 798	O-Ring Giallo D.18	PZ	10	0,60
001 001 799	O-Ring Giallo D.22	PZ	10	1,00



Rondella Piana Elastica
per Raccordi Tubo Rame OR

CODICE	MISURA	UM	PZ	€
019 018 066	Rondella Piana D.10	PZ	10	0,10
019 018 067	Rondella Piana D.12	PZ	10	0,10
019 018 068	Rondella Piana D.14	PZ	10	0,10
019 018 069	Rondella Piana D.16	PZ	10	0,20
019 018 070	Rondella Piana D.18	PZ	10	0,20
019 018 071	Rondella Piana D.22	PZ	10	0,30
019 018 072	Anello Elastico D.10	PZ	10	0,20
019 018 073	Anello Elastico D.12	PZ	10	0,20
019 018 074	Anello Elastico D.14	PZ	10	0,20
019 018 075	Anello Elastico D.16	PZ	10	0,20
019 018 076	Anello Elastico D.18	PZ	10	0,20
019 018 077	Anello Elastico D.22	PZ	10	0,30
019 018 078	O-Ring di Tenuta D.10	PZ	10	0,20
019 018 079	O-Ring di Tenuta D.12	PZ	10	0,30
019 018 080	O-Ring di Tenuta D.14	PZ	10	0,30
019 018 081	O-Ring di Tenuta D.16	PZ	10	0,90
019 018 082	O-Ring di Tenuta D.18	PZ	10	0,40
019 018 083	O-Ring di Tenuta D.22	PZ	10	0,70



CODICE	MISURA	UM	PZ	€
019 017 092	D.1/2x12 Foro 16	PZ	10	1,10
019 017 093	D.1/2x14 Foro 16	PZ	10	1,10

Ogiva Monocono in Teflon per Collettori



CODICE	MISURA	UM	PZ	€
019 017 088	D.1/2x12	PZ	10	0,80
019 017 089	D.1/2x14	PZ	10	0,90
019 017 090	D.16x1/2	PZ	10	0,60
019 017 266	D.3/4x16	PZ	10	0,80
019 017 091	D.1/2x18	PZ	10	0,70
019 017 113	D.3/4x18	PZ	10	0,90
019 017 114	D.3/4x22	PZ	10	1,20

Dado Ottone Giallo



CODICE	MISURA	UM	PZ	€
019017095	Dado Ottone Giallo +Ogiva Monocono in Teflon per Collettori D.1/2x12	PZ	10	2,10
019017096	Dado Ottone Giallo +Ogiva Monocono in Teflon per Collettori D.1/2x14	PZ	10	2,10

Dado Ottone Giallo con Ogiva Monocono in Teflon per Collettori D.1/2x12



CODICE	MISURA	UM	PZ	€
019 041 080	D.1/2x12	PZ	10	0,40
019 041 081	D.1/2x14	PZ	10	0,50
019 041 082	D.1/2x16	PZ	10	0,40
019 041 196	D.3/4x16	PZ	10	0,70
019 041 083	D.3/4x18	PZ	10	0,60
019 041 197	D.18	PZ	10	0,30
019 041 198	D.22	PZ	10	0,60

Anello Ogiva Bicono in Teflon per Raccordi Tubo Rame



CODICE	MISURA	UM	PZ	€
019 041 079	D.1/2x12	PZ	10	0,50
019 041 161	D.1/2x14	PZ	10	0,40
019 041 199	D.1/2x16	PZ	10	0,50
019 041 200	D.3/4x16	PZ	10	0,30
019 041 201	D.18	PZ	10	0,40
019 041 202	D.3/4x18	PZ	10	0,60
019 041 203	D.3/4x22	PZ	10	0,70

Anello Ogiva Bicono in Ottone per Raccordi Tubo Rame



CODICE	MISURA	UM	PZ	€
019 041 041	D.1/2x10	PZ	10	0,50
019 041 143	D.12	PZ	10	0,50
019 041 158	D.14	PZ	10	0,60
019 041 148	D.16	PZ	10	0,70
019 041 194	D.18	PZ	10	0,90
019 041 262	D.22	PZ	10	1,10

Bussolotto in Ottone per Raccordi Tubo Rame





Raccordo Doppio
per Tubo Rame Gas Clima

CODICE	MISURA	UM	PZ	€
019 018 085	D.1/4 x6x1/4	PZ	10	3,40
019 018 086	D.3/8x10x3/8	PZ	10	5,50
019 018 087	D.1/2x12x1/2	PZ	10	7,60
019 018 088	D.5/8x16x5/8	PZ	10	4,40



Raccordo Dado
Calotta Ottone Giallo
per Tubo Rame Gas Clima

CODICE	MISURA	UM	PZ	€
019 018 090	D.1/4	PZ	10	1,10
019 018 091	D.3/8	PZ	10	1,60
019 018 092	D.1/2	PZ	10	2,30
019 018 093	D.5/8	PZ	10	2,40



Raccordo Autocartellante
per Tubo Rame Gas Clima

CODICE	MISURA	UM	PZ	€
012 015 100	D.1/4 x6	PZ	10	9,20
012 015 101	D.3/8x10	PZ	10	10,30



Lega Saldante Argentana

CODICE	MISURA	UM	PZ	€
019 017 094	Kg 1 Argento al 5%	KG	1	99,20



Lega Saldante Stagno
con Argento a Filo

CODICE	MISURA	UM	PZ	€
019 041 152	Gr 500 Argento 5%	PZ	1	157,50
019 041 154	Gr 250 Argento 3%	PZ	1	111,10



Polvere Decapante
Saldante

CODICE	MISURA	UM	PZ	€
019 017 116	Coper Flux	PZ	1	23,20



Barrette di stagno

CODICE	MISURA	UM	PZ	€
019 041 156	Kg 1 Al 33%	KG	1	69,30
019 041 153	Kg 1 Al 40%	KG	1	90,70



CODICE	MISURA	UM	PZ	€
019 041 111	D.12 x 12	PZ	10	0,40
019 041 112	D.14 x 14	PZ	10	0,40
019 041 113	D.16 x 16	PZ	10	0,50
019 041 114	D.18 x 18	PZ	10	0,70
019 041 219	D.22 x 22	PZ	10	0,80
019 041 220	D.28 x 28	PZ	10	1,90
019 041 221	D.35 x 35	PZ	10	4,40

Raccordo in Rame a Saldare
Manicotto Dritto
Femmina Femmina



CODICE	MISURA	UM	PZ	€
019 041 094	D.12x10	PZ	10	2,30
019 041 089	D.14x10	PZ	10	0,90
019 041 325	D.14x12	PZ	10	0,90
019 041 090	D.16x12	PZ	10	1,10
019 041 091	D.16x14	PZ	10	0,90
019 041 092	D.18x12	PZ	10	2,50
019 041 095	D.18x16	PZ	10	1,60
019 041 207	D.18x14	PZ	10	1,40
019 041 208	D.22x18	PZ	10	2,40
019 041 209	D.28x22	PZ	10	3,70
019 041 288	D.35x28	PZ	10	13,40
019 041 263	D.35x18	PZ	10	14,30

Raccordo in Rame a Saldare
Manicotto Dritto Ridotto
Femmina Femmina



CODICE	MISURA	UM	PZ	€
019 041 222	D.12x10	PZ	10	1,50
019 041 115	D.14x10	PZ	10	1,20
019 041 223	D.14x12	PZ	10	0,70
019 041 116	D.16x12	PZ	10	1,20
019 041 117	D.16x14	PZ	10	1,00
019 041 118	D.18x12	PZ	10	2,30
019 041 119	D.18x14	PZ	10	1,50
019 041 120	D.18x16	PZ	10	1,30
019 041 293	D.22x12	PZ	10	4,60
019 041 292	D.22x14	PZ	10	2,60
019 041 291	D.22x16	PZ	10	1,80
019 041 224	D.22x18	PZ	10	1,60
019 041 225	D.28x22	PZ	10	3,70
019 041 283	D.35x18	PZ	10	16,80
019 041 226	D.35x22	PZ	10	10,90

Raccordo in Rame a Saldare
Manicotto Dritto Ridotto
Femmina Maschio



CODICE	MISURA	UM	PZ	€
019 041 096	D.12	PZ	10	1,70
019 041 097	D.14	PZ	10	1,80
019 041 098	D.16	PZ	10	2,00
019 041 264	D.18	PZ	10	1,40
019 041 266	D.22	PZ	10	2,10
019 041 265	D.28	PZ	10	3,90
019 041 267	D.35	PZ	10	10,70

Raccordo in Rame a Saldare
Tappo Femmina



CODICE	MISURA	UM	PZ	€
019 041 099	D.12x12x12	PZ	10	1,40
019 041 100	D.14x14x14	PZ	10	1,30
019 041 101	D.16x16x16	PZ	10	1,10
019 041 102	D.18x18x18	PZ	10	2,10
019 041 210	D.22x22x22	PZ	10	3,20
019 041 211	D.28x28x28	PZ	10	4,20
019 041 212	D.35x35x35	PZ	10	12,30

Raccordo in Rame a Saldare
Tee Femmina





Raccordo in Rame a Saldare
Gomito 45°
Femmina Femmina

CODICE	MISURA	UM	PZ	€
019 041 340	D.12 x 12	PZ	10	2,40
019 041 341	D.14 x 14	PZ	10	1,20
019 041 342	D.16 x 16	PZ	10	1,30
019 041 343	D.18 x 18	PZ	10	1,70
019 041 344	D.22 x 22	PZ	10	2,10
019 041 345	D.28 x 28	PZ	10	3,40
019 041 346	D.35 x 35	PZ	10	12,40



Raccordo in Rame a Saldare
Gomito 45°
Machio Femmina

CODICE	MISURA	UM	PZ	€
019 041 350	D.12 x 12	PZ	10	1,90
019 041 351	D.14 x 14	PZ	10	1,40
019 041 352	D.16 x 16	PZ	10	1,80
019 041 353	D.18 x 18	PZ	10	1,80
019 041 354	D.22 x 22	PZ	10	2,20
019 041 355	D.28 x 28	PZ	10	3,60
019 041 356	D.35 x 35	PZ	10	12,80



Raccordo in Rame a Saldare
Gomito 90°
Femmina Femmina

CODICE	MISURA	UM	PZ	€
019 041 103	D.12 x 12	PZ	10	1,00
019 041 104	D.14 x 14	PZ	10	0,70
019 041 105	D.16 x 16	PZ	10	0,80
019 041 106	D.18 x 18	PZ	10	1,00
019 041 213	D.22 x 22	PZ	10	1,40
019 041 214	D.28 x 28	PZ	10	2,70
019 041 215	D.35 x 35	PZ	10	10,00



Raccordo in Rame a Saldare
Gomito 90°
Maschio Femmina

CODICE	MISURA	UM	PZ	€
019 041 107	D.12 x 12	PZ	10	0,90
019 041 108	D.14 x 14	PZ	10	0,90
019 041 109	D.16 x 16	PZ	10	1,10
019 041 110	D.18 x 18	PZ	10	1,30
019 041 216	D.22 x 22	PZ	10	1,90
019 041 217	D.28 x 28	PZ	10	5,40
019 041 218	D.35 x 35	PZ	10	13,20



Raccordo in Rame a Saldare
Tee Ridotta Femmina

CODICE	MISURA	UM	PZ	€
019 017 107	D.14x12x14	PZ	10	2,10
019 041 253	D.16x12x16	PZ	10	2,00
019 041 254	D.16x14x16	PZ	10	2,40
019 041 255	D.22x18x22	PZ	10	2,20
019 041 256	D.22x16x22	PZ	10	3,50
019 041 258	D.28x18x28	PZ	10	9,80
019 041 257	D.28x22x28	PZ	10	6,90
019 041 261	D.35x18x35	PZ	10	25,70
019 041 260	D.35x22x35	PZ	10	10,00
019 041 259	D.35x28x35	PZ	10	22,60



Raccordo in Rame a Saldare
Curva Largo Raggio
Femmina Femmina

CODICE	MISURA	UM	PZ	€
019 041 050	D.12 x 12	PZ	10	1,10
019 041 051	D.14 x 14	PZ	10	1,00
019 041 052	D.16 x 16	PZ	10	1,30
019 041 053	D.18 x 18	PZ	10	1,30
019 041 054	D.22 x 22	PZ	10	1,90
019 041 055	D.28 x 28	PZ	10	3,20
019 041 056	D.35 x 35	PZ	10	8,20



CODICE	MISURA	UM	PZ	€
019 041 060	D.12 x 12	PZ	10	1,20
019 041 061	D.14 x 14	PZ	10	0,90
019 041 062	D.16 x 16	PZ	10	0,90
019 041 063	D.18 x 18	PZ	10	1,80
019 041 064	D.22 x 22	PZ	10	2,40
019 041 065	D.28 x 28	PZ	10	5,10
019 041 066	D.35 x 35	PZ	10	14,60

Raccordo in Rame a Saldare
Curva Largo Raggio
Maschio Femmina



CODICE	MISURA	UM	PZ	€
019 041 121	D.1/2 x12	PZ	10	3,30
019 041 122	D.1/2x14	PZ	10	3,30
019 041 227	D.3/4x14	PZ	10	3,10
019 041 123	D.1/2x16	PZ	10	3,30
019 041 125	D.1/2x16	PZ	10	5,50
019 041 228	D.1/2x18	PZ	10	2,80
019 041 124	D.3/4x18	PZ	10	4,30
019 041 330	D.1/2x22	PZ	10	4,80
019 041 229	D.3/4x22	PZ	10	5,00
019 041 289	D.1" x22	PZ	10	8,70
019 041 230	D.1" x28	PZ	10	9,60
019 041 270	D.1" x35	PZ	10	12,70
019 041 231	D.1"1/4x35	PZ	10	15,70

Raccordo in Bronzo a Saldare
Diritto Femmina



CODICE	MISURA	UM	PZ	€
019 041 126	D.1/2 x12	PZ	10	1,60
019 041 127	D.1/2x14	PZ	10	2,10
019 041 232	D.3/4x14	PZ	10	4,50
019 041 128	D.1/2x16	PZ	10	2,10
019 041 130	D.1/2x16	PZ	10	2,50
019 041 233	D.1/2x18	PZ	10	2,80
019 041 129	D.3/4x18	PZ	10	3,40
019 041 333	D.1/2x22	PZ	10	4,60
019 041 234	D.3/4x22	PZ	10	3,30
019 041 272	D.1" x22	PZ	10	5,70
019 041 235	D.1" x28	PZ	10	6,10
019 041 236	D.1"1/4x35	PZ	10	10,20

Raccordo in Bronzo a Saldare
Diritto Maschio



CODICE	MISURA	UM	PZ	€
019 041 131	D.1/2 x12	PZ	10	1,90
019 041 132	D.1/2x14	PZ	10	2,40
019 041 238	D.3/4x14	PZ	10	10,50
019 041 237	D.1/2x16	PZ	10	1,20
019 041 133	D.1/2x16	PZ	10	3,40
019 041 239	D.1/2x18	PZ	10	2,30
019 041 134	D.3/4x18	PZ	10	4,90
019 041 335	D.1/2x22	PZ	10	7,00
019 041 240	D.3/4x22	PZ	10	5,60
019 041 285	D.1" x22	PZ	10	10,80
019 041 241	D.1" x28	PZ	10	17,30
019 041 242	D.1"1/4x35	PZ	10	28,70

Raccordo in Bronzo a Saldare
Gomito Femmina



CODICE	MISURA	UM	PZ	€
019 041 135	D.1/2 x12	PZ	10	2,00
019 041 136	D.1/2 x14	PZ	10	3,60
019 041 137	D.1/2 x16	PZ	10	3,80

Raccordo in Bronzo a Saldare
Gomito Femmina Flangiato





Raccordo
in Bronzo a Saldare
Gomito Maschio

CODICE	MISURA	UM	PZ	€
019 041 243	D.1/2 x12	PZ	10	2,40
019 041 244	D.1/2x14	PZ	10	2,40
019 041 248	D.3/4x14	PZ	10	4,90
019 041 247	D.1/2x16	PZ	10	3,60
019 041 245	D.1/2x16	PZ	10	5,30
019 041 249	D.1/2x18	PZ	10	5,60
019 041 246	D.3/4x18	PZ	10	6,70
019 041 250	D.1/2x22	PZ	10	7,10
019 041 286	D.3/4x22	PZ	10	11,30
019 041 251	D.1" x28	PZ	10	13,90
019 041 252	D.1"1/4x35	PZ	10	24,30



Raccordo
in Bronzo a Saldare
Tee Femmina

CODICE	MISURA	UM	PZ	€
019 041 294	D.1/2x1/2x12	PZ	10	3,10
019 041 295	D.14x1/2x14	PZ	10	4,00
019 041 296	D.16x1/2x16	PZ	10	4,80
019 041 297	D.18x1/2x18	PZ	10	6,90
019 041 298	D.18x3/4x18	PZ	10	10,10
019 041 299	D.22x1/2x22	PZ	10	9,20
019 041 300	D.22x3/4x22	PZ	10	11,60
019 041 301	D.28x3/4x28	PZ	10	11,80
019 041 302	D.28x 1" x28	PZ	10	14,80



Raccordo
in Bronzo a Saldare
Giunto 3 Pz Maschio
Con Bocchettone

CODICE	MISURA	UM	PZ	€
019 041 273	D.1/2x12	PZ	10	13,10
019 041 274	D.1/2x14	PZ	10	12,10
019 041 275	D.1/2x16	PZ	10	7,10
019 041 276	D.1/2x18	PZ	10	8,50
019 041 281	D.3/4x18	PZ	10	16,20
019 041 282	D.3/4x22	PZ	10	15,40
019 041 271	D.1" x22	PZ	10	32,50
019 041 306	D.1" x28	PZ	10	27,90
019 041 307	D.1"1/4x35	PZ	10	31,90



Raccordo
in Bronzo a Saldare
Giunto 3 Pz Femmina
Con Bocchettone

CODICE	MISURA	UM	PZ	€
019 041 310	D.1/2x12	PZ	10	16,70
019 041 311	D.1/2x14	PZ	10	14,90
019 041 312	D.1/2x16	PZ	10	8,40
019 041 313	D.1/2x18	PZ	10	14,20
019 041 314	D.3/4x18	PZ	10	16,00
019 041 315	D.3/4x22	PZ	10	18,30
019 041 316	D.1" x28	PZ	10	27,30
019 041 317	D.1"1/4x35	PZ	10	50,20



Raccordo
in Bronzo a Saldare
Giunto 3 Pz Femmina
Con Bocchettone

CODICE	MISURA	UM	PZ	€
019 041 277	D.12x12	PZ	10	9,40
019 041 278	D.14x14	PZ	10	14,50
019 041 279	D.16x16	PZ	10	16,80
019 041 280	D.18x18	PZ	10	12,30
019 041 287	D.22x22	PZ	10	10,70
019 041 320	D.28x28	PZ	10	34,20



Raccordo
in Rame a Saldare
Girello Codulo
Femmina Femmina

CODICE	MISURA	UM	PZ	€
019 041 084	D.1/2x12	PZ	10	3,20
019 041 085	D.1/2x14	PZ	10	3,20
019 041 086	D.3/4x14	PZ	10	6,10
019 041 087	D.3/4x16	PZ	10	6,10
019 041 088	D.3/4x18	PZ	10	6,10
019 041 204	D.3/4x22	PZ	10	8,60
019 041 205	D.1"1/4x28	PZ	10	12,00



CODICE	MISURA	UM	PZ	€
019 042 001	D.12x12	PZ	10	3,90
019 042 002	D.15x15	PZ	10	3,50
019 042 003	D.18x18	PZ	10	5,10
019 042 004	D.22x22	PZ	10	6,20
019 042 005	D.28x28	PZ	10	10,70
019 042 006	D.35x35	PZ	10	13,30

Raccordo in Rame a Pressare
Manicotto Dritto
Femmina Femmina



CODICE	MISURA	UM	PZ	€
019 042 010	D.15x12	PZ	10	3,20
019 042 011	D.18x12	PZ	10	4,70
019 042 012	D.18x15	PZ	10	3,30
019 042 014	D.22x15	PZ	10	4,00
019 042 015	D.22x18	PZ	10	4,90
019 042 016	D.28x18	PZ	10	8,90
019 042 017	D.28x22	PZ	10	10,50
019 042 018	D.35x22	PZ	10	10,90
019 042 019	D.35x28	PZ	10	13,70

Raccordo in Rame a Pressare
Manicotto Ridotto
Maschio Femmina



CODICE	MISURA	UM	PZ	€
019 042 031	D.15	PZ	10	7,70
019 042 032	D.18	PZ	10	11,20
019 042 033	D.22	PZ	10	13,70
019 042 034	D.28	PZ	10	23,10
019 042 035	D.35	PZ	10	22,60

Raccordo in Rame a Pressare
Tappo Femmina



CODICE	MISURA	UM	PZ	€
019 042 040	D.12x12x12	PZ	10	7,00
019 042 041	D.15x15x15	PZ	10	6,10
019 042 042	D.18x18x18	PZ	10	9,50
019 042 043	D.22x22x22	PZ	10	12,30
019 042 044	D.28x28x28	PZ	10	19,10
019 042 045	D.35x35x35	PZ	10	31,70

Raccordo in Rame a Pressare
Manicotto Tee Femmina





Raccordo in Rame a Pressare
Acqua/Gas Tee Ridotta

CODICE	MISURA	UM	PZ	€
019 042 051	D.15x12x12	PZ	10	17,20
019 042 052	D.15x12x15	PZ	10	8,30
019 042 053	D.15x15x12	PZ	10	13,70
019 042 054	D.18x12x18	PZ	10	12,40
019 042 055	D.18x15x18	PZ	10	8,50
019 042 056	D.22x15x22	PZ	10	11,10
019 042 057	D.22x18x22	PZ	10	13,50
019 042 058	D.28x22x28	PZ	10	22,50
019 042 059	D.35x22x35	PZ	10	25,20
019 042 060	D.35x28x35	PZ	10	30,40



Raccordo in Rame a Pressare
Acqua/Gas Gomito 90°
Maschio Femmina

CODICE	MISURA	UM	PZ	€
019 042 064	D.12x12	PZ	10	4,70
019 042 065	D.15x15	PZ	10	3,70
019 042 066	D.18x18	PZ	10	5,30
019 042 067	D.22x22	PZ	10	6,80
019 042 068	D.28x28	PZ	10	14,90
019 042 069	D.35x35	PZ	10	26,80



Raccordo in Rame a Pressare
Acqua/Gas Gomito 90°
Femmina Femmina

CODICE	MISURA	UM	PZ	€
019 042 073	D.12x12	PZ	10	4,30
019 042 074	D.15x15	PZ	10	4,40
019 042 075	D.18x18	PZ	10	5,70
019 042 076	D.22x22	PZ	10	7,60
019 042 077	D.28x28	PZ	10	13,90
019 042 078	D.35x35	PZ	10	26,40



Raccordo in Rame a Pressare
Acqua/Gas Gomito 45°
Maschio Femmina

CODICE	MISURA	UM	PZ	€
019 042 090	D.12x12	PZ	10	4,00
019 042 091	D.15x15	PZ	10	4,00
019 042 092	D.18x18	PZ	10	4,50
019 042 093	D.22x22	PZ	10	5,90
019 042 094	D.28x28	PZ	10	17,10
019 042 095	D.35x35	PZ	10	24,70



Raccordo in Rame a Pressare
Acqua/Gas Gomito 45°
Femmina Femmina

CODICE	MISURA	UM	PZ	€
019 042 080	D.12x12	PZ	10	5,00
019 042 081	D.15x15	PZ	10	4,70
019 042 082	D.18x18	PZ	10	4,60
019 042 083	D.22x22	PZ	10	6,20
019 042 084	D.28x28	PZ	10	17,80
019 042 085	D.35x35	PZ	10	25,80



CODICE	MISURA	UM	PZ	€
019 042 100	D.12x1/2	PZ	10	9,00
019 042 102	D.15x1/2	PZ	10	5,90
019 042 103	D.15x3/4	PZ	10	10,60
019 042 104	D.18x1/2	PZ	10	6,90
019 042 105	D.18x1/2	PZ	10	11,80
019 042 106	D.22x3/4	PZ	10	9,10
019 042 107	D.22x 1"	PZ	10	13,10
019 042 108	D.28x 1"	PZ	10	15,50
019 042 109	D.35x 1"	PZ	10	35,50

Raccordo in Bronzo Pressare
Acqua/Gas Manicotto Dritto
Femmina



CODICE	MISURA	UM	PZ	€
019 042 110	D.12x1/2	PZ	10	7,30
019 042 112	D.15x1/2	PZ	10	4,20
019 042 113	D.15x3/4	PZ	10	8,40
019 042 114	D.18x1/2	PZ	10	5,90
019 042 115	D.18x3/4	PZ	10	6,90
019 042 116	D.22x3/4	PZ	10	9,40
019 042 117	D.22x 1"	PZ	10	11,60
019 042 118	D.28x 1"	PZ	10	15,00
019 042 119	D.35x 1"	PZ	10	32,40

Raccordo in Bronzo Pressare
Acqua/Gas Manicotto Dritto
Maschio



CODICE	MISURA	UM	PZ	€
019 042 124	D.12x1/2	PZ	10	19,50
019 042 125	D.15x1/2	PZ	10	10,50
019 042 126	D.15x3/4	PZ	10	24,10
019 042 127	D.18x1/2	PZ	10	26,10
019 042 128	D.18x3/4	PZ	10	26,00
019 042 129	D.22x3/4	PZ	10	19,90
019 042 130	D.22x 1"	PZ	10	26,30
019 042 131	D.28x 1"	PZ	10	33,70
019 042 132	D.35x1"x1/4	PZ	10	48,30

Raccordo in Bronzo Pressare
Acqua/Gas Gomito 90°
Femmina



CODICE	MISURA	UM	PZ	€
019 042 140	D.12x1/2	PZ	10	17,20
019 042 141	D.15x1/2	PZ	10	17,00
019 042 142	D.18x1/2	PZ	10	25,50
019 042 143	D.18x3/4	PZ	10	26,20
019 042 144	D.22x3/4	PZ	10	32,80
019 042 145	D.28x 1"	PZ	10	46,90

Raccordo in Bronzo Pressare
Acqua/Gas Gomito 90°
Maschio





Raccordo in Bronzo Pressare
Acqua/Gas Tee
Femmina

CODICE	MISURA	UM	PZ	€
019 042 150	D.12x1/2x12	PZ	10	30,00
019 042 151	D.15x1/2x15	PZ	10	15,70
019 042 152	D.18x1/2x18	PZ	10	31,50
019 042 153	D.22x1/2x22	PZ	10	26,40
019 042 154	D.22x3/4x22	PZ	10	37,00
019 042 155	D.28x1/2x28	PZ	10	26,90
019 042 156	D.28x3/4x28	PZ	10	44,40
019 042 157	D.35x1/2x35	PZ	10	46,20



Raccordo in Bronzo Pressare
Acqua/Gas Adattatore
Maschio

CODICE	MISURA	UM	PZ	€
019 042 170	D.12x1/2	PZ	10	12,40
019 042 171	D.15x1/2	PZ	10	13,10
019 042 172	D.18x1/2	PZ	10	13,60
019 042 173	D.18x3/4	PZ	10	14,40
019 042 174	D.22x1/2	PZ	10	20,80
019 042 175	D.22x3/4	PZ	10	21,70
019 042 176	D.28x 1"	PZ	10	32,10
019 042 177	D.35x 1"x1/4	PZ	10	42,30



Raccordo in Bronzo Pressare
Acqua/Gas Gomito Flangiato
Femmina

CODICE	MISURA	UM	PZ	€
019 042 180	D.12x1/2	PZ	10	17,90
019 042 181	D.15x1/2	PZ	10	11,40
019 042 182	D.18x1/2	PZ	10	18,60
019 042 183	D.22x3/4	PZ	10	30,70



Pressatrice Elettrica
con Valigietta

CODICE	MISURA	UM	PZ	€
019 042 200	Kit Pressatrice Elettrica	PZ	1	2836,40
019 042 201	Kit Pressatrice Batteria	PZ	1	3264,30



Ganasce a Pressare

CODICE	MISURA	UM	PZ	€
019 042 202	D.12	PZ	1	372,50
019 042 203	D.15	PZ	1	372,50
019 042 204	D.18	PZ	1	372,50
019 042 205	D.22	PZ	1	372,50
019 042 206	D.28	PZ	1	372,50
019 042 207	D.35	PZ	1	372,50



CODICE	MISURA	UM	PZ	€
019 023 015	TE406 Installazione Parete	PZ	1	141,70

Termostato Ambiente
T-Touch a Parete



CODICE	MISURA	UM	PZ	€
019 023 016	TE401 Installazione da Incasso	PZ	1	138,80

Termostato Ambiente
T-Touch da Incasso



CODICE	MISURA	UM	PZ	€
019 043 005	CR160 Installazione Parete	PZ	1	221,20

Cronotermostato Ambiente
T-Touch a Parete



CODICE	MISURA	UM	PZ	€
019 043 006	CR150 Installazione da Incasso	PZ	1	221,20

Cronotermostato Ambiente
T-Touch da incasso



CODICE	MISURA	UM	PZ	€
019 023 004	con Spia	PZ	1	28,40

Termostato Ambiente
Meccanico



CODICE	MISURA	UM	PZ	€
019 023 003	con Spia e Interruttore On-Off	PZ	1	33,30

Termostato Ambiente
Meccanico



CODICE	MISURA	UM	PZ	€
019 043 001	Giornaliero Settimanale	PZ	1	94,90

Cronotermostato Ambiente
Meccanico a Parete



CODICE	MISURA	UM	PZ	€
019 043 004	Giornaliero	PZ	1	79,10

Cronotermostato Ambiente
Digitale Giornaliero con
Cavaliere Life



CODICE	MISURA	UM	PZ	€
019 043 002	Giornaliero Settimanale	PZ	1	140,40

Cronotermostato Ambiente
Digitale a Parete





Centralina Digitale
per Termocamino

CODICE	MISURA	UM	PZ	€
019 023 012	Con tre Uscite Termocamino Elettrovalvola Circolatore e Gestrione Girarosto	PZ	1	101,60



Centralina Meccanica
per Termocamino

CODICE	MISURA	UM	PZ	€
019 023 002	Con Interruttore Girarosto e Regolazione di Temperatura	PZ	1	101,60



Modulo Separazione
di Circuito Termico
Caldaia e Termocamino

CODICE	MISURA	UM	PZ	€
022 045 013	Separazione di Circuito Termocamino e Caldaia Gas	PZ	1	1170,10



Modulo di Gestione
Produzione Acqua Sanitaria
Camino Stufa Pellet

CODICE	MISURA	UM	PZ	€
022 045 010	Kw 14 Interfaccia Camino Stufa Pellet	PZ	1	1137,60



Modulo di Gestione
Produzione Acqua Sanitaria
Camino Caldaia

CODICE	MISURA	UM	PZ	€
022 045 011	Kw 30 Interfaccia Caldaia Termocamino	PZ	1	1706,30



Pozzetto Portasonda
Termometro

CODICE	MISURA	UM	PZ	€
019 091 031	Portasonda Termometro	PZ	1	11,40



Scambiatore a Piastre
per uso Sanitario

CODICE	MISURA	UM	PZ	€
022 045 015	14 Piastre D.3/4x1/2 Zilmet	pz	1	147,90
022 045 016	20 Piastre D.3/4x1/2 Zilmet	PZ	1	158,50
022 045 017	30 Piastre D.3/4x3/4 Zilmet	PZ	1	195,10
022 045 018	40 Piastre D.3/4x3/4 Zilmet	PZ	1	280,40

SETTORE 019
RISCALDAMENTO



CODICE	MISURA	UM	PZ	€
019 017 030	Normalmente Chiusa D.1/2 230V	PZ	1	71,00
019 017 034	Normalmente Chiusa D.3/4 230V	PZ	1	93,60
019 017 038	Normalmente Chiusa D.1" 230V	PZ	1	111,20

Elettrovalvola a Membrana per Acqua



CODICE	MISURA	UM	PZ	€
019 017 031	Normalmente Aperta D.1/2 230V	PZ	1	113,10
019 017 033	Normalmente Aperta D.3/4 230V	PZ	1	115,50
019 017 039	Normalmente Aperta D.1" 230V	PZ	1	125,90

Elettrovalvola a Membrana per Acqua



CODICE	MISURA	UM	PZ	€
019 017 029	12V A.C.	PZ	1	28,80
019 017 028	24V A.C.	PZ	1	28,80

Bobina per Elettrovalvole



CODICE	MISURA	UM	PZ	€
019 017 036	Normalmente Chiusa D.1" 230V	PZ	1	117,70
019 017 037	Normalmente Aperta D.1" 230V	PZ	1	90,20

Elettrovalvola a Membrana per Gas



CODICE	MISURA	UM	PZ	€
019 091 023	D.3/4X2 VIE FEMMINA 230V	PZ	1	175,40
019 091 020	D.1" X2 VIE FEMMINA 230V	PZ	1	175,40

Valvola di Zona Motorizzata 2 Vie



CODICE	MISURA	UM	PZ	€
019 091 024	D.3/4X3 VIE FEMMINA 230V	PZ	1	182,70
019 091 021	D.1" X3 VIE FEMMINA 230V	PZ	1	190,90

Valvola di Zona Motorizzata 3 Vie



CODICE	MISURA	UM	PZ	€
019 091 026	D.1" X4 VIE FEMMINA 230V	PZ	1	206,60

Valvola di Zona Motorizzata 4 Vie



CODICE	MISURA	UM	PZ	€
019 092 001	D.3/4X2 VIE FEMMINA a Sfera 230V	PZ	1	187,10
019 092 002	D.1" X2 VIE FEMMINA a Sfera 230V	PZ	1	200,10

Valvola di Zona Motorizzata 2 Vie a Sfera



CODICE	MISURA	UM	PZ	€
019 092 010	D.3/4X3 VIE FEMMINA a Sfera 230V	PZ	1	208,30
019 092 011	D.1" X3 VIE FEMMINA a Sfera 230V	PZ	1	226,50

Valvola di Zona Motorizzata 3 Vie a Sfera



CODICE	MISURA	UM	PZ	€
019 092 030	D.1" X4 VIE FEMMINA a Sfera 230V	PZ	1	325,20

Valvola di Zona Motorizzata 4 Vie a Sfera





Flussostato Pressostato
Segnalazione di Flusso

CODICE	MISURA	UM	PZ	€
019 091 030	D.1/2 M.M.	PZ	1	128,00



Termostato a Contatto
Bracciale

CODICE	MISURA	UM	PZ	€
019 130 001	da 0° a +120°	PZ	1	33,90



Valvola di Sicurezza Termica

CODICE	MISURA	UM	PZ	€
019 091 035	D.3/4x1/2	PZ	1	202,70



Gruppo di Sicurezza Safe
Circuito Chiuso

CODICE	MISURA	UM	PZ	€
019 130 006	D.1" Maschio Femmina	PZ	1	102,20



Gruppo d Riempimento
per Caldaia
Senza Manometro

CODICE	MISURA	UM	PZ	€
019 130 002	D.1/2 Maschio Femmina	PZ	1	52,10



Valvola Anticondensa

CODICE	MISURA	UM	PZ	€
019 091 038	D.1" 50°	PZ	1	166,60
019 091 039	D.1" 55°	PZ	1	166,60



Separatore D'Aria
per Impianti di Riscaldamento

CODICE	MISURA	UM	PZ	€
019 053 002	D.1"1/2	PZ	1	82,50



CODICE	MISURA	UM	PZ	€
019 091 017	D.3/8	PZ	1	2,50
019 091 018	D.1/2	PZ	1	3,50

Rubinetto Intercettazione
Valvola Sfiato Automatico



CODICE	MISURA	UM	PZ	€
019 091 006	D.3/8 Valmat Baby	PZ	10	8,50
019 091 008	D.1/2 Valmat Baby	pz	10	8,60

Valvola di Sfiato Aria
Automatica Diritta
Valmat Baby



CODICE	MISURA	UM	PZ	€
019 091 007	D.3/8 Ottone Giallo	pz	10	8,50

Valvola di Sfiato Aria
Automatica Laterale
Ottone Giallo



CODICE	MISURA	UM	PZ	€
019 091 014	D.3/8 Ottone Cromato	PZ	10	7,90
019 091 015	D.1/2 Ottone Cromato	PZ	10	8,00

Valvola di Sfiato Aria
Automatica Laterale
Ottone Cromato



CODICE	MISURA	UM	PZ	€
019 091 011	D.1" Destra	PZ	10	7,70

Valvola di Sfiato Aria
Destra Automatica
Ottone Cromato



CODICE	MISURA	UM	PZ	€
019 091 012	D.1" Sinistra	PZ	10	7,70

Valvola di Sfiato Aria
Sinistra Automatica
Ottone Cromato



CODICE	MISURA	UM	PZ	€
019 099 071	D.1/4 Nichelato	PZ	10	3,80
019 099 068	D.1/4 Nichelato	PZ	10	2,00
019 099 029	D.3/8 Nichelato	PZ	10	1,50
019 099 072	D.3/8 Nichelato	PZ	10	4,60

Valvolino di Sfiato Manuale
Nichelato



CODICE	MISURA	UM	PZ	€
019 141 031	D.1/2 M.F. 1,5 Atm	PZ	10	15,60
019 141 014	D.1/2 M.F. 3 Atm	PZ	10	15,40
019 141 028	D.1/2 M.F. 6 Atm	PZ	10	15,80
019 141 015	D.1/2 M.F. 8 Atm	PZ	10	23,30
019 141 023	D.3/4 M.F. 3 Atm	PZ	10	19,20
019 141 029	D.3/4 M.F. 8 Atm	PZ	10	33,20

Valvola di Sicurezza
Maschio Femmina





Esalatore
per Scaldino o Caldaia

CODICE	MISURA	UM	PZ	€
019 038 013	D.110x45 Bianco	PZ	1	20,60
019 038 012	D.120x45 Bianco	PZ	1	20,60
019 038 008	D.130x45 Bianco	PZ	1	20,60
019 038 010	D.135x45 Bianco	PZ	1	20,00
019 038 004	D.140x45 Bianco	PZ	1	20,60
019 038 018	D.150x45 Bianco	PZ	1	20,00



Esalatore per Caldaia
Applicazione Vetro

CODICE	MISURA	UM	PZ	€
019 038 001	D.130 Bianco	PZ	1	31,30
019 038 002	D.135 Bianco	PZ	1	31,30
019 038 003	D.140 Bianco	PZ	1	31,30



Armadietto
per Scaldino o Caldaia
Bianco

CODICE	MISURA	UM	PZ	€
019 038 005	H102xL55xP45xCaldaia	PZ	1	73,20
019 038 006	H 92xL55xP35xCaldaia	PZ	1	67,70
019 038 011	H 87xL48xP35xScaldino	PZ	1	70,90
019 143 010	Chiave Armadietti e Sportelli Acqua Gas Plastica Tavellino	PZ	1	1,10



Vaso Espansione in Plastica
Completo di Raccordi

CODICE	MISURA	UM	PZ	€
019 038 014	Lt 30 Vaso Espansione	PZ	1	34,30



Vaso Espansione Zincato
Senza Raccordi

CODICE	MISURA	UM	PZ	€
019 038 007	Lt 30 Cm 26x48x25	PZ	1	44,50
019 038 020	2 Prolunghe 1" + 2 ghiera 1" + 1 prolunga 3/8)	PZ	1	13,70



Vaso Espansione Acciaio
con Raccordi

CODICE	MISURA	UM	PZ	€
019 038 016	Lt 30 Cm 26x48x25	PZ	1	84,90



CODICE	MISURA	UM	PZ	€
019 143 003	Sportello Zincato per Contatore Gas Cm 45x35 - Con Chiave	PZ	1	18,70

Sportello Zincato
per Contatore Gas



CODICE	MISURA	UM	PZ	€
019 143 004	Cm 45x35x25 - Con Chiave	PZ	1	34,20

Armadietto Zincato
per Contatore Gas



CODICE	MISURA	UM	PZ	€
019 143 007	Cm 30x40 con Chiave	PZ	1	26,80

Armadietto Zincato
per Contatore Acqua



CODICE	MISURA	UM	PZ	€
019 143 005	Cm 30x40 - Con Chiave	PZ	1	16,20

Sportelle Zincato
per Contatore Acqua



CODICE	MISURA	UM	PZ	€
019 142 005	mm 300x250x900	PZ	1	18,50
019 142 007	mm 480x250x950	PZ	1	24,80
019 142 019	mm 600x300x950	PZ	1	27,00
019 142 008	Supporti Regolabili per Collettori	PZ	1	3,30

Cassetta per Collettori
in Plastica



CODICE	MISURA	UM	PZ	€
019 141 016	mm 400x300x250	PZ	1	12,00
019 141 041	mm 480x300x250	PZ	1	13,50
019 141 017	mm 600x300x700	PZ	1	26,50

Cassetta in Lamiera
per Collettori





Tappo Destro
Cieco Verniciato

CODICE	MISURA	UM	PZ	€
019 099 001	D.1" Esterno D.42 per Radiat.Allum.	PZ	10	1,70
019 099 009	D.1" Esterno D.48 per Radiat.Ghisa	PZ	10	1,40
019 099 064	D.1"1/4 Esterno D.56 per Radiat.Ghisa	PZ	10	3,10



Tappo Sinistro
Cieco Verniciato

CODICE	MISURA	UM	PZ	€
019 099 002	D.1" Esterno D.42 per Radiat.Allum.	PZ	10	1,90
019 099 010	D.1" Esterno D.48 per Radiat.Ghisa	PZ	10	1,30
019 099 065	D.1"1/4 Esterno D.56 per Radiat.Ghisa	PZ	10	3,10



Tappo Destro
Cieco Zincato

CODICE	MISURA	UM	PZ	€
019 099 056	D.1" Esterno D.42 per Radiat.Allum.	PZ	10	0,80
019 099 005	D.1" Esterno D.48 per Radiat.Ghisa	PZ	10	1,30
019 099 060	D.1"1/4 Esterno D.56 per Radiat.Ghisa	PZ	10	1,90



Tappo Sinistro
Cieco Zincato

CODICE	MISURA	UM	PZ	€
019 099 057	D.1" Esterno D.42 per Radiat.Allum.	PZ	10	0,80
019 099 006	D.1" Esterno D.48 per Radiat.Ghisa	PZ	10	1,40
019 099 061	D.1"1/4 Esterno D.56 per Radiat.Ghisa	PZ	10	1,60



Riduzione Destra
Verniciata

CODICE	MISURA	UM	PZ	€
019 099 003	D.1"x3/8 Esterno D.42 per Allum.	PZ	10	1,10
019 099 017	D.1"x1/2 Esterno D.42 per Allum.	PZ	10	1,20
019 099 026	D.1"x3/4 Esterno D.42 per Allum.	PZ	10	1,70
019 099 011	D.1"x3/8 Esterno D.48 per Ghisa	PZ	10	1,40
019 099 018	D.1"x1/2 Esterno D.48 per Ghisa	PZ	10	1,30
019 099 015	D.1"x3/4 Esterno D.48 per Ghisa	PZ	10	2,00
019 099 066	D.1"1/4x3/8 Esterno D.56 per Ghisa	PZ	10	3,30



Riduzione Sinistra
Verniciata

CODICE	MISURA	UM	PZ	€
019 099 004	D.1"x3/8 Esterno D.42 per Allum.	PZ	10	1,20
019 099 019	D.1"x1/2 Esterno D.42 per Allum.	PZ	10	1,50
019 099 027	D.1"x3/4 Esterno D.42 per Allum.	PZ	10	1,70
019 099 012	D.1"x3/8 Esterno D.48 per Ghisa	PZ	10	1,40
019 099 020	D.1"x1/2 Esterno D.48 per Ghisa	PZ	10	1,30
019 099 016	D.1"x3/4 Esterno D.48 per Ghisa	PZ	10	1,80
019 099 067	D.1"1/4x3/8 Esterno D.56 per Ghisa	PZ	10	3,30



Riduzione Destra Zincata

CODICE	MISURA	UM	PZ	€
019 099 058	D.1"x1/2 Esterno D.42 per Allum.	PZ	10	1,00
019 099 021	D.1"x3/4 Esterno D.42 per Allum.	PZ	10	1,00
019 099 007	D.1"x3/8 Esterno D.48 per Ghisa	PZ	10	1,50
019 099 054	D.1"x1/2 Esterno D.48 per Ghisa	PZ	10	1,30
019 099 013	D.1"x3/4 Esterno D.48 per Ghisa	PZ	10	1,30
019 099 062	D.1"1/4x3/8 Esterno D.56 per Ghisa	PZ	10	1,90



Riduzione Sinistra Zincata

CODICE	MISURA	UM	PZ	€
019 099 059	D.1"x3/8 Esterno D.42 per Allum.	PZ	10	1,20
019 099 022	D.1"x1/2 Esterno D.42 per Allum.	PZ	10	1,00
019 099 008	D.1"x3/8 Esterno D.48 per Ghisa	PZ	10	1,60
019 099 055	D.1" x1/2 Esterno D.48 per Ghisa	PZ	10	0,90
019 099 014	D.1"x3/4 Esterno D.48 per Ghisa	PZ	10	1,20
019 099 063	D.1"1/4x3/8 Esterno D.56 per Ghisa	PZ	10	2,00
019 099 069	D.1"1/4x1" Esterno D.56 per Ghisa	PZ	10	2,00



CODICE	MISURA	UM	PZ	€
019 099 030	D.1"X3/8	PZ	20	6,80
019 099 031	D.1"X1/2	PZ	20	8,50

Kit Tappi Riduzioni Valvolino Bianco per Radiatori



CODICE	MISURA	UM	PZ	€
019 099 032	D.1"X3/8 Completa Mensola	PZ	20	11,30
019 099 033	D.1"X1/2 Completa Mensola	PZ	20	12,50

Kit Tappi Riduzioni Valvolino con Mensole Bianco per Radiatori



CODICE	MISURA	UM	PZ	€
019 099 080	D.1/2		10	1,00

Tappo in Ottone Cromato Capuccio Bianco con Tenuta O-Ring



CODICE	MISURA	UM	PZ	€
019 099 070	D.1/4-1"-1"1/4	PZ	1	9,30

Chiave Radiatori in Nylon per Tappi e Riduzioni



CODICE	MISURA	UM	PZ	€
001 099 074	D.1"	PZ	10	0,90
001 099 075	D.1"1/4	PZ	10	0,90

Doppia Vite per Aggiunzione radiatori



CODICE	MISURA	UM	PZ	€
019 001 067	D.10-22	PZ	10	0,20

Rosetta Copritubo Bianca Normale



CODICE	MISURA	UM	PZ	€
019 001 070	D.10-22	PZ	10	0,80

Rosetta Copritubo Cromata Normale



CODICE	MISURA	UM	PZ	€
019 001 069	D.10-22	PZ	10	0,70

Rosetta Copritubo Bianca Sombrero



CODICE	MISURA	UM	PZ	€
019 001 068	D.10-18	PZ	10	0,40

Rosetta Copritubo Bianca Prolungata





Kit Valvola Detentore
a Squadro Completo
di Adattatori Multistrato

CODICE	MISURA	UM	PZ	€
019 141 038	D.3/8x16	PZ	10	19,50
019 142 001	D.1/2x16	PZ	10	19,60



Kit Valvola Detentore
a Squadro Completo
di Adattatori Rame

CODICE	MISURA	UM	PZ	€
019 141 030	D.3/8x12	PZ	10	15,90
019 142 040	D.1/2x12	PZ	10	16,90



Kit Valvola Detentore
Diritto Completo
di Adattatori Multistrato

CODICE	MISURA	UM	PZ	€
019 142 026	D.1/2x16	PZ	10	21,30



Kit Valvola Detentore
Diritto Completo
di Adattatori Rame

CODICE	MISURA	UM	PZ	€
019 142 041	D.1/2x12	PZ	10	21,50



Valvola Diritta Completo
di Adattatori Multistrato

CODICE	MISURA	UM	PZ	€
019 141 051	D.1/2x1/2x16-295	PZ	10	8,00



Detentore Diritta
Completo di Adattatore
Multistrato

CODICE	MISURA	UM	PZ	€
019 141 053	D.1/2x1/2x16-297	PZ	10	7,30



Valvola Squadro Singola

CODICE	MISURA	UM	PZ	€
019 141 034	D.3/8x1/2 Itap 395	PZ	10	7,20
019 141 037	D.1/2x1/2 Itap 395	PZ	10	7,60



Dedentore Squadro Singolo

CODICE	MISURA	UM	PZ	€
019 141 035	D.3/8x1/2 Itap 397	PZ	10	6,50
019 141 036	D.1/2x1/2 Itap 397	PZ	10	6,90



CODICE	MISURA	UM	PZ	€
019 141 019	D.3/4 Destra	PZ	10	36,30
019 141 012	D.1" Destra	PZ	10	40,00
019 141 020	D.1" Sinistra	PZ	10	40,00

Valvola Monotubo Cromata
Semplice Regolazione



CODICE	MISURA	UM	PZ	€
001 002 373	D.14x1/2x2,00	PZ	10	2,80
001 167 012	D.16x1/2x2,00	PZ	10	2,70
001 002 376	D.16x1/2x2,25	PZ	10	3,00
001 002 374	D.16x3/4x2,25	PZ	10	3,60
001 002 378	D.20x3/4x2,00	PZ	10	4,00
001 002 379	D.20x3/4x2,25	PZ	10	4,20

Adattatore
per Tubo Multistrato



CODICE	MISURA	UM	PZ	€
019 142 021	D.1/2x12	PZ	10	2,70
019 142 022	D.1/2x14	PZ	10	2,90
019 142 023	D.1/2x16	PZ	10	2,90

Adattatore Sicurblok
per Tubo Rame



CODICE	MISURA	UM	PZ	€
019 017 095	D.1/2x12	PZ	10	2,10
019 017 096	D.1/2x14	PZ	10	2,10

Dado Ottone Giallo + Ogiva
Monocono in Teflon
per Collettori



CODICE	MISURA	UM	PZ	€
019 141 009	D.1/2x12x24	PZ	10	2,40
019 141 013	D.1/2x14x24	PZ	10	2,40
019 141 024	D.1/2x16x24	PZ	10	2,40
019 141 025	D.1/2x18x24	PZ	10	2,40

Adattatore Dado Monocono
Valvola Monotubo
per Tubo Rame





Valvola Squadro
Manuale Far

CODICE	MISURA	UM	PZ	€
019 144 004	D.3/8x24x19	PZ	10	12,80
019 144 130	D.1/2x24x19	PZ	10	14,30



Detentore Squadro
Manuale Far

CODICE	MISURA	UM	PZ	€
019 144 019	D.3/8x24x19	PZ	10	10,70
019 144 131	D.1/2x24x19	PZ	10	12,80



Valvola Diritta
Manuale Far

CODICE	MISURA	UM	PZ	€
019 144 017	D.3/8x24x19	PZ	10	13,90
019 144 139	D.1/2x24x19	PZ	10	22,10



Detentore Diritto
Manuale Far

CODICE	MISURA	UM	PZ	€
019 144 018	D.3/8x24x19	PZ	10	11,40
019 144 140	D.1/2x24x19	PZ	10	14,30



Adattatore
Kit per Tubo Rame Far

CODICE	MISURA	UM	PZ	€
019 144 036	D.10x24x19	PZ	10	3,00
019 144 037	D.12x24x19	PZ	10	3,10
019 144 038	D.14x24x19	PZ	10	3,00
019 144 039	D.16x24x19	PZ	10	2,90



Adattatore
Kit per Tubo Reticolene Far

CODICE	MISURA	UM	PZ	€
019 144 050	D.15x24x19	PZ	10	5,10
019 144 051	D.18x24x19	PZ	10	5,10



Adattatore
Kit per Tubo Multistrato Far

CODICE	MISURA	UM	PZ	€
019 144 041	D.14x2 x24x19	PZ	10	5,50
019 144 042	D.16x2 x24x19	PZ	10	5,10
019 144 043	D.16x2,25x24x19	PZ	10	5,10
019 144 044	D.20x2 x24x19	PZ	10	5,10
019 144 045	D.20x2,25x24x19	PZ	10	5,80
019 144 046	D.20x2,50x24x19	PZ	10	5,80



CODICE	MISURA	UM	PZ	€
019 144 010	D.3/4x24x19 MF	PZ	10	34,70
019 144 011	D.1" x24x19 MF	PZ	10	38,10

Collettore Far 2 Vie
con Rubinetto Blu/Rosso Far



CODICE	MISURA	UM	PZ	€
019 144 012	D.3/4x24x19 MF	PZ	10	47,90
019 144 013	D.1" x24x19 MF	PZ	10	50,90

Collettore Far 3 Vie
con Rubinetto Blu/Rosso Far



CODICE	MISURA	UM	PZ	€
019 144 014	D.3/4x24x19 MF	PZ	10	62,80
019 144 015	D.1" x24x19 MF	PZ	10	70,60

Collettore Far 4 Vie
con Rubinetto Blu/Rosso Far



CODICE	MISURA	UM	PZ	€
019 144 026	D.3/4x24x19 MF	PZ	10	14,30
019 144 027	D.1" x24x19 MF	PZ	10	16,80

Collettore Far 2 Vie
Cromato Normale Far



CODICE	MISURA	UM	PZ	€
019 144 028	D.3/4x24x19 MF	PZ	10	19,90
019 144 029	D.1" x24x19 MF	PZ	10	22,60

Collettore Far 3 Vie
Cromato Normale Far



CODICE	MISURA	UM	PZ	€
019 144 030	D.3/4x24x19 MF	PZ	10	23,50
019 144 031	D.1" x24x19 MF	PZ	10	28,10

Collettore Far 4 Vie
Cromato Normale Far



CODICE	MISURA	UM	PZ	€
019 144 020	D.3/4x24x19 MF	PZ	10	12,90
019 144 021	D.1" x24x19 MF	PZ	10	15,00

Collettore Far 2 Vie
Cromato Cieco





Valvola a Squadro
Termostatica Far

CODICE	MISURA	UM	PZ	€
019 144 135	D.3/8x24x19	PZ	1	18,50
019 144 136	D.1/2x24x19	PZ	1	21,50



Detentore a Squadro
Far

CODICE	MISURA	UM	PZ	€
019 144 019	D.3/8x24x19	PZ	1	10,70
019 144 131	D.1/2x24x19	PZ	1	12,80



Valvola Diritta
Termostatica Far

CODICE	MISURA	UM	PZ	€
019 144 138	D.3/8x24x19	PZ	1	20,20
019 144 139	D.1/2x24x19	PZ	1	22,10



Detentore Diritto
Far

CODICE	MISURA	UM	PZ	€
019 144 018	D.3/8x24x19	PZ	1	11,40
019 144 140	D.1/2x24x19	PZ	1	14,30



Testina con Sensore Liquido
Far

CODICE	MISURA	UM	PZ	€
019 144 009	Far 1824	PZ	1	29,00



Valvola Automatica Sicurezza
Impianti Circuiti Chiusi Far

CODICE	MISURA	UM	PZ	€
019 144 102	D.1/2x1/2 MF Bar3	PZ	1	18,50
019 144 103	D.1/2x1/2 MF Bar3	PZ	1	18,90



Gruppo Riempimento Far
Maschio Femmina

CODICE	MISURA	UM	PZ	€
019 144 106	D.1/2 Maschio Femmina	PZ	1	62,10



Separatore Aria Far
per Impiati Termici

CODICE	MISURA	UM	PZ	€
019 144 108	D.1"	PZ	1	40,10



CODICE	MISURA	UM	PZ	€
019 144 110	D.1/2	PZ	1	140,70
019 144 111	D.3/4	PZ	1	172,10
019 144 112	D.1"	PZ	1	247,30

Riduttore Pressione Far M.F.
con Bocchettoni 25 Bar



CODICE	MISURA	UM	PZ	€
019 144 115	D.1/2	PZ	1	41,20

Ammortizzatore Anti Colpo
D'ariete Far



CODICE	MISURA	UM	PZ	€
019 144 120	D.1/2 Apertura 20 Secondi a Sblocco Manuale	PZ	1	272,60
019 144 121	D.3/4 Apertura 20 Secondi a Sblocco Manuale	PZ	1	285,50
019 144 122	D.1" Apertura 20 Secondi a Sblocco Manuale	PZ	1	316,60

Valvola di Zona Motorizzata
Far 2 Vie a Sfera M.M.
Con Bocchettoni



CODICE	MISURA	UM	PZ	€
019 144 125	D.1/2 Apertura 20 Secondi a Sblocco Manuale	PZ	1	285,90
019 144 126	D.3/4 Apertura 20 Secondi a Sblocco Manuale	PZ	1	299,70
019 144 127	D.1" Apertura 20 Secondi a Sblocco Manuale	PZ	1	334,80

Valvola di Zona Motorizzata
Far 3 Vie a Sfera
Maschio Maschio
Con Bocchettoni



CODICE	MISURA	UM	PZ	€
019 144 116	D.3/4 FF FAR 2275 34		1	146,10

Defangatore Far Ultracompatto
Bianco Con Magnete
per Impianti Termici



CODICE	MISURA	UM	PZ	€
019 144 117	D.1" non Magnetico	PZ	1	119,30

Defangatore per Impianti
Termici Far



CODICE	MISURA	UM	PZ	€
019 144 118	D.1" non Magnetico	PZ	1	165,20

Disaeratore per Impianti
Termici Far



CODICE	MISURA	UM	PZ	€
019 146 150	D.3/4 TE-SA 60MT-05 DA 3-4"	PZ	1	168,60
019 146 151	D. 1" TE-SA 60MT-06 DA 1"	PZ	1	210,50

Defangatore Te-Sa
con Filtro e Magnete
per Impianti Termici



CODICE	MISURA	UM	PZ	€
019 091 033	D.3/4 Femmina	PZ	1	105,70

Defangatore Mut
DF Super Compact
con Magnete





Cassetta per Collettori Far
"Tutto" in Plastica

CODICE	MISURA	UM	PZ	€
019 144 060	Cm30x25x8	PZ	1	33,40
019 144 061	Cm40x25x8	PZ	1	37,40
019 144 062	Cm48x25x8	PZ	1	44,60
019 144 063	Cm60x30x8	PZ	1	57,40
019 144 064	Cm50x35x10	PZ	1	75,70



Supporti Collettori Cassetta
Far in Plastica

CODICE	MISURA	UM	PZ	€
019 144 068	D.3/4	PZ	10	4,80
019 144 069	D.1"	PZ	10	4,70



Tappo Cieco Far
Kit di Chiusura

CODICE	MISURA	UM	PZ	€
019 144 071	D.24x19	PZ	10	3,40



Tappo Cieco Far
Con Guarnizione

CODICE	MISURA	UM	PZ	€
019 144 072	D.3/4	PZ	10	3,60
019 144 073	D.1"	PZ	10	4,70



Raccordo Terminale
a Squadro Far

CODICE	MISURA	UM	PZ	€
019 144 080	D.3/4x3/8	PZ	10	7,00
019 144 081	D.3/4x1/2	PZ	10	7,60
019 144 082	D.1" x3/8	PZ	10	9,50
019 144 083	D.1" x1/2	PZ	10	8,50



Riduzione Maschio Femmina
con Guarnizione Far

CODICE	MISURA	UM	PZ	€
019 144 086	D.3/4x3/8	PZ	10	4,10
019 144 093	D.3/4x1/2	PZ	10	4,50
019 144 094	D.1" x3/8	PZ	10	4,80
019 144 095	D.1" x1/2	PZ	10	5,10



Tappo Femmina
Con Guarnizione Far

CODICE	MISURA	UM	PZ	€
019 144 092	D.3/4x3/8	PZ	10	4,60
019 144 087	D.3/4x1/2	PZ	10	4,60
019 144 088	D.1" x3/8	PZ	10	5,70
019 144 089	D.1" x1/2	PZ	10	5,90



Tappo Maschio Terminale
con O-Ring Far

CODICE	MISURA	UM	PZ	€
019 144 076	D. 3/4	PZ	10	4,20
019 144 077	D.1"	PZ	10	4,60



Chiave Poligonale
per Calotta Far

CODICE	MISURA	UM	PZ	€
019 144 098	D.27	PZ	1	24,40



Astuccio Chiave
e Cricchetto Far

CODICE	MISURA	UM	PZ	€
019 144 099	D.27-3/8-1/2-3/4	PZ	1	91,80



CODICE	MISURA	UM	PZ	€
019 146 001	D.3/8x1/2 Art.104/1-03	PZ	10	10,90
019 146 006	D.1/2x1/2 Art.104/1-04	PZ	10	12,80
019 146 003	D.1/2x3/4 Art.104/1-045	PZ	10	13,60

Valvola Squadro Manuale
Cromata con Manopola
Te-Sa



CODICE	MISURA	UM	PZ	€
019 146 002	D.3/8x1/2 Art.105/1-03	PZ	10	9,50
019 146 007	D.1/2x1/2 Art.105/1-04	PZ	10	11,20
019 146 004	D.1/2x3/4 Art.105/1-045	PZ	10	12,70

Detentore Squadro Manuale
Cromato con Manopola
Te-Sa



CODICE	MISURA	UM	PZ	€
019 146 010	D.3/8x1/2 Art.106/1-03	PZ	10	11,80
019 146 011	D.1/2x1/2 Art.106/1-04	PZ	10	13,00
019 146 013	D.1/2x3/4 Art.106/1-045	PZ	10	12,20

Valvola Diritta Manuale
Cromata con Manopola
Te-Sa



CODICE	MISURA	UM	PZ	€
019 146 017	D.3/8x1/2 Art.107/1-03	PZ	10	10,30
019 146 018	D.1/2x1/2 Art.107/1-04	PZ	10	11,30
019 146 019	D.1/2x3/4 Art.107/1-045	PZ	10	11,00

Detentore Diritto Manuale
Cromato con Manopola
Te-Sa



CODICE	MISURA	UM	PZ	€
019 146 025	D.3/8x1/2 Art.114T/1-03	PZ	10	12,10
019 146 026	D.1/2x1/2 Art.114T/1-04	PZ	10	15,30
019 146 027	D.1/2x3/4 Art.114T/1-045	PZ	10	14,30

Valvola Squadro Termostabile
Cromata con Manopola
Te-Sa



CODICE	MISURA	UM	PZ	€
019 146 030	D.30x1,5 Bianca Art.116	PZ	1	17,60
019 146 031	D.30x1,5 Cromata Art.116HT	PZ	1	26,30

Testa Termostatica
con Sensore Liquido Te-Sa



CODICE	MISURA	UM	PZ	€
019 146 015	D.3/8x1/2 Art.115T/1-03	PZ	10	14,50
019 146 016	D.1/2x1/2 Art.115T/1-04	PZ	10	15,50
019 146 014	D.1/2x3/4 Art.115/1-045	PZ	10	15,10

Valvola Diritta Termostabile
Cromata con Manopola
Te-Sa





Valvola Squadro Manuale
con Manopola
Te-Sa

* Singolo prodotto

CODICE	MISURA	UM	PZ	€
019 146 035	D.1/2x1/2 Art.104HM-04 Cromata	PZ	10	25,80
019 146 050	D.1/2x1/2 Art.104HM-04B Bianca	PZ	10	25,30



Detentore Squadro Manuale
Lucido Te-Sa

* Singolo prodotto

CODICE	MISURA	UM	PZ	€
019 146 036	D.1/2x1/2 Art.105HM-04	PZ	10	21,10
019 146 051	D.1/2x1/2 Art.105HM-04B	PZ	10	21,00



Valvola Diritta Manuale
con Manopola
Te-Sa

* Singolo prodotto

CODICE	MISURA	UM	PZ	€
019 146 040	D.1/2x1/2 Art.106HM-04 Cromata	PZ	10	26,90
019 146 055	D.1/2x1/2 Art.106HM-04B Bianca	PZ	10	28,50



Detentore Dritto
Manuale Te-Sa

CODICE	MISURA	UM	PZ	€
019 146 041	D.1/2x1/2 Art.107HM-04 Cromato	PZ	10	22,00



Kit Valvola e Detentore
Squadro Termostabilizzabile
Te-Sa

CODICE	MISURA	UM	PZ	€
019 146 053	D.1/2x1/2 Art.114KHT-04 Cromato	PZ	10	49,50
019 146 052	D.1/2x1/2 Art.114KHT-04B Bianco	PZ	10	73,70



Kit Valvola e Detentore
Diritto Termostabilizzabile
Te-Sa

CODICE	MISURA	UM	PZ	€
019 146 058	D.1/2x1/2 Art.115KHP-04 Cromato	PZ	10	69,20
019 146 057	D.1/2x1/2 Art.115KHP-04B Bianco	PZ	10	69,20



Calotta e Codolo
Adattatore
con Guarnizione
Te-Sa

CODICE	MISURA	UM	PZ	€
019 146 059	D. 3/4 F x 3/8 M Cromato 286HT053	PZ	10	12,30



CODICE	MISURA	UM	PZ	€
019 146 056	D.1/2x1/2 Art.107HM-04B	PZ	10	24,80

Detentore Diritto Manuale
Bianca Te-Sa



CODICE	MISURA	UM	PZ	€
019 146 110	D.1/2x1/2 Dx Art.114SHT-04-DX	PZ	10	65,20
019 146 111	D.1/2x1/2 Sx Art.114SHT-04-SX	PZ	10	77,80

Valvola Angolo Doppio
Termostattizzabile Te-Sa
Lucida con Manopola



CODICE	MISURA	UM	PZ	€
019 146 115	D.1/2x1/2 Dx Art.105SHM-045	PZ	10	62,20
019 146 116	D.1/2x1/2 Sx Art.105SHM-045	PZ	10	70,60

Detentore Angolo Doppio
Termostattizzabile Te-Sa
Lucido



CODICE	MISURA	UM	PZ	€
019 146 121	D.1/2x1/2 Dx Art.114S-04-DX	PZ	10	24,70
019 146 123	D.1/2x1/2 Sx Art.114S-04-SX	PZ	10	24,70

Valvola Angolo Doppio
Termostattizzabile Te-Sa
con Manopola



CODICE	MISURA	UM	PZ	€
019 146 126	D.1/2x1/2 Dx Art.105S-045	PZ	10	20,60
019 146 128	D.1/2x1/2 Sx Art.105S-045	PZ	10	19,30

Detentore Angolo Doppio
Termostattizzabile Te-Sa
Bianca



CODICE	MISURA	UM	PZ	€
019 146 045	D.16x1/2x2,00 Art.218HT-16020	PZ	10	6,70
019 146 046	D.16x1/2x2,25 Art.218HT-16022	PZ	10	6,70
019 146 146	D.14x3/4x2,00 Art.208HT-05-14	PZ	10	31,10
019 146 024	D.20x3/4x2,00 Art.217HT-20020	PZ	10	8,30

Adattatore Kit
per Tubo Multistrato
Te-Sa Lucido



CODICE	MISURA	UM	PZ	€
019146060	D.1/2x12	PZ	10	6,70
019146061	D.1/2x14	PZ	10	6,20
019146062	D.1/2x16	PZ	10	2,70

Adattatore Kit
per Tubo Rame Tenuta O-Ring
Te-Sa Lucido





Collettore Te-Sa 2 Vie
con Rubinetto 35° Blu/Rosso

CODICE	MISURA	UM	PZ	€
019146070	D.3/4x1/2 M.F.	PZ	5	16,40



Collettore Te-Sa 3 Vie
con Rubinetto 35° Blu/Rosso

CODICE	MISURA	UM	PZ	€
019146071	D.3/4x1/2 M.F.	PZ	5	24,60



Collettore Te-Sa 4 Vie
con Rubinetto 35° Blu/Rosso

CODICE	MISURA	UM	PZ	€
019146072	D.3/4x1/2 M.F.	PZ	4	32,80



Collettore Te-Sa 2 Vie
Cromato Normale

CODICE	MISURA	UM	PZ	€
019146086	D.3/4x1/2 M.F.	PZ	10	9,00
019146087	D.1" x1/2 M.F.	PZ	10	10,70



Collettore Te-Sa 3 Vie
Cromato Normale

CODICE	MISURA	UM	PZ	€
019146090	D.3/4x1/2 M.F.	PZ	8	12,60
019146091	D.1" x1/2 M.F.	PZ	8	13,40



Collettore Te-Sa 4 Vie
Cromato Normale

CODICE	MISURA	UM	PZ	€
019146094	D.3/4x1/2 M.F.	PZ	6	15,30
019146095	D.1" x1/2 M.F.	PZ	6	17,90



Tappo di Testa Te-Sa
Maschio Terminale
con O-Ring

CODICE	MISURA	UM	PZ	€
019 146 101	D.3/4 Art.213-05	PZ	10	3,60
019 146 102	D.1" Art.213-06	PZ	10	4,40



Tappo di Testa Te-Sa
Femmina Terminale
con O-Ring

CODICE	MISURA	UM	PZ	€
019 146 076	D.3/4 Art.214-05	PZ	10	2,40
019 146 077	D.1" Art.214-06	PZ	10	3,60



Cassetta per Collettori Te-Sa
in Plastica
con Supporti

CODICE	MISURA	UM	PZ	€
019 146 080	209R-01 Cm. 32x24x8	PZ	8	25,70
019 146 081	209R-02 Cm. 40x24x8	PZ	8	27,50
019 146 082	209R-03 Cm. 50x24x8	PZ	8	32,40
019 146 083	209R-04 Cm. 60x24x8	PZ	8	37,50



CODICE	MISURA	UM	PZ	€
019 146 033	D.1/2 Maschio x 3/4 Femmina Art.235-045	PZ	10	3,50

Raccordo Maschio Femmina
Te-Sa Cromato



CODICE	MISURA	UM	PZ	€
019 146 034	Raccordo Trasformazione Te-Sa Cromato D.1/2 Femmina x 3/4 Maschio	PZ	10	7,90

Raccordo Monoblocco
di Trasformazione
Te-Sa Cromato



CODICE	MISURA	UM	PZ	€
019 146 020	D.16x1/2x2,00	PZ	10	3,20
019 146 021	D.16x1/2x2,25	PZ	10	3,20
019 146 022	D.20x3/4x2,00	PZ	10	5,70
019 146 023	D.20x3/4x2,00 Lucido	PZ	10	9,70
019 146 024	D.20x3/4x2,00 Lucido	PZ	10	8,30
019 146 028	D.16x3/4x2,00 Lucido	PZ	10	5,30

Adattatore Kit
per Tubo Multistrato
Te-Sa Cromato



CODICE	MISURA	UM	PZ	€
019 146 023	D.20x3/4x2,00	PZ	10	9,70
019 146 024	D.20x3/4x2,00	PZ	10	8,30

Adattatore Kit
per Tubo Multistrato
Te-Sa Lucido



CODICE	MISURA	UM	PZ	€
019 146 135	D.1/2x10 Art.208-04-10	PZ	10	2,40
019 146 136	D.1/2x12 Art.208-04-12	PZ	10	2,40
019 146 137	D.1/2x14 Art.208-04-14	PZ	10	2,40
019 146 138	D.1/2x16 Art.208-04-16	PZ	10	2,40
019 146 141	D.3/4x14 Art.208-05-14	PZ	10	6,50
019 146 142	D.3/4x16 Art.208-05-16	PZ	10	5,60
019 146 143	D.3/4x18 Art.208-05-18	PZ	10	5,60

Adattatore Kit
per Tubo Rame
Tenuta O-Ring
Te-Sa Cromato



CODICE	MISURA	UM	PZ	€
019 146 145	D.3/4x12 Art.208HT-05-12	PZ	10	28,70
019 146 146	D.3/4x14 Art.208HT-05-14	PZ	10	31,10
019 146 060	D.1/2x12 Art.207HT-04-12	PZ	10	6,70
019 146 061	D.1/2x14 Art.207HT-04-14	PZ	10	6,20
019 146 062	D.1/2x16 Art.207HT-04-16	PZ	10	2,70

Adattatore Kit
per Tubo Rame
Tenuta O-Ring
Te-Sa Lucido





Gruppo distribuzione diretta per centrale termica

CODICE	MISURA	UM	PZ	€
019 146 160	Dx D.1"-25/1-7-130	PZ	1	723,20
019 146 161	Sx D.1"-25/1-7-130	PZ	1	723,20



Gruppo regolazione punto fisso miscelatore termostatico

CODICE	MISURA	UM	PZ	€
019 146 165	Dx1"-25/1-7-130-20-43°	PZ	1	931,90
019 146 166	Sx1"-25/1-7-130-20-43°	PZ	1	931,90
019 146 167	Dx1"-25/1-7-130-20-65°	PZ	1	931,90
019 146 168	Sx1"-25/1-7-130-20-65°	PZ	1	931,90



Gruppo regolazione Motorizzata Con Valvola Miscelatrice a 3 Vie

CODICE	MISURA	UM	PZ	€
019 146 170	Dx.1"-25/1-7-130 - 230V	PZ	1	1076,20
019 146 171	Sx.1"-25/1-7-130 - 230V	PZ	1	1076,20
019 146 172	Dx.1"-25/1-7-130 - 24V	PZ	1	1104,30
019 146 173	Sx.1"-25/1-7-130 - 24V	PZ	1	1104,30
019 146 174	Dx.1"-25/1-7-130 - 24/10V	PZ	1	1218,50
019 146 175	Sx.1"-25/1-7-130 - 24/10V	PZ	1	1218,50



Gruppo Regolazione Climatico Con Valvola Miscelatrice a 3 Vie Cen.

CODICE	MISURA	UM	PZ	€
019 146 178	Dx.1"-25/1-7-130	PZ	1	1564,00
019 146 179	Sx.1"-25/1-7-130	PZ	1	1564,00



Separatore Idraulico Inox Con Kit Collettore Complanare Riscaldamento

CODICE	MISURA	UM	PZ	€
019 146 180	D.1"M.2+1	PZ	1	707,60
019 146 181	D.1"M.2+2+1	PZ	1	878,30
019 146 182	D.1"M.3+1	PZ	1	855,20



Separatore Idraulico Inox per Riscaldamento e Raffrescamento

CODICE	MISURA	UM	PZ	€
019 146 185	D.1"/4 M.x1"1/4F	PZ	1	262,80



Collettore Distribuzione Complanare Inox per Riscaldamento e Raffrescamento 3 Vie

CODICE	MISURA	UM	PZ	€
019 146 190	D.1"M.2+1	PZ	1	400,90
019 146 191	D.1"M.3+1	PZ	1	544,00

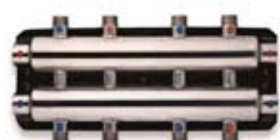

Collettore Distribuzione Complanare Inox per Riscaldamento

CODICE	MISURA	UM	PZ	€
019 146 195	D.1"M.2+2+1	PZ	1	570,20



CODICE	MISURA	UM	PZ	€
019146200	D.1"-25/1-7-180	PZ	1	584,90

Gruppo distribuzione diretta centrale termica



CODICE	MISURA	UM	PZ	€
019146205	25/1-7-180-20-43°	PZ	1	855,30
019146206	25/1-7-180-20-65°	PZ	1	855,30

Gruppo regolazione punto fisso miscelatore termostatico



CODICE	MISURA	UM	PZ	€
019146210	Dx.1"-25/1-7-180	PZ	1	803,40
019146211	Sx.1"-25/1-7-180	PZ	1	803,40

Gruppo di regolazione motorizzabile, completo di valvola miscelatrice a tre vie



CODICE	MISURA	UM	PZ	€
019146214	Dx.1"-25/1-7-180 - 230V	PZ	1	965,40
019146215	Sx.1"-25/1-7-180 - 230V	PZ	1	965,40
019146216	Dx.1"-25/1-7-180 - 24V	PZ	1	965,40
019146217	Sx.1"-25/1-7-180 - 24V	PZ	1	965,40
019146218	Dx.1"-25/1-7-180 - 24/10V	PZ	1	1093,30
019146219	Sx.1"-25/1-7-180 - 24/10V	PZ	1	1093,30

Gruppo di regolazione motorizzato, completo di valvola miscelatrice a tre vie



CODICE	MISURA	UM	PZ	€
019146221	D.1"M.2+1	PZ	1	645,70
019146222	D.1"M.3-1	PZ	1	684,20
019146223	D.1"M.4-1	PZ	1	705,80

Separatore idraulico e collettore di distribuzione in acciaio al carbonio zincato



CODICE	MISURA	UM	PZ	€
019146225	D.1"/4 M.x1"/4F	PZ	1	196,20

Separatore Idraulico Acciaio Carbonio per Riscaldamento



CODICE	MISURA	UM	PZ	€
019146230	D.1"M.2+1	PZ	1	405,50
019146231	D.1"M.3+1	PZ	1	443,50
019146232	D.1"M.4+1	PZ	1	465,50

Collettore Distribuzione Complanare in acciaio al carbonio zincato



CODICE	MISURA	UM	PZ	€
019146235	D.1"F	PZ	1	436,10
019146236	D.1"1/4 F	PZ	1	499,20
019146237	D.1"1/2 F	PZ	1	516,20
019146238	D.2" F.	PZ	1	772,00

Separatore idraulico Inox per riscaldamento e raffreddamento con isolante in PE-X



CODICE	MISURA	UM	PZ	€
019146240	D.1"F.	PZ	1	333,50
019146241	D.1"1/4F	PZ	1	387,50
019146242	D.1"1/2F	PZ	1	404,50
019146243	D.2"F.	PZ	1	647,30

Separatore idraulico Inox per riscaldamento e raffreddamento





Collettore Distribuzione
Premontato Acciaio Inox
Completo

CODICE	MISURA	UM	PZ	€
019146250	D.1"x 2	PZ	1	149,90
019146251	D.1"x 3	PZ	1	187,50
019146252	D.1"x 4	PZ	1	228,40
019146253	D.1"x 5	PZ	1	271,40
019146254	D.1"x 6	PZ	1	311,90
019146255	D.1"x 7	PZ	1	353,20
019146256	D.1"x 8	PZ	1	394,20
019146257	D.1"x 9	PZ	1	434,50
019146258	D.1"x 10	PZ	1	474,40
019146259	D.1"x 11	PZ	1	517,00
019146260	D.1"x 12	PZ	1	556,60



Cassetta per Collettori
Lamiera Con Supporti
Te-Sa

CODICE	MISURA	UM	PZ	€
019146270	mm 400x450x(110-150)	PZ	1	105,00
019146271	mm 600x450x(110-150)	PZ	1	117,60
019146272	mm 800x450x(110-150)	PZ	1	132,10
019146273	mm1000x450x(110-150)	PZ	1	146,70
019146274	mm1200x450x(110-150)	PZ	1	166,70



Base per Cassetta
per Collettori in Lamiera
Te-Sa

CODICE	MISURA	UM	PZ	€
019146280	mm 400x(150-260)100	PZ	1	43,90
019146281	mm 600x(150-260)100	PZ	1	48,30
019146282	mm 800x(150-260)100	PZ	1	52,80
019146283	mm 1000x(150-260)100	PZ	1	57,30
019146284	mm 1200x(150-260)100	PZ	1	68,60



Valvola a Farfalla
Bocchettonata Con
Termometro Coppia M/F

CODICE	MISURA	UM	PZ	€
019146290	M.F. D.1"x1"	PZ	1	83,30



Valvola di Zona Motorizzata
Te-Sa 2 Vie a Sfera M/M
Con Bocchettone

CODICE	MISURA	UM	PZ	€
019146300	D.1/2	PZ	1	44,30
019146301	D.3/4	PZ	1	46,40
019146302	D.1"	PZ	1	63,50



Valvola di Zona Motorizzata
Te-Sa 2 Vie a Sfera M/F.
Con Bocchettone

CODICE	MISURA	UM	PZ	€
019146310	D.1/2	PZ	1	39,70
019146311	D.3/4	PZ	1	42,00
019146312	D.1"	PZ	1	55,00



Valvola di Zona Motorizzata
Te-Sa 3 Vie a Sfera M/M
Con Bocchettone

CODICE	MISURA	UM	PZ	€
019146320	D.1/2	PZ	1	50,70
019146321	D.3/4	PZ	1	53,60
019146322	D.1"	PZ	1	77,40



Servocomando
per Valvole di Zona Te-Sa
Micro Interruttore Ausiliario

CODICE	MISURA	UM	PZ	€
019146335	230V	PZ	1	176,20
019146336	24V	PZ	1	176,20



CODICE	MISURA	UM	PZ	€
019 149 011	D.12x1	ML	5	*
019 149 012	D.14x1	ML	5	*
019 149 045	D.15x1	ML	5	*
019 149 013	D.15x1	ML	5	*
019 149 014	D.18x1	ML	5	*
019 149 015	D.22x1	ML	5	*
019 149 016	D.28x1	ML	5	*
019 149 017	D.35x1	ML	5	*
019 149 018	D.42x1,5	ML	5	*
019 149 019	D.54x2	ML	5	*

Tubo in Rame Sanco
Verghe da Mt 5



CODICE	MISURA	UM	PZ	€
019 149 001	D.12x1	ML	50	*
019 149 002	D.14x1	ML	50	*
019 149 007	D.16x1	ML	50	*
019 149 003	D.18x1	ML	50	*
019 149 004	D.22x1	ML	25	*

Tubo in Rame Sanco
Rivestito Pvc Smisol Più

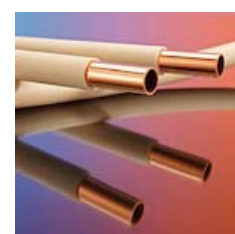

CODICE	MISURA	UM	PZ	€
019 149 005	D.12x1	ML	50	*
019 149 006	D.14x1	ML	50	*
019 149 008	D.16x1	ML	50	*
019 149 009	D.18x1	ML	50	*
019 149 010	D.22x1	ML	25	*

Tubo in Rame Sanco
Rivestito Preisolato
Smisol One

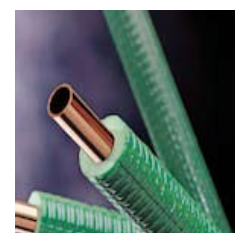

CODICE	MISURA	UM	PZ	€
019 149 020	D.1/4x0.8 - D.6,35 x0,8	ML	50	*
019 149 021	D.3/8x0.8 - D.9,52 x0,8	ML	50	*
019 149 022	D.1/2x0.8 - D.12,70x0,8	ML	50	*
019 149 023	D.5/8x0.8 - D.15,87x0,8	ML	50	*

Tubo in Rame Sanco
Preisolato Condizionamento
Wicu Clim



CODICE	MISURA	UM	PZ	€
019 149 070	D.1/4x0.7 - D.6,35 x0,7	ML	50	*
019 149 071	D.3/8x0.7 - D.9,52 x0,7	ML	50	*
019 149 072	D.1/2x0.7 - D.12,70x0,7	ML	50	*

Tubo in Rame Sanco
Preisolato Condizionamento
Smisol Clim



CODICE	MISURA	UM	PZ	€
019 149 026	D.1/4x1 - D.6,35 x1	ML	50	*
019 149 027	D.3/8x1 - D.9,52 x1	ML	50	*
019 149 028	D.1/2x1 - D.12,70x1	ML	50	*

Tubo in Rame Sanco
Preisolato Condizionamento
Wicu Clim



CODICE	MISURA	UM	PZ	€
019 149 035	D.14x1	ML	50	*
019 149 036	D.16x1	ML	50	*
019 149 037	D.18x1	ML	50	*
019 149 038	D.22x1	ML	50	*

Tubo in Rame Sanco
Preisolato Refrigerazione
Wicu Frio



CODICE	MISURA	UM	PZ	€
019 149 039	D.12x1	ML	50	*
019 149 040	D.14x1	ML	50	*
019 149 041	D.16x1	ML	50	*
019 149 042	D.18x1	ML	50	*

Tubo in Rame Sanco
Inguainato Polietilene
Smisol Tek Gas

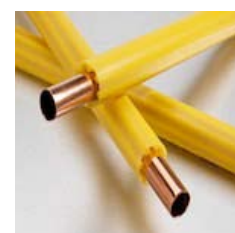



Tubo Rame Kopper®
ICE Isoclima Preisolato
Condizionamento

CODICE	MISURA	UM	PZ	€
019 030 001	D.1/4x0.8 - D.6,35 x0,8	ML	50	*
019 030 002	D.3/8x0.8 - D.9,52 x0,8	ML	50	*
019 030 003	D.1/2x0.8 - D.12,70x0,8	ML	50	*
019 030 004	D.5/8x0.8 - D.15,87x0,8	ML	25	*



Tubo Rame Kopper®
ICE Isoclima Preisolato
Condizionamento

CODICE	MISURA	UM	PZ	€
019 030 006	D.1/4x1 - D.6,35 x1	ML	50	*
019 030 007	D.3/8x1 - D.9,52 x1	ML	50	*
019 030 008	D.1/2x1 - D.12,70x1	ML	50	*



Tubo Rame Kopper®
ROD Isoclima
Verghe da ML5

CODICE	MISURA	UM	PZ	€
019 030 010	D.12x1	ML	5	*
019 030 011	D.14x1	ML	5	*
019 030 012	D.15x1	ML	5	*
019 030 013	D.16x1	ML	5	*
019 030 014	D.18x1	ML	5	*
019 030 015	D.22x1	ML	5	*
019 030 016	D.28x1	ML	5	*
019 030 017	D.35x1	ML	5	*
019 030 018	D.42x1,5	ML	5	*
019 030 019	D.54x2	ML	5	*



Tubo Rame Kopper® PVC/
Isoclima Rivestito Pvc

CODICE	MISURA	UM	PZ	€
019 030 025	D.12x1	ML	50	*
019 030 026	D.14x1	ML	50	*
019 030 027	D.16x1	ML	50	*
019 030 028	D.18x1	ML	50	*
019 030 029	D.22x1	ML	25	*



Tubo Rame Kopper®
373 Isoclima Rivestito

CODICE	MISURA	UM	PZ	€
019 030 030	D.12x1	ML	50	*
019 030 031	D.14x1	ML	50	*
019 030 032	D.16x1	ML	50	*
019 030 033	D.18x1	ML	50	*
019 030 034	D.22x1	ML	25	*



Tubo Rame Kopper®
ATLAS Isoclima Gas
(Per Interni) Riv.Politilene

CODICE	MISURA	UM	PZ	€
019 030 050	D.12x1	ML	50	*
019 030 051	D.14x1	ML	50	*
019 030 052	D.16x1	ML	50	*
019 030 053	D.18x1	ML	50	*



CODICE	MISURA	UM	PZ	€
019153040	Gpl-Metano 50401	PZ	1	166,60

Contatore Gas Volumetrico
a Parete Deformabile



CODICE	MISURA	UM	PZ	€
019153041	1"1/4"-1"x1"Guarniz.	PZ	1	67,00

Mensola per Contatore Gas
Con Rubinetto Zanca Attorci



CODICE	MISURA	UM	PZ	€
019 153 011	per Gpl Chiave D.25x10	PZ	5	6,60

Regolatore Gas
Singolo Stadio Kg 1,1



CODICE	MISURA	UM	PZ	€
019 153 001	per Gpl Chiave D.25x3/8 F.	PZ	1	15,10

Regolatore Gas
Singolo Stadio Kg 4



CODICE	MISURA	UM	PZ	€
019 153 006	per Gpl Chiave D.25x1/2 F. - Kg 7	PZ	1	29,30
019 153 002	per Gpl Chiave D.25x1/2 F. - Kg 10	PZ	1	30,90

Regolatore Gas
Singolo Stadio



CODICE	MISURA	UM	PZ	€
019 153 008	Gpl Alta Pressione D.1/4x3/8 F.	PZ	1	23,40

Regolatore Gas
Singolo Stadio Kg 8
Alta Pressione
con Portagomma



CODICE	MISURA	UM	PZ	€
019 153 009	Gpl Alta Pressione D.25x3/8 Femmina - Kg. 30	PZ	1	81,30
019 153 015	D.25x3/8 Femmina Completo di Manometro e Valvola Sicurezza - Kg 40	PZ	1	89,40

Regolatore Gas
Singolo Stadio Kg 30



CODICE	MISURA	UM	PZ	€
001072024	Destro Sinistro D.1/2	PZ	10	2,60

Raccordo Ottone Giallo
Niples Maschio



CODICE	MISURA	UM	PZ	€
001072025	Filettato D.1/4x1/2Sx	PZ	10	2,90

Raccordo Dado Folle
Iniettore Ottone Giallo





Manometro per Gas Gpl

CODICE	MISURA	UM	PZ	€
019 153 012	Taratura da 0-25 bar a Secco D.1/4	PZ	1	8,20



Centralina Gas Bombola Con Valvola Sicurezza e manometro

CODICE	MISURA	UM	PZ	€
019 153 003	2 Attacchi	PZ	1	75,20
019 153 004	3 Attacchi	PZ	1	95,50
019 153 007	4 Attacchi	PZ	1	121,90



Minicentralina Gas Bombola Con Valvola Manometro e Rubinetti

CODICE	MISURA	UM	PZ	€
019 153 005	Taratura da 0-25 bar a Secco D.1/4 Kg 4 con Flex	PZ	1	58,10
019 153 010	Taratura da 0-25 bar a Secco D.1/4 Kg 10 senza Flex	PZ	1	61,00



Minicentralina Gas Bombola Doppio Stadio Con Valvola Manometro e Rubinetto

CODICE	MISURA	UM	PZ	€
019 153 013	Minicentralina Gas Bombola Doppio Stadio C/Valvola Man.e Rub.Kg12-4	PZ	1	95,50
019 153 014	Minicentralina Gas Bombola Doppio Stadio C/Valvola Man.e Rub.Kg12-10	PZ	1	111,80



Tubo Gomma per Gas Metano

CODICE	MISURA	UM	PZ	€
019 153 050	D.20 x 13 Rotolo da 50 Mt	ML	50	2,40



Tubo Gomma per Gas Gpl

CODICE	MISURA	UM	PZ	€
019 153 051	D.13 x 8 Rotolo da 50 Mt	ML	50	1,20



Rilevatore Fughe Gas Completo Elettrovalvola N.A.

CODICE	MISURA	UM	PZ	€
019 153 020	D.1/2 Metano	PZ	1	213,80
019 153 021	D.3/4 Metano	PZ	1	213,80
019 153 022	D.1" Metano	PZ	1	217,00



Rilevatore Fughe Gas Completo Elettrovalvola N.A.

CODICE	MISURA	UM	PZ	€
019 153 025	D.1/2 Gpl	PZ	1	213,80
019 153 026	D.3/4 Gpl	PZ	1	214,80
019 153 027	D.1" Gpl	PZ	1	247,20



Rilevatore Fughe Gas con Allarme Acustico a Relè

CODICE	MISURA	UM	PZ	€
019 153 030	Metano	PZ	1	158,60
019 153 031	Gpl	PZ	1	158,60



CODICE	MISURA	UM	PZ	€
025 147 001	C/Manichetta Mt20	PZ	1	201,10
025 147 002	C/Manichetta Mt25	PZ	1	218,70
025 147 003	C/Manichetta Mt30	PZ	1	236,70

Cassetta Antincendio ad Incasso Verniciata Uni45



CODICE	MISURA	UM	PZ	€
025 147 007	C/Manichetta Mt20	PZ	1	315,20
025 147 008	C/Manichetta Mt25	PZ	1	225,00
025 147 009	C/Manichetta Mt30	PZ	1	390,10

Cassetta Antincendio Esterna Verniciata Uni45



CODICE	MISURA	UM	PZ	€
025 147 004	C/Manichetta Mt20	PZ	1	325,10
025 147 005	C/Manichetta Mt25	PZ	1	347,60
025 147 006	C/Manichetta Mt30	PZ	1	370,40

Cassetta Antincendio ad Incasso Verniciata Uni70



CODICE	MISURA	UM	PZ	€
025 147 010	C/Manichetta Mt20	PZ	1	278,30
025 147 011	C/Manichetta Mt25	PZ	1	298,70
025 147 012	C/Manichetta Mt30	PZ	1	319,80

Cassetta Antincendio ad Esterna Verniciata Uni70



CODICE	MISURA	UM	PZ	€
025 147 013	D.2" Orizzontale	PZ	1	334,10
025 147 014	D.2"1/2 Orizzontale	PZ	1	213,10

Gruppo Attacchi Filettati in Linea per Motopompa Uni70





Tubo Acciaio Inox Aisi 304
Monoparete
Senza Guarnizione 1 Mt

CODICE	MISURA	UM	PZ	€
028 104 001	D.80 x1000	PZ	1	17,50
028 104 002	D.100x1000	PZ	1	22,90
028 104 003	D.120x1000	PZ	1	25,20
028 104 004	D.130x1000	PZ	1	27,20
028 104 005	D.140x1000	PZ	1	28,70
028 104 006	D.150x1000	PZ	1	29,00
028 104 007	D.160x1000	PZ	1	31,90
028 104 008	D.180x1000	PZ	1	33,20
028 104 009	D.200x1000	PZ	1	34,20
028 104 010	D.250x1000	PZ	1	43,00
028 104 011	D.300x1000	PZ	1	51,10



Tubo Acciaio Inox Aisi 304
Monoparete
Senza Guarnizione 0,5 Mt

CODICE	MISURA	UM	PZ	€
028 104 015	D.80 x500	PZ	1	10,40
028 104 016	D.100x500	PZ	1	13,20
028 104 017	D.120x500	PZ	1	14,50
028 104 018	D.130x500	PZ	1	15,70
028 104 019	D.140x500	PZ	1	16,50
028 104 020	D.150x500	PZ	1	16,70
028 104 021	D.160x500	PZ	1	18,40
028 104 022	D.180x500	PZ	1	19,10
028 104 023	D.200x500	PZ	1	19,90
028 104 024	D.250x500	PZ	1	24,30
028 104 025	D.300x500	PZ	1	29,40



Tubo Acciaio Inox Aisi 304
Monoparete
Senza Guarnizione 0,25Mt

CODICE	MISURA	UM	PZ	€
028 104 030	D.80 x250	PZ	1	6,00
028 104 031	D.100x250	PZ	1	7,60
028 104 032	D.120x250	PZ	1	8,40
028 104 033	D.130x250	PZ	1	9,00
028 104 034	D.140x250	PZ	1	10,70
028 104 035	D.150x250	PZ	1	9,60
028 104 036	D.160x250	PZ	1	11,90
028 104 037	D.180x250	PZ	1	11,00
028 104 038	D.200x250	PZ	1	11,50
028 104 039	D.250x250	PZ	1	14,00
028 104 040	D.300x250	PZ	1	19,00



Tubo Telescopico Acciaio
Inox Aisi 304 Monoparete
Senza Guarnizione

CODICE	MISURA	UM	PZ	€
028 104 135	D. 80	PZ	1	29,70
028 104 136	D.100	PZ	1	32,30
028 104 137	D.120	PZ	1	38,10
028 104 138	D.130	PZ	1	39,70
028 104 139	D.140	PZ	1	38,30
028 104 140	D.150	PZ	1	39,70
028 104 141	D.160	PZ	1	44,80
028 104 142	D.180	PZ	1	44,50
028 104 143	D.200	PZ	1	47,80
028 104 144	D.250	PZ	1	59,30
028 104 145	D.300	PZ	1	74,00

SETTORE 028
RISCALDAMENTO



CODICE	MISURA	UM	PZ	€
028 104 400	D.80	PZ	1	30,00
028 104 401	D.100	PZ	1	35,60
028 104 402	D.120	PZ	1	37,40
028 104 403	D.130	PZ	1	44,90
028 104 404	D.140	PZ	1	48,60
028 104 405	D.150	PZ	1	46,60
028 104 406	D.160	PZ	1	54,20
028 104 407	D.180	PZ	1	55,70
028 104 408	D.200	PZ	1	59,80
028 104 409	D.250	PZ	1	74,90
028 104 410	D.300	PZ	1	104,20

Tubo Flessibile Acciaio Inox
Interno Liscio 316L



CODICE	MISURA	UM	PZ	€
028 104 600	D.80x3 MT	PZ	1	14,50
028 104 601	D.100x3 MT	PZ	1	18,10
028 104 602	D.120x3 MT	PZ	1	21,80
028 104 603	D.130x3 MT	PZ	1	23,60
028 104 604	D.140x3 MT	PZ	1	25,30
028 104 605	D.150x3 MT	pz	1	27,20
028 104 606	D.160x3 MT	PZ	1	26,70
028 104 607	D.180x3 MT	PZ	1	32,60
028 104 608	D.200x3 MT	pz	1	36,20
028 104 609	D.250x3 MT	pz	1	45,30
028 104 610	D.300x3 MT	PZ	1	54,30

Tubo Flessibile
Alluminio Estensibile
Corrugato Naturale



CODICE	MISURA	UM	PZ	€
028 104 445	D.80	PZ	1	9,60
028 104 446	D.100	PZ	1	10,80
028 104 447	D.120	PZ	1	9,00
028 104 448	D.130	PZ	1	13,00
028 104 449	D.140	PZ	1	13,00
028 104 450	D.150	PZ	1	10,40
028 104 451	D.160	PZ	1	17,40
028 104 452	D.180	PZ	1	17,30
028 104 453	D.200	PZ	1	12,40
028 104 454	D.250	PZ	1	21,70
028 104 455	D.300	PZ	1	26,00

Tronchetto di Giunzione Flex
Rigido Acciaio Inox Aisi304
Senza Guarnizione



CODICE	MISURA	UM	PZ	€
028 104 460	D.80	PZ	1	6,50
028 104 461	D.100	PZ	1	7,00
028 104 462	D.120	PZ	1	8,10
028 104 463	D.130	PZ	1	8,30
028 104 464	D.140	PZ	1	9,00
028 104 465	D.150	PZ	1	10,20
028 104 466	D.160	PZ	1	10,30
028 104 467	D.180	PZ	1	11,10
028 104 468	D.200	PZ	1	12,50
028 104 469	D.250	PZ	1	15,20
028 104 470	D.300	PZ	1	16,70

Tronchetto di Giunzione Flex
Flex Acciaio Inox Aisi 304
Senza Guarnizione





Gomito 30° Acciaio Inox
Aisi 304 Monoparete
Senza Guarnizione

CODICE	MISURA	UM	PZ	€
028 104 041	D. 80	PZ	1	16,80
028 104 042	D.200	PZ	1	24,70
028 104 043	D.300	PZ	1	30,70



Gomito 45° Acciaio Inox
Aisi 304 Monoparete
Senza Guarnizione

CODICE	MISURA	UM	PZ	€
028 104 045	D. 80	PZ	1	18,10
028 104 046	D.100	PZ	1	19,20
028 104 047	D.120	PZ	1	19,90
028 104 048	D.130	PZ	1	20,70
028 104 049	D.140	PZ	1	21,20
028 104 050	D.150	PZ	1	23,30
028 104 051	D.160	PZ	1	26,40
028 104 052	D.180	PZ	1	25,20
028 104 053	D.200	PZ	1	26,10
028 104 054	D.250	PZ	1	33,00
028 104 055	D.300	PZ	1	34,60



Gomito 90° Acciaio Inox
Aisi 304 Monoparete
Senza Guarnizione

CODICE	MISURA	UM	PZ	€
028 104 060	D. 80	PZ	1	21,80
028 104 061	D.100	PZ	1	24,10
028 104 062	D.120	PZ	1	24,90
028 104 063	D.130	PZ	1	26,40
028 104 064	D.140	PZ	1	29,80
028 104 065	D.150	PZ	1	32,10
028 104 066	D.160	PZ	1	33,50
028 104 067	D.180	PZ	1	39,00
028 104 068	D.200	PZ	1	39,60
028 104 069	D.250	PZ	1	44,10
028 104 070	D.300	PZ	1	53,90



Tee 90° FFM Acciaio Inox
Aisi 304 Monoparete
Senza Guarnizione

CODICE	MISURA	UM	PZ	€
028 104 075	D. 80	PZ	1	29,80
028 104 102	D. 80	PZ	1	29,80
028 104 076	D.100	PZ	1	31,30
028 104 077	D.120	PZ	1	33,00
028 104 078	D.130	PZ	1	37,30
028 104 079	D.140	PZ	1	38,00
028 104 080	D.150	PZ	1	39,00
028 104 081	D.160	PZ	1	44,80
028 104 082	D.180	PZ	1	47,90
028 104 083	D.200	PZ	1	57,10
028 104 084	D.250	PZ	1	70,40
028 104 085	D.300	PZ	1	80,70

SETTORE 028
RISCALDAMENTO



CODICE	MISURA	UM	PZ	€
028 104 090	D. 80	PZ	1	51,90
028 104 091	D.100	PZ	1	58,50
028 104 092	D.120	PZ	1	61,40
028 104 093	D.130	PZ	1	77,00
028 104 094	D.140	PZ	1	72,20
028 104 095	D.150	PZ	1	73,50
028 104 096	D.160	PZ	1	80,70
028 104 097	D.180	PZ	1	77,40
028 104 098	D.200	PZ	1	89,50
028 104 099	D.250	PZ	1	128,50
028 104 100	D.300	PZ	1	147,90

Braga 135° FMM Acciaio
Inox Aisi 304 Monoparete
Senza Guarnizione



CODICE	MISURA	UM	PZ	€
028 104 105	D. 80	PZ	1	20,80
028 104 106	D.100	PZ	1	21,70
028 104 107	D.120	PZ	1	23,00
028 104 108	D.130	PZ	1	24,40
028 104 109	D.140	PZ	1	24,70
028 104 110	D.150	PZ	1	24,80
028 104 111	D.160	PZ	1	26,40
028 104 112	D.180	PZ	1	28,20
028 104 113	D.200	PZ	1	33,80
028 104 114	D.250	PZ	1	40,20
028 104 115	D.300	PZ	1	53,60

Tappo Scarico Condensa
Femmina
Acciaio Inox Aisi 304
Monoparete
Senza Guarnizione



CODICE	MISURA	UM	PZ	€
028 104 120	D. 80	PZ	1	18,70
028 104 121	D.100	PZ	1	31,90
028 104 122	D.120	PZ	1	22,40
028 104 123	D.130	PZ	1	51,40
028 104 124	D.140	PZ	1	27,80
028 104 125	D.150	PZ	1	27,80
028 104 126	D.160	PZ	1	29,70
028 104 127	D.180	PZ	1	31,70
028 104 128	D.200	PZ	1	38,00
028 104 129	D.250	PZ	1	36,20
028 104 130	D.300	PZ	1	72,90

Tappo Ispezione Maschio
Acciaio Inox Aisi 304
Monoparete
Senza Guarnizione



CODICE	MISURA	UM	PZ	€
028 104 150	D. 80	PZ	1	77,70
028 104 151	D.100	PZ	1	79,10
028 104 152	D.120	PZ	1	79,90
028 104 153	D.130	PZ	1	81,00
028 104 154	D.140	PZ	1	81,80
028 104 155	D.150	PZ	1	83,00
028 104 156	D.160	PZ	1	90,10
028 104 157	D.180	PZ	1	91,60
028 104 158	D.200	PZ	1	122,80
028 104 159	D.250	PZ	1	141,10
028 104 160	D.300	PZ	1	148,30

Modulo D'Ispezione Acciaio
Inox Aisi 304 Monoparete
Senza Guarnizione





Riduzione ed Aumento Inox
Aisi 304 Monoparete
Senza Guarnizione

FEMMINA



MASCHIO

FEMMINA



MASCHIO

CODICE	MISURA	UM	PZ	€
028 104 195	D.100- 80	PZ	1	31,10
028 104 196	D.120- 80	PZ	1	32,30
028 104 197	D.120-100	PZ	1	32,30
028 104 198	D.130- 80	PZ	1	35,60
028 104 199	D.130-100	PZ	1	32,90
028 104 200	D.130-120	PZ	1	32,90
028 104 201	D.140- 80	PZ	1	33,40
028 104 202	D.140-100	PZ	1	33,40
028 104 203	D.140-120	PZ	1	36,20
028 104 204	D.140-130	PZ	1	36,20
028 104 205	D.150- 80	PZ	1	36,80
028 104 206	D.150-100	PZ	1	34,00
028 104 207	D.150-120	PZ	1	34,00
028 104 208	D.150-130	PZ	1	34,00
028 104 209	D.150-140	PZ	1	34,00
028 104 210	D.160-100	PZ	1	34,60
028 104 211	D.160-120	PZ	1	34,60
028 104 212	D.160-130	PZ	1	40,20
028 104 213	D.160-140	PZ	1	37,40
028 104 214	D.160-150	PZ	1	34,60
028 104 216	D.180-120	PZ	1	43,80
028 104 218	D.180-140	PZ	1	39,10
028 104 219	D.180-150	PZ	1	39,10
028 104 220	D.180-160	PZ	1	39,10
028 104 225	D.200-120	PZ	1	40,50
028 104 226	D.200-130	PZ	1	40,50
028 104 227	D.200-140	PZ	1	40,50
028 104 228	D.200-150	PZ	1	40,50
028 104 229	D.200-160	PZ	1	40,50
028 104 230	D.200-180	PZ	1	40,50
028 104 240	D.250-150	PZ	1	47,10
028 104 241	D.250-160	PZ	1	51,00
028 104 242	D.250-180	PZ	1	47,10
028 104 243	D.250-200	PZ	1	47,10
028 104 246	D.300-160	PZ	1	54,80
028 104 247	D.300-180	PZ	1	54,80
028 104 248	D.300-200	PZ	1	54,80
028 104 251	D.300-250	PZ	1	50,60

Tramoggia Inox Aisi 304
Monoparete
Senza Guarnizione



CODICE	MISURA	UM	PZ	€
028 104 260	D.200x200-150	PZ	1	82,20
028 104 261	D.200x200-160	PZ	1	75,20
028 104 262	D.200x200-180	PZ	1	76,70
028 104 263	D.200x200-200	PZ	1	65,80
028 104 264	D.250x250-160	PZ	1	75,90
028 104 265	D.250x250-180	PZ	1	78,10
028 104 266	D.250x250-200	PZ	1	71,60
028 104 269	D.300x300-180	PZ	1	74,00
028 104 270	D.300x300-200	PZ	1	79,60



CODICE	MISURA	UM	PZ	€
028 104 165	D.80	PZ	1	48,50
028 104 166	D.100	PZ	1	51,10
028 104 167	D.120	PZ	1	55,30
028 104 168	D.130	PZ	1	46,90
028 104 169	D.140	PZ	1	63,10
028 104 170	D.150	PZ	1	65,50
028 104 171	D.160	PZ	1	72,10
028 104 172	D.180	PZ	1	78,30
028 104 173	D.200	PZ	1	75,70
028 104 174	D.250	PZ	1	119,10
028 104 175	D.300	pz	1	108,50

Piastra Base Acciaio Inox
Aisi 304 Monoparete
Senza Guarnizione



CODICE	MISURA	UM	PZ	€
028 104 180	D.80	PZ	1	35,80
028 104 181	D.100	PZ	1	37,80
028 104 182	D.120	PZ	1	40,50
028 104 183	D.130	PZ	1	42,30
028 104 184	D.140	PZ	1	47,80
028 104 185	D.150	PZ	1	46,90
028 104 186	D.160	PZ	1	54,20
028 104 187	D.180	PZ	1	58,10
028 104 188	D.200	PZ	1	68,60
028 104 189	D.250	PZ	1	99,10
028 104 190	D.300	PZ	1	115,20

Piastra Intermedia Acciaio
Inox Aisi 304 Monoparete
Senza Guarnizione



CODICE	MISURA	UM	PZ	€
028 104 280	D.200x200-150	PZ	1	53,00
028 104 281	D.200X200-160	PZ	1	48,90
028 104 282	D.200X200-180	PZ	1	48,90
028 104 283	D.200X200-200	PZ	1	60,20
028 104 284	D.250X250-160	PZ	1	57,90
028 104 285	D.250X250-180	PZ	1	57,70
028 104 286	D.250X250-200	PZ	1	53,20
028 104 289	D.250X250-250	PZ	1	53,20
028 104 290	D.300X300-180	PZ	1	59,20
028 104 291	D.300X300-200	PZ	1	59,20
028 104 293	D.300X300-250	PZ	1	59,20
028 104 292	D.300X300-300	PZ	1	64,20

Riduzione Quadro Tonda
Inox Aisi 304 Monoparete
Senza Guarnizione



CODICE	MISURA	UM	PZ	€
028 104 295	D.80	PZ	1	14,70
028 104 296	D.100	PZ	1	17,70
028 104 297	D.120	PZ	1	21,30
028 104 298	D.130	PZ	1	21,20
028 104 299	D.140	PZ	1	24,50
028 104 300	D.150	PZ	1	24,90
028 104 301	D.160	PZ	1	26,00
028 104 302	D.180	PZ	1	29,00
028 104 303	D.200	PZ	1	30,40
028 104 304	D.250	PZ	1	35,10
028 104 305	D.300	PZ	1	41,90

Cappello Cinese Base Tonda
Acciaio Inox Aisi304
Monoparete
Senza Guarnizione





Cappello Cinese Base
Quadra Acciaio Inox Aisi304
Monoparete
Senza Guarnizione

CODICE	MISURA	UM	PZ	€
028 104 310	D.170x170	PZ	1	32,20
028 104 311	D.200x200	PZ	1	40,60
028 104 312	D.220x220	PZ	1	44,90
028 104 313	D.250x250	PZ	1	52,40
028 104 314	D.270x270	PZ	1	56,40
028 104 315	D.300x300	PZ	1	56,60



Cappello Pappagallo Base
Tonda Acciaio Inox Aisi304
Monoparete
Senza Guarnizione

CODICE	MISURA	UM	PZ	€
028 104 320	D.100	PZ	1	49,90
028 104 321	D.120	PZ	1	51,30
028 104 322	D.130	PZ	1	51,30
028 104 323	D.140	PZ	1	57,00
028 104 324	D.150	PZ	1	56,60
028 104 325	D.160	PZ	1	64,10
028 104 326	D.180	PZ	1	69,20
028 104 327	D.200	PZ	1	65,70
028 104 330	D.250	PZ	1	71,00
028 104 331	D.300	PZ	1	81,20



Cappello Pappagallo Base
Quadra Acciaio Inox Aisi304
Senza Guarnizione

CODICE	MISURA	UM	PZ	€
028 104 335	D.170x170	PZ	1	69,70
028 104 336	D.200x200	PZ	1	76,20
028 104 337	D.220x220	PZ	1	78,90
028 104 338	D.250x250	PZ	1	84,50
028 104 339	D.270x270	PZ	1	86,60
028 104 340	D.300x300	PZ	1	87,50



Tirafumi Inox Aisi 304
Monoparete
Senza Guarnizione

CODICE	MISURA	UM	PZ	€
028 104 341	D.200	PZ	1	77,30
028 104 342	D.250	PZ	1	83,50
028 104 343	D.300	PZ	1	88,20



Terminale per Stufe Pellet
Inox Aisi 304 Monoparete

CODICE	MISURA	UM	PZ	€
028 104 294	D.80	PZ	1	33,90



Cappello 4 Venti Base
Tonda Acciaio Inox Aisi304
Monoparete
Senza Guarnizione

CODICE	MISURA	UM	PZ	€
028 104 345	D.80	PZ	1	32,10
028 104 346	D.100	PZ	1	34,70
028 104 347	D.120	PZ	1	37,20
028 104 348	D.130	PZ	1	37,90
028 104 349	D.140	PZ	1	50,70
028 104 350	D.150	PZ	1	47,60
028 104 351	D.160	PZ	1	48,50
028 104 352	D.180	PZ	1	59,40
028 104 353	D.200	PZ	1	63,60
028 104 354	D.250	PZ	1	68,10
028 104 355	D.300	PZ	1	83,20



CODICE	MISURA	UM	PZ	€
028 104 360	D.170x170	PZ	1	65,40
028 104 361	D.200x200	PZ	1	65,20
028 104 362	D.220x220	PZ	1	67,10
028 104 363	D.250x250	PZ	1	69,50
028 104 364	D.270x270	PZ	1	77,20
028 104 365	D.300x300	PZ	1	75,00

Cappello Cinese Base
Quadra Acciaio Inox Aisi304
Monoparete
Senza Guarnizione



CODICE	MISURA	UM	PZ	€
028 104 490	D.80	pz	1	31,30
028 104 491	D.100	PZ	1	59,00
028 104 492	D.120	PZ	1	33,50
028 104 493	D.130	PZ	1	34,10
028 104 494	D.140	PZ	1	42,10
028 104 495	D.150	PZ	1	42,90
028 104 496	D.160	PZ	1	43,60
028 104 497	D.180	PZ	1	70,00
028 104 498	D.200	PZ	1	57,30
028 104 499	D.250	PZ	1	78,10
028 104 500	D.300	PZ	1	83,30

Cappello Cinese Antivento
Antipioggia
Acciaio Inox Aisi 304
Monoparete
Senza Guarnizione



CODICE	MISURA	UM	PZ	€
028 104 505	D.80	PZ	1	63,40
028 104 506	D.100	PZ	1	66,10
028 104 507	D.120	PZ	1	68,80
028 104 508	D.130	PZ	1	68,80
028 104 509	D.140	PZ	1	70,80
028 104 510	D.150	PZ	1	72,10
028 104 511	D.160	PZ	1	78,70

Esalatore per Caldaia Gas
Acciaio Inox Aisi 304
Monoparete
Senza Guarnizione



CODICE	MISURA	UM	PZ	€
028 104 371	D.100	PZ	1	87,70
028 104 372	D.120	PZ	1	88,50
028 104 373	D.130	PZ	1	82,90
028 104 374	D.140	PZ	1	90,70
028 104 375	D.150	PZ	1	84,90
028 104 376	D.160	PZ	1	99,90
028 104 377	D.180	PZ	1	115,50
028 104 378	D.200	PZ	1	113,40
028 104 379	D.250	PZ	1	144,40
028 104 380	D.300	PZ	1	164,40

Tubo Ispezione Con Camera
Raccolta Combustibile
Acciaio Inox Aisi 304



CODICE	MISURA	UM	PZ	€
028 104 515	D.80	PZ	1	33,60
028 104 516	D.100	PZ	1	30,00
028 104 517	D.120	PZ	1	31,20
028 104 518	D.130	PZ	1	41,30
028 104 519	D.140	PZ	1	35,20
028 104 520	D.150	PZ	1	43,80
028 104 521	D.160	PZ	1	39,10
028 104 522	D.180	PZ	1	48,40
028 104 523	D.200	PZ	1	49,20
028 104 524	D.250	PZ	1	56,60
028 104 525	D.300	PZ	1	63,90

Angolari di Supporto
Acciaio Inox Aisi 304

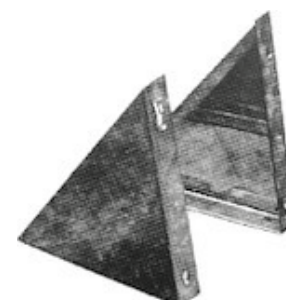



Gomito Eccentrico Regolabile
Acciaio Inox Aisi 304
Monoparete
Senza Guarnizione

CODICE	MISURA	UM	PZ	€
028 104 385	D.80	PZ	1	46,60
028 104 386	D.100	PZ	1	38,20
028 104 387	D.120	PZ	1	39,50
028 104 388	D.130	PZ	1	41,80
028 104 389	D.140	PZ	1	47,20
028 104 390	D.150	PZ	1	60,10
028 104 391	D.160	PZ	1	53,10
028 104 392	D.180	PZ	1	57,00
028 104 393	D.200	PZ	1	64,30
028 104 394	D.250	PZ	1	109,70
028 104 395	D.300	PZ	1	85,30



Giunzione
Femmina Femmina
Acciaio Inox Aisi 304
Monoparete
Senza Guarnizione

CODICE	MISURA	UM	PZ	€
028 104 415	D.80	PZ	1	5,90
028 104 416	D.100	PZ	1	7,40
028 104 417	D.120	PZ	1	8,10
028 104 418	D.130	PZ	1	8,80
028 104 419	D.140	PZ	1	9,30
028 104 420	D.150	PZ	1	9,40
028 104 421	D.160	PZ	1	10,30
028 104 422	D.180	PZ	1	10,70
028 104 423	D.200	PZ	1	11,20
028 104 424	D.250	PZ	1	13,70
028 104 425	D.300	PZ	1	18,60



Giunzione
Maschio Maschio Acciaio
Inox Aisi 304
Monoparete
Senza Guarnizione

CODICE	MISURA	UM	PZ	€
028 104 430	D.80	PZ	1	5,90
028 104 431	D.100	PZ	1	7,40
028 104 432	D.120	PZ	1	8,10
028 104 433	D.130	PZ	1	9,90
028 104 434	D.140	PZ	1	10,50
028 104 435	D.150	PZ	1	9,40
028 104 436	D.160	PZ	1	10,30
028 104 437	D.180	PZ	1	12,10
028 104 438	D.200	PZ	1	11,20
028 104 439	D.250	PZ	1	13,70
028 104 440	D.300	PZ	1	18,60



Derivazione Tee a 90°
Ridotta Acciaio Inox Aisi 304
Monoparete
Senza Guarnizione

CODICE	MISURA	UM	PZ	€
028 104 475	D.80	PZ	1	31,80
028 104 476	D.100	PZ	1	44,00
028 104 477	D.120	PZ	1	42,80
028 104 478	D.130	PZ	1	52,30
028 104 479	D.140	PZ	1	53,40
028 104 480	D.150	PZ	1	54,60
028 104 481	D.160	PZ	1	55,80
028 104 482	D.180	PZ	1	67,20
028 104 483	D.200	PZ	1	74,00
028 104 484	D.250	PZ	1	98,80
028 104 485	D.300	PZ	1	113,20

SETTORE 028
RISCALDAMENTO



CODICE	MISURA	UM	PZ	€
028 104 530	D.80	PZ	1	6,20
028 104 531	D.100	PZ	1	6,70
028 104 532	D.120	PZ	1	7,00
028 104 533	D.130	PZ	1	7,30
028 104 534	D.140	PZ	1	7,70
028 104 535	D.150	PZ	1	8,10
028 104 536	D.160	PZ	1	8,60
028 104 537	D.180	PZ	1	8,90
028 104 538	D.200	PZ	1	10,10
028 104 539	D.250	PZ	1	10,90
028 104 540	D.300	PZ	1	13,10

Collare Tondo
Acciaio Inox Aisi 304



CODICE	MISURA	UM	PZ	€
028 104 545	D. 80	PZ	1	18,80
028 104 546	D.100	PZ	1	20,80
028 104 547	D.120	PZ	1	20,30
028 104 548	D.130	PZ	1	22,70
028 104 549	D.140	PZ	1	22,90
028 104 550	D.150	PZ	1	21,50
028 104 551	D.160	PZ	1	24,60
028 104 552	D.180	PZ	1	25,60
028 104 553	D.200	PZ	1	24,20
028 104 554	D.250	PZ	1	30,20
028 104 555	D.300	PZ	1	47,20

Collare Tondo
con Staffa a Muro Omega
Acciaio Inox Aisi 304



CODICE	MISURA	UM	PZ	€
028 104 560	D.80	PZ	1	5,00
028 104 561	D.100	PZ	1	5,10
028 104 562	D.120	PZ	1	5,30
028 104 563	D.130	PZ	1	5,40
028 104 564	D.140	PZ	1	5,50
028 104 565	D.150	PZ	1	5,60
028 104 566	D.160	PZ	1	5,80
028 104 567	D.180	PZ	1	6,20
028 104 568	D.200	PZ	1	6,40
028 104 569	D.250	PZ	1	6,90
028 104 570	D.300	PZ	1	7,60

Fascetta di Bloccaggio
Acciaio Inox Aisi 304



CODICE	MISURA	UM	PZ	€
028 104 575	D. 80	PZ	1	1,50
028 104 576	D.100	PZ	1	2,10
028 104 577	D.120	PZ	1	2,30
028 104 578	D.130	PZ	1	2,50
028 104 579	D.140	PZ	1	2,60
028 104 580	D.150	PZ	1	3,10
028 104 581	D.160	PZ	1	3,70
028 104 582	D.180	PZ	1	4,30
028 104 583	D.200	PZ	1	5,10
028 104 584	D.250	PZ	1	8,70
028 104 585	D.300	PZ	1	10,10

Guarnizione Siliconata
Alta Temperatura Acciaio
Inox Aisi 304





Rosone Colore Nero
per Stufe a Pellet

CODICE	MISURA	UM	PZ	€
028 110 017	Sp.12/10 D.80 Conf. 2 Pz	PZ	2	12,60



Fascette Sorreggi Tubo
Colore Nero per Stufe a Pellet

CODICE	MISURA	UM	PZ	€
028 110 018	Sp.12/10 D.80 Conf. 2 Pz	CF	2	8,10



Tubo Pesante Colore Nero
per Stufe a Pellet

CODICE	MISURA	UM	PZ	€
028 110 001	Sp.12/10 D.80x1000 Conf. 2 Pz	CF	2	95,00
028 110 002	Sp.12/10 D.80x500 Conf. 2 Pz	CF	2	65,50
028 110 003	Sp.12/10 D.80x250 Conf. 2 Pz	CF	2	49,50



Gomito 45° Pesante
Colore Nero per Stufe a Pellet

CODICE	MISURA	UM	PZ	€
028 110 010	Sp.12/10 D.80 Conf.2 Pz	CF	2	82,50



Gomito 90° Pesante
Colore Nero per Stufe a Pellet

CODICE	MISURA	UM	PZ	€
028110011	Sp.12/10 Gomito 90° Conf. 2 Pz	CF	2	90,50



Tee Con Tappo MF
Pes.Colore Nero per Stufe
a Pellet

CODICE	MISURA	UM	PZ	€
028 110 015	Sp.12/10 D.80 Conf.2 Pz	CF	2	68,70



Tee Con Tappo MF Pesante
Colore Nero per Stufe a Pellet

CODICE	MISURA	UM	PZ	€
028 110 019	Sp.12/10 D.80 Conf.2 Pz	CF	2	68,70



Giunzione FF Pesante
Colore Nero per Stufe a Pellet

CODICE	MISURA	UM	PZ	€
028 110 016	Sp.12/10 D.80 Conf.2 Pz	CF	2	53,20



CONDIZIONAMENTO



RITE.SA Riscaldamento Termo Sanitari

Tel.: +39 0962 82473 - Fax.: +39 0962 82388  : <http://www.ritesa.it> -  : info@ritesa.it



RADIATORI A GAS



Radiatore Gas Metano
Gazelle Tirag. Forzato
Con Kit Fumi

CODICE	MISURA	UM	PZ	€
012 019 001	Modello Classico Kw2,8 3000Wat	PZ	1	1.530,50
012 019 002	Modello Classico Kw4,6 5000Wat	PZ	1	1.699,60
012 019 003	Modello Classico Kw6,15 7000Wat	PZ	1	1.766,60



Radiatore Gas Gpl Gazelle
Tiraggio Forzato
Con Kit Fumi

CODICE	MISURA	UM	PZ	€
012 019 020	Modello Classico Kw2,8 3000Wat	PZ	1	1.530,50
012 019 021	Modello Classico Kw4,6 5000Wat	PZ	1	1.611,00
012 019 022	Modello Classico Kw6,15 7000Wat	PZ	1	1.674,50

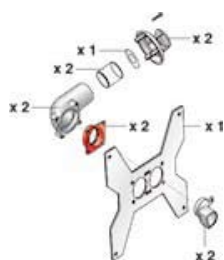

Kit Sdoppiaggio Tubazioni
per Gazella Con Staffa
di Montaggio

CODICE	MISURA	UM	PZ	€
012 019 040	D.35 mm C/staffa di Montaggio	PZ	1	80,40



Tubo Bicchierato per Gazzella
Maschio Femmina

CODICE	MISURA	UM	PZ	€
012 019 041	D.35 mm x 1 mt	PZ	1	30,90



Gomito 90° per Gazzella
Maschio Femmina

CODICE	MISURA	UM	PZ	€
012 019 042	D.35	PZ	1	23,50

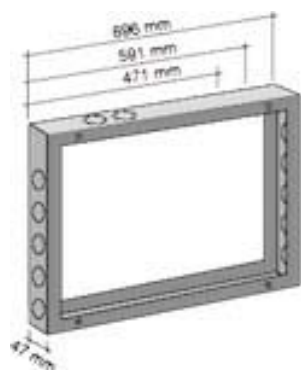

Controtelaio Distanziatore
Parete

CODICE	MISURA	UM	PZ	€
012 019 050	Mod.Classico/Primex3000 D.47x471mm	PZ	1	131,80
012 019 051	Mod.Classico/Primex5000 D.47x591mm	PZ	1	154,30
012 019 052	Mod.Classico/Primex7000 D.47x696mm	PZ	1	159,80

SETTORE 012

CONDIZIONAMENTO



CODICE	MISURA	UM	PZ	€
012 139 001	Pompa di Calore Inverter Monobl. Lite Aria/Acqua Risc.Raffr. 50M LINK	PZ	1	6.655,10
012 139 002	Pompa di Calore Inverter Monobl. Lite Aria/Acqua Risc.Raffr. 70M LINK	PZ	1	7.627,70
012 139 005	Pompa di Calore Inverter Monobl. Lite Aria/Acqua Risc.Raffr. 70M-T LINK	PZ	1	9.216,00
012 139 006	Pompa di Calore Inverter Monobl. Lite Aria/Acqua Risc.Raffr. 90M-T LINK	PZ	1	11.018,00
012 139 007	Pompa di Calore Inverter Monobl. Lite Aria/Acqua Risc.Raf. 120M-T LINK	PZ	1	11.3158,30

Pompa di Calore Inverter Monobl. Lite Aria/Acqua Riscaldamento e Raffrescamento

CODICE	MISURA	UM	PZ	€
012 139 030	Accumolo Inerziale Install. Sotto Unità Esterna Riscal. Raffr. CKZ 30HH	PZ	1	1.506,10
012 139 031	Accumolo Inerziale Install. Sotto Unità Esterna Riscal. Raffr. CKZ 50HH	PZ	1	1.641,30

Accumolo Inerziale Install. Sotto Unità Esterna Riscaldamento e Raffrescamento

CODICE	MISURA	UM	PZ	€
012 139 015	Pompa di Calore Inver. Monobl. Flex San. Aria/Acqua Risc. Raff. 50M LINK	PZ	1	10.359,70
012 139 016	Pompa di Calore Inver. Monobl. Flex San. Aria/Acqua Risc. Raff. 70M LINK	PZ	1	12.784,10
012 139 017	Pompa di Calore Inver. Monobl. Flex San. Aria/Acqua Risc. Raf. 70M-T LINK	PZ	1	13.277,00
012 139 018	Pompa di Calore Inver. Monobl. Flex San. Aria/Acqua Risc. Raf. 90M-T LINK	PZ	1	14.926,00
012 139 019	Pompa di Calore Inver. Monobl. Flex San. Aria/Acqua Risc. Raf. 90M-T LINK	PZ	1	17.151,50
012 139 020	Pompa di Calore Inver. Monobl. Flex San. Aria/Acqua Risc. Raf. 110M-T LINK	PZ	1	15.361,30
012 139 021	Pompa di Calore Inver. Monobl. Flex San. Aria/Acqua Risc. Raf. 300M-T LINK	PZ	1	15.746,70

Pompa di Calore Inverter Monoblocco Flex Sanitaria Aria/Acqua Riscaldamento



Ventilconvettore Fan-Coil
a Parete con Aspirazione
Inferiore



CODICE	MISURA	UM	PZ	€
012 177 005	Yardy 15 Raffrescamento Kw 1,07 Riscaldamento Kw 1,48	PZ	1	446,60
012 177 006	Yardy 24 Raffrescamento Kw 2,24 Riscaldamento Kw 2,78	PZ	1	495,10
012 177 007	Yardy 30 Raffrescamento Kw 2,85 Riscaldamento Kw 3,85	PZ	1	565,00
012 177 039	Yardy 48 Raffrescamento Kw 4,64 Riscaldamento Kw 5,54 120x57x22	PZ	1	684,20

Chillers Rhoss Con Pompa
Colore e Kit Tdruatico



CODICE	MISURA	UM	PZ	€
012 177 080	Rhoss 105 C/Pompa Colore Kit Pot.Frig.5,20KwPot.term.6,40Kw	PZ	1	8641,20
012 177 081	Rhoss 110 C/Pompa Colore Kit Pot.Frig.9,00KwPot.term.9,80Kw	PZ	1	9145,00
012 177 082	Rhoss 116 C/Pompa Colore Kit Pot.Frig.16,0KwPot.term.16,7Kw	PZ	1	12919,10

Comando Rhoss Estate/In-
verno con Sonda di Minima
KTA+KTM



CODICE	MISURA	UM	PZ	€
012 177 010	Sonda di Minima KTA+KTM	PZ	1	78,30
012 177 011	Sonda di Minima KM	PZ	1	25,60
012 177 012	Comando KTA	PZ	1	52,80

Accessori per Chillers Kit
Antivibrante



CODICE	MISURA	UM	PZ	€
012 177 090	Rhoss 7378 Kg 50 56x20	PZ	1	16,30
012 177 091	Kit Tastiera Remota Rhoss KTR	PZ	1	363,70
012 177 095	Accumolo Inerziale Rhoss HPA 30AI	PZ	1	1449,40



CODICE	MISURA	UM	PZ	€
012 188 001	SL200C L 735mm H 579mm P129 Raffred. 0,83 Kw Riscald.1,09Kw Δt 50	PZ	1	696,60
012 188 002	SL400C L 935mm H 579mm P129 Raffred.1,76Kw Riscald.2,35Kw Δt 50	PZ	1	771,20
012 188 003	SL600C L 1135mm H 579mm P129 Raffred.2,65Kw Riscald.3,19Kw Δt 50	PZ	1	903,90
012 188 004	SL800C L 1335mm H 579mm P129 Raffred.3,34w Riscald.4,10Kw Δt 50	PZ	1	1.078,10
012 188 010	Comando elettronico di controllo Innova ECA644III Smart Touch	PZ	1	265,40
012 188 011	Comando elettronico di controllo Innova E2T543III	PZ	1	141,00
012 188 015	Elettrovalvola 3Vie per impianti due tubi Innova V3036III	PZ	1	248,80

Ventilconvettore Fan-Coil
Slim DC Inverter
con Aspirazione Inferiore
Innova



CODICE	MISURA	UM	PZ	€
012 177 040	Rhoss Mic 20 Rafr.2,01 Kw Risc.3,6Kw Δt 50	PZ	1	1207,00
012 177 041	Rhoss Mic 30 Rafr.2,98Kw Risc.4,78Kw Δt 50	PZ	1	1270,50
012 177 042	Rhoss Mic 40 Rafr.3,54Kw Risc.5,14Kw Δt 50	PZ	1	1414,40

Ventilconvettore Fan-Coil
Split Parete Rhoss 20
Con elettrov.e Telecomando





Canalina per Clima PVC
Bianca

CODICE	MISURA	UM	PZ	€
012 015 001	Lunghezza 2 mt x H50 mm x P65 mm	ML	2	7,10
012 015 002	Lunghezza 2 mt x H65 mm x P90 mm	ML	2	9,90



Supporto Bloccaggio
per Canalina per Clima PVC
Bianca

CODICE	MISURA	UM	PZ	€
012 015 005	H50mmxP65mm	PZ	1	0,60
012 015 006	H65mmxP90mm	PZ	1	0,70



Giunto Coperchio Aggancio
Base per Canalina per Clima
PVC Bianca

CODICE	MISURA	UM	PZ	€
012 015 010	H50mmxP65mm	PZ	1	2,60
012 015 011	H65mmxP90mm	PZ	1	3,20



Passaggio Muro Aggancio
Base per Canalina per Clima
PVC Bianca

CODICE	MISURA	UM	PZ	€
012 015 015	H50mmxP65mm	PZ	1	4,50
012 015 016	H65mmxP90mm	PZ	1	5,20



Angolo Interno Aggancio
Base per Canalina per Clima
PVC Bianca

CODICE	MISURA	UM	PZ	€
012 015 020	H50mmxP65mm	PZ	1	5,20
012 015 021	H65mmxP90mm	PZ	1	6,40



Angolo Esterno Aggancio
Base per Canalina per Clima
PVC Bianca

CODICE	MISURA	UM	PZ	€
012 015 025	H50mmxP65mm	PZ	1	5,20
012 015 026	H65mmxP90mm	PZ	1	6,40



Curva Piana Aggancio Base
per Canalina per Clima PVC
Bianca

CODICE	MISURA	UM	PZ	€
012 015 030	H50mmxP65mm	PZ	1	5,40
012 015 031	H65mmxP90mm	PZ	1	7,30



Curva a Muro Base
per Canalina per Clima PVC
Bianca

CODICE	MISURA	UM	PZ	€
012 015 040	Curva a Muro Base per Canalina per Clima PVC Bianca H50mmx-P65mm	PZ	1	6,30
012 015 041	Curva a Muro Base per Canalina per Clima PVC Bianca H65mmx-P90mm	PZ	1	7,50



Curva a Muro Senza Base
Canalina per Clima PVC
Bianca

CODICE	MISURA	UM	PZ	€
012 015 035	Curva a Muro Senza Base Canalina per Clima PVC Bianca H50mmxP65mm	PZ	1	4,70
012 015 036	Curva a Muro Senza Base Canalina per Clima PVC Bianca H65mmxP90mm	PZ	1	6,40



Curva Regolabile da 45°
a 135° Snodabile Canalina
Clima

CODICE	MISURA	UM	PZ	€
012 015 045	Curva Regolabile da 45° a 135° Snodabile Canalina Clima H50mmxP65mm	PZ	1	13,90



CODICE	MISURA	UM	PZ	€
012 015 050	H65mmxP90mm	PZ	1	37,20

Giunto Flessibile Base
Canalina Clima PVC
Bianca



CODICE	MISURA	UM	PZ	€
012 015 055	H50mmxP65mm	PZ	1	3,70
012 015 056	H65mmxP90mm	PZ	1	4,60

Guarnizione Giunto Coperchio
Base Canalina Clima PVC
Bianca



CODICE	MISURA	UM	PZ	€
012 015 060	H65mmxP90mm	PZ	1	10,80

Derivazione Aggancio Base
per Canalina Clima PVC
Bianca



CODICE	MISURA	UM	PZ	€
012 015 065	H65mmxP90mm	PZ	1	5,90

Riduzione Aggancio Base
per Canalina Clima PVC
Bianca



CODICE	MISURA	UM	PZ	€
012 022 001	D.140 Int. 80/125	PZ	1	3,70
012 022 002	D.175 Int.125/160	PZ	1	5,70
012 022 003	D.220 Int.160/200	PZ	1	7,30

Griglia di Aerazione
Tonda con Mola



CODICE	MISURA	UM	PZ	€
023 025 013	R32 Gr 800 lt 1 UN 3163	PZ	1	65,60

Bombolette ricaricabili
Gas Refrigerante R32



CODICE	MISURA	UM	PZ	€
023 025 010	R422D Gr 900	PZ	1	138,20
023 025 020	R422D lt 2,5	PZ	1	133,40

Bombolette ricaricabili
Gas Refrigerante R422D



CODICE	MISURA	UM	PZ	€
023 025 011	R410A Gr 800	PZ	1	79,30
023 025 021	R410A lt 2,5	PZ	1	77,20

Bombolette ricaricabili Gas
Refrigerante R410A



CODICE	MISURA	UM	PZ	€
023 025 012	R407C Gr 850	PZ	1	104,30
023 025 022	R407C lt 2,5	PZ	1	77,20

Bombolette ricaricabili Gas
Refrigerante R407C



CODICE	MISURA	UM	PZ	€
023 025 015	Gr 800 lt 1 ACUNI	PZ	1	34,10

Bombolette ricaricabili Azoto



CODICE	MISURA	UM	PZ	€
023 025 001	35 Lt/Min per R407C-R410A	PZ	1	2450,60
023 025 002	65 Lt/Min per R407C-R410A	PZ	1	2641,70

Centralina Vuoto/Carica
Completa





Raccordo Doppio per Tubo Rame Gas Clima

CODICE	MISURA	UM	PZ	€
019 018 085	D.1/4 x6x1/4	PZ	10	3,40
019 018 086	D.3/8x10x3/8	PZ	10	5,50
019 018 087	D.1/2x12x1/2	PZ	10	7,60
019 018 088	D.5/8x16x5/8	PZ	10	4,40



Raccordo Autocartellante per Tubo Rame Gas Clima

CODICE	MISURA	UM	PZ	€
012 015 100	D.1/4 x6	PZ	10	9,20
012 015 101	D.3/8x10	PZ	10	10,30



Raccordo Calotta Ottone Giallo per Tubo Rame Gas Clima

CODICE	MISURA	UM	PZ	€
012 015 120	D.1/4	PZ	10	1,00
012 015 121	D.3/8	PZ	10	1,60
012 015 122	D.1/2	PZ	10	2,20
012 015 123	D.5/8	PZ	10	2,20



Raccordo Calotta Ridotta Ottone per Tubo Rame Gas Clima

CODICE	MISURA	UM	PZ	€
012 015 130	D.1/4x3/8	PZ	10	1,50
012 015 131	D.3/8x1/2	PZ	10	2,30
012 015 132	D.1/2x5/8	PZ	10	4,30



Raccordo Nipple Doppio Ottone Giallo per Tubo Rame Gas Clima

CODICE	MISURA	UM	PZ	€
012 015 140	D.1/4	PZ	10	1,30
012 015 141	D.3/8	PZ	10	2,10
012 015 142	D.1/2	PZ	10	3,30
012 015 143	D.5/8	PZ	10	4,70



Raccordo Nipple Ridotto Ottone per Tubo Rame Gas Clima

CODICE	MISURA	UM	PZ	€
012 015 150	D.1/4x3/8	PZ	10	3,90
012 015 151	D.3/8x1/2	PZ	10	4,40
012 015 152	D.1/2x5/8	PZ	10	6,50



Raccordo Prolunga Ridotta Ottone per Tubo Rame Gas Clima

CODICE	MISURA	UM	PZ	€
012 015 160	D.3/8Fx1/4M	PZ	10	4,10
012 015 161	D.1/2Fx1/4M	PZ	10	3,90
012 015 162	D.1/2Fx3/8M	PZ	10	4,60
012 015 163	D.3/8Fx1/2M	PZ	10	2,50



Raccordo Inversione Unità Interna Auto Cartellante per Tubo Clima

CODICE	MISURA	UM	PZ	€
012 015 105	D.1/4	PZ	10	15,60
012 015 106	D.3/8	PZ	10	20,80



CODICE	MISURA	UM	PZ	€
003 168 004	Grigio D. 16	ML	25	1,40
003 168 009	Grigio D. 18	ML	25	1,70
003 168 005	Grigio D. 20	ML	25	1,30

Tubo Guaina Spirolato Pvc per Condensa



CODICE	MISURA	UM	PZ	€
012 015 095	D.16 Bianco Pvc	PZ	1	3,10
012 015 096	D.18 Bianco Pvc	PZ	1	3,20
012 015 097	D.20 Bianco Pvc	PZ	1	3,80

Raccordo Diritto per Tubo Spirolato Condensa Clima



CODICE	MISURA	UM	PZ	€
012 015 090	D.16 Bianco Pvc	PZ	10	5,00
012 015 091	D.18 Bianco Pvc	PZ	10	5,10
012 015 092	D.20 Bianco Pvc	PZ	10	6,10

Raccordo a Y per Tubo Spirolato Condensa Clima



CODICE	MISURA	UM	PZ	€
012 015 085	D.16 Bianco Pvc	PZ	10	5,10
012 015 086	D.18 Bianco Pvc	PZ	10	5,70
012 015 087	D.20 Bianco Pvc	PZ	10	6,10

Raccordo a Tee per Tubo Spirolato Condensa Clima



CODICE	MISURA	UM	PZ	€
012 015 076	D.16-18-20	PZ	1	2,30

Raccordo 90° Predisposizione Cassetta Clima Condensa



CODICE	MISURA	UM	PZ	€
012 015 070	D.16-18 B/co Pvc	PZ	1	2,80
012 015 071	D.18-20 B/co Pvc	PZ	1	2,90

Raccordo a Y 3Vie per Tubo Spirolato Condensa Clima



CODICE	MISURA	UM	PZ	€
012 015 074	D.16-18 B/co Pvc	PZ	1	3,10
012 015 075	D.18-20 B/co Pvc	PZ	1	3,20

Raccordo Spostato per Tubo Spirolato Condensa Clima



CODICE	MISURA	UM	PZ	€
012 015 072	D.16-18 Bianco Pvc	PZ	1	3,90
012 015 073	D.18-20 Bianco Pvc	PZ	1	4,30

Raccordo a Tee per Tubo Spirolato Condensa Clima





Aspiratore Elettrico

CODICE	MISURA	UM	PZ	€
012 015 110	D.99-100 mt3/h 19 Wat	PZ	1	39,40



Pompa Condensa Klima
Minipompa Siccom

CODICE	MISURA	UM	PZ	€
012 015 115	Mod.Flowwatch Tecnogas 11903	PZ	1	205,10



Guaina Biestrusa Sotto
Traccia per Condensa Klima

CODICE	MISURA	UM	PZ	€
012 015 080	D.16-18 Bianco Pvc	ML	50	1,40
012 015 081	D.18-20 Bianco Pvc	ML	50	1,50



Cassetta Predisposizione
per Condensa Klima

CODICE	MISURA	UM	PZ	€
023 022 001	Cassetta Predisposizione per- Condensa Klima L430xH100xP60 mm	PZ	1	18,10

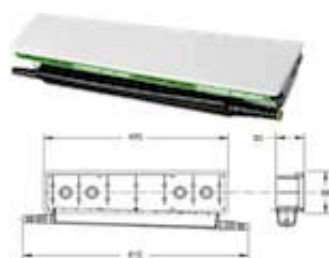

Cassetta Coibentata
Predisposizione Condensa
Klima Bonomini

CODICE	MISURA	UM	PZ	€
023 022 002	L420xH98xP60 mm	PZ	1	22,20



Sifone a Secco Bonomini
per Scarico Condensa

CODICE	MISURA	UM	PZ	€
023 022 005	D.32	PZ	1	12,50



CODICE	MISURA	UM	PZ	€
023 185 001	9000 Btu Monosplit Inv.HTG-09IV+HTN-09IV	PZ	1	1.016,90
023 185 002	12000Btu Monosplit Inv.HTG-12IV+HTN-12IV	PZ	1	1.127,20
023 185 003	17000Btu Monosplit Inv.HTG-17IV+HTN-17IV	PZ	1	
023 185 004	21000Btu Monosplit Inv.HTG-21IV+HTN-21IV	PZ	1	

Climatizzatore Toyotomi Hiro



CODICE	MISURA	UM	PZ	€
023 185 010	9000 Btu Monoplit TRG-5287R+TRN-528ZR	PZ	1	1165,60
023 185 011	12000 Btu Monoplit TRG-5357R+TRN-535ZR	PZ	1	1266,30
023 185 012	18000 Btu Monoplit TRG-5567R+TRN-556ZR	PZ	1	2019,40
023 185 013	24000 Btu Monoplit TRG-5717R+TRN-571ZR	PZ	1	2494,20

Climatizzatore Toyotomi
IZURU





Climatizzatore Toyotomi
Multisplit
Unità Esterna



CODICE	MISURA	UM	PZ	€
023 185 020	14000 Btu Multisplit 2 At.Un.Est.MFM 14 INV-2	PZ	1	
023 185 022	21000 Btu Multisplit 3 At.Un.Est.MFM 21 INV-3	PZ	1	
023 185 023	24000 Btu Multisplit 3 At.Un.Est.MFM 24 INV-3	PZ	1	

Climatizzatore Toyotomi
Multiplit Izuru
Unità Interna



CODICE	MISURA	UM	PZ	€
023 185 030	9000 Btu Multisplit Izuru Unità Interna RN-522ZR	PZ	1	
023 185 031	12000 Btu Multisplit Izuru Unità Interna TRN-528ZR	PZ	1	

Barriera D'Aria
Toyotomi Air Curtains



CODICE	MISURA	UM	PZ	€
023 185 040	Mod. Curt 900 mm 870x160	PZ	1	
023 185 041	Mod. Curt 1200 mm 1170x160	PZ	1	



CODICE	MISURA	UM	PZ	€
023 183 001	Climatizzatore Toshiba Avant10000 Ras107sav-E6+107Skv-E7	PZ	1	1490,80
023 183 002	Climatizzatore Toshiba Avant13000 Ras13Bvg-E+13Bkvg-e Mirai R32	PZ	1	1683,30
023 183 003	Climatizzatore Toshiba Avant16000 Ras16Bvg-E+16Bkvg-e Mirai R32	PZ	1	2547,10

Climatizzatore Toshiba Avant



CODICE	MISURA	UM	PZ	€
023 183 010	Climatizzatore Toshiba Unità Esterna 2 Att.C/Pompa Ras-2-m1853Av-E	PZ	1	3157,60
023 183 011	Climatizzatore Toshiba Unità Esterna 3 Att.C/Pompa Ras-3-m2653Av-E	PZ	1	4899,10
023 183 020	Climatizzatore Toshiba Unità Interna Multi 10000 Btu Ras-B10n3Kv2-E1	PZ	1	985,60
023 183 021	Climatizzatore Toshiba Unità Interna Multi 13000 Btu Ras-B13n3Kv2-E1	PZ	1	1119,50

Climatizzatore Toshiba Multisplit
Unità Esterna e Interna da Combinare





**Climatizzatore
Midea Blanc**



CODICE	MISURA	UM	PZ	€
023 184 001	Climatizzatore Midea Blanc 27 9000 Btu Monosplit Inverter 2.7 kw	PZ	1	1.080,20
023 184 002	Climatizzatore Midea Blanc 35 12000 Btu Monosplit Inverter 3.5 kw	PZ	1	1.214,70
023 184 003	Climatizzatore Midea Blanc 53 18000 Btu Monosplit Inverter 5.3 kw	PZ	1	1.869,90

**Climatizzatore
Midea Mission Monosplit**



CODICE	MISURA	UM	PZ	€
023 184 010	Climatizzatore Midea MissionWH 27 9000 Btu Monosplit Inverter 2.7kw	PZ	1	1.224,50
023 184 011	Climatizzatore Midea MissionWH 35 12000 Btu Monosplit Inverter 3.5kw	PZ	1	1.368,50
023 184 012	Climatizzatore Midea MissionWF 53 18000 Btu Monosplit Inverter 5.3kw	PZ	1	2.112,50
023 184 013	Climatizzatore Midea MissionWF 70 24000 Btu Monosplit Inverter 7.0kw	PZ	1	2.592,50

**Climatizzatore
Midea Mission Dualsplit**



CODICE	MISURA	UM	PZ	€
023 184 020	Climatizzatore Midea Mission 2N-41K 9+9 Btu Dualsplit Inverter 4.0kw	PZ	1	2760,70
023 184 021	Climatizzatore Midea Mission 2N-53K 9+12 Btu Dualsplit Invert.5,4kw	PZ	1	3348,30
023 184 023	Climatizzatore Midea Mission 2N-53K 12+12 Btu Dualsplit Invert.5,4kw	PZ	1	3424,10



ECOENERGIA



RITE.SA Riscaldamento Termo Sanitari

Tel.: +39 0962 82473 - Fax.: +39 0962 82388  : <http://www.ritesa.it> -  : info@ritesa.it



Termocamino Produzione
AcquaCalda Sanitaria
e Riscaldamento

CODICE	MISURA	UM	PZ	€
022 043 002	Termocamino Produzione AcquaCalda Sanitaria e Riscaldamento Kcal 29	PZ	1	4428,30
022 043 003	Termocamino Produzione AcquaCalda Sanitaria e Riscaldamento Kcal 25	PZ	1	4208,90



Termocamino Produzione
AcquaCalda Sanitaria
e Riscaldamento

CODICE	MISURA	UM	PZ	€
022 043 001	Termocamino Produzione AcquaCalda Sanitaria e Riscaldamento Kcal 19	PZ	1	3526,40



Termocamino Vulcano
Produzione Acqua Calda
Sanitaria e Riscaldamento

CODICE	MISURA	UM	PZ	€
022 043 005	Termocamino Vulcano Produzione Acqua Calda Sanitaria e Risc. Kcal 25	PZ	1	7689,20



Stufa ad Aria a Legna
Albicocca EdilKamin

CODICE	MISURA	UM	PZ	€
022 045 021	Stufa ad Aria a Legna Albicocca EdilKamin Kw 7,8 L60xH94xP48 Cm	PZ	1	2710,60



CODICE	MISURA	UM	PZ	€
022 045 028	Kw 11,3	PZ	1	3.989,50

Stufa Idro a Pellet Italiana
 Camini Idro Point Bordeaux



CODICE	MISURA	UM	PZ	€
022 045 035	Da Kw 18 a Kw 22	PZ	1	2.458,70

Stufa Idro a Pellet Italiana
 Camini Layma



CODICE	MISURA	UM	PZ	€
022 045 032	Kw 23	PZ	1	6.312,70

Stufa Idro a Pellet Italiana
 Camini Nelly Bianco Panna



CODICE	MISURA	UM	PZ	€
022 045 033	Kw 9	PZ	1	6.215,80

Stufa Pellet Aria Canalizzabile
 Italiana Camini Piro Plus



SETTORE 022

ECOENERGIE



Stufa ad Aria a Pellet Italiana
Camini Prima Bordeaux

CODICE	MISURA	UM	PZ	€
022 045 027	Kw 7	PZ	1	2.444,90



Stufa ad Aria a Pellet Italiana
Camini Prima Bianco Panna

CODICE	MISURA	UM	PZ	€
022 045 024	Kw 7	PZ	1	2.444,90



Stufa ad Aria a Pellet Italiana
Camini Ten Plus Bordeaux

CODICE	MISURA	UM	PZ	€
022 045 022	Kw 10	PZ	1	3.979,40



Stufa ad Aria a Pellet Italiana
Camini Dida Plus Bordeaux

CODICE	MISURA	UM	PZ	€
022 045 023	Kw 12	PZ	1	4.226,80



CODICE	MISURA	UM	PZ	€
022 046 001	kw 6 A.& C. L43xP47,5xH84,5 Kg 92	PZ	1	1.986,90

Stufa ad Aria Marina Eco
Bordeaux/Beige



CODICE	MISURA	UM	PZ	€
022 043 010	Kw 9	PZ	1	1.872,70

Stufa ad Aria a Pellet Italiana
Eva Stampaggi Rita
Rosso/Bianca



CODICE	MISURA	UM	PZ	€
022 045 020	Kw 8 L60xH95xP53 Cm Fino ad esaurimento scorte	PZ	1	4.180,20

Termostufa ad Aria a Pellet
Lilla Plus EdilKamin





Stufa Idro 13

CODICE	MISURA	UM	PZ	€
022 046 010	Bianco kw 13,3 A.& C. L57,5xP57,2xH102 Kg 170	PZ	1	4.214,60
022 046 011	13 Bordeaux kw 13,3 A.& C. L57,5xP57,2xH102 Kg 170	PZ	1	4.214,60



Stufa Idro 15 Beige

CODICE	MISURA	UM	PZ	€
022 046 015	Stufa Idro 15 Beige kw 15,7 A.& C. L52,5xP60xH110 Kg 190	PZ	1	5.017,40
022 046 016	Stufa Idro 15 Bordeaux kw 15,7 A.& C. L52,5xP60xH110 Kg 190	PZ	1	5.017,40



Stufa Idro 1 Beige

CODICE	MISURA	UM	PZ	€
022 046 020	Stufa Idro 1 Beige kw 19,7 A.& C. L47,2xP55,7xH120 Kg 205	PZ	1	5.418,70
022 046 021	Stufa Idro 1 Bordeaux kw 19,7 A.& C. L47,2xP55,7xH120 Kg 205	PZ	1	5.418,70



Stufa Idro 2 Beige

CODICE	MISURA	UM	PZ	€
022 046 025	Stufa Idro 2 Beige kw 24,6 A.& C. L72xP74,2xH145.5 Kg 205	PZ	1	7.225,00
022 046 026	Stufa Idro 2 Bordeaux kw 24,6 A.& C. L72xP74,2xH145.5 Kg 205	PZ	1	7.225,00



CODICE	MISURA	UM	PZ	€
029 139 012	Lt150/TR	PZ	1	2.326,70
029 139 014	Lt200/TR	PZ	1	2.576,10

Sistema Solare Naturale
Kit 1 Collettore
Telaio Terra con Bollitore



CODICE	MISURA	UM	PZ	€
029 139 016	Lt300/TR	PZ	1	3.994,60

Sistema Solare Naturale
Kit 1 Collettore
Telaio Terra con Bollitore



CODICE	MISURA	UM	PZ	€
029 139 013	Lt150/TT	PZ	1	2.251,60
029 139 015	Lt200/TT	PZ	1	2.501,10

Sistema Solare Naturale
Kit 1 Collettore
Telaio Tetto con Bollitore



CODICE	MISURA	UM	PZ	€
029 139 017	Lt300/TT	PZ	1	3.910,50
029 139 029	Lt200/TR	PZ	1	3.645,60
029 139 028	Lt200/TT	PZ	1	3.574,10

Sistema Solare Naturale
Kit 1 Collettore
Telaio Tetto con Bollitore

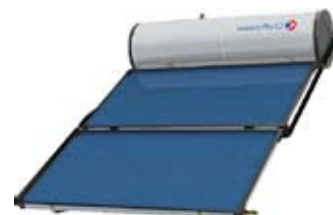



Sistema Solare Forzato
Kit 1 Collettore
Telaio Terra con Bollitore

CODICE	MISURA	UM	PZ	€
029 139 018	Lt150/TR	PZ	1	4.394,60



Sistema Solare Forzato
Kit 2 Collettore
Telaio Terra con Bollitore

CODICE	MISURA	UM	PZ	€
029 139 020	Lt200/TR	PZ	1	4.713,30
029 139 022	Lt300/TR	PZ	1	6.866,50



Sistema Solare Forzato
Kit 1 Collettore
Telaio Tetto con Bollitore

CODICE	MISURA	UM	PZ	€
029 139 019	Lt150/TT	PZ	1	4.139,80



Sistema Solare Forzato
Kit 2 Collettore
Telaio Tetto con Bollitore

CODICE	MISURA	UM	PZ	€
029 139 021	Lt200/TT	PZ	1	4.503,00
029 139 023	Lt300/TT	PZ	1	5.740,10



CODICE	MISURA	UM	PZ	€
016 139 057	Esbe 31101000 VTA322 35°-60° 1,6 Ksv	PZ	1	111,80

Miscelatore Termostatico Solare



CODICE	MISURA	UM	PZ	€
016 139 056	D.3/4 M.	PZ	1	283,10

Valvola Motorizzata Deviatrice a 3 vie per Impianto Solare



CODICE	MISURA	UM	PZ	€
016 139 055	D.	PZ	1	164,10

Valvola Miscelatrice Termostatica Meccanica per Impianto Solare



CODICE	MISURA	UM	PZ	€
029 174 001	D.16x25mt 701435010425	ML	25	45,60
029 174 002	D.16x15mt 701435010415	ML	15	45,60
029 174 003	D.20x25mt 701436010425	ML	25	56,90
029 174 004	D.20x15mt 701436010415	ML	15	56,90
029 174 008	D.25x15mt 701437010115	ML	15	71,10

Tubi Flessibili per Impianti Solari Termici



CODICE	MISURA	UM	PZ	€
016 139 050	D.1" M.45° Esbe VM322 - ESBE	PZ	1	308,80

Kit Termico Solare Deviatore e Termostatico





Liquido Glicole
per Impianti Solari

CODICE	MISURA	UM	PZ	€
004 005 002	Lt 10	PZ	1	105,20
004 005 009	Lt 5	PZ	1	54,50



Vaso Espansione
per Solare Termico

CODICE	MISURA	UM	PZ	€
002 071 057	Lt 24-8 bar	PZ	1	82,00
002 071 058	Lt 35-8 bar	PZ	1	133,70



Resistenza Elettrica
Kit Bollitori Solari Flangiato
con Anodo-Termico

CODICE	MISURA	UM	PZ	€
016 139 053	Kw1,5	PZ	1	88,50



Raccordo Dritto
Maschio per Impianti Solari
Auto Cartellante

CODICE	MISURA	UM	PZ	€
029 174 020	D.3/4x16	PZ	10	17,80
029 174 021	D.3/4x20	PZ	10	22,80
029 174 022	D.1" x25	PZ	10	41,70



Raccordo Dritto Femmina
per Impianto Solare
Autoartellante

CODICE	MISURA	UM	PZ	€
029 174 030	D.3/4x16	PZ	10	16,50
029 174 031	D.3/4x20	PZ	10	17,10
029 174 032	D.1" x25	PZ	10	29,60



Raccordo Dritto
Doppio per Impianto Solare
Autocartellante

CODICE	MISURA	UM	PZ	€
029 174 040	D.16x16	PZ	10	40,80
029 174 041	D.20x20	PZ	10	55,10
029 174 042	D.25x25	PZ	10	83,40



CODICE	MISURA	UM	PZ	€
029 139 060	Lt 200 Ext	PZ	1	4.552,80

Pompa di Calore Acquanext
per Acqua Sanitaria
Ext Chaffoteaux



CODICE	MISURA	UM	PZ	€
029 139 061	Lt 250 Ext	PZ	1	4.641,60
029 139 062	Lt 250 Sys Ext Con scambiatore solare	PZ	1	4.796,40

Pompa di Calore Acquanext
per Acqua Sanitaria
Ext Chaffoteaux



CODICE	MISURA	UM	PZ	€
029 139 065	Lt 200	PZ	1	4.450,50

Pompa di Calore Acquanext
per Acqua Sanitaria Facile
Chaffoteaux



CODICE	MISURA	UM	PZ	€
029139066	Lt 240	PZ	1	4.521,00
029139067	Lt 240 Sys Con scambiatore solare	PZ	1	4.732,30

Pompa di Calore Acquanext
per Acqua Sanitaria Facile
Chaffoteaux





Pompa Disostruente Manuale

CODICE	MISURA	UM	PZ	€
030 186 001	D.260 x 120 x 570 mm	PZ	1	307,200



Tagliatubi rame MINI

CODICE	MISURA	UM	PZ	€
030 186 005	(3-22 mm) D.3- 22 mm	PZ	1	20,100



Tagliatubi rame Special

CODICE	MISURA	UM	PZ	€
030 186 006	6- 38 mm	PZ	1	61,500



Pompa Collaudo Orizzontale

CODICE	MISURA	UM	PZ	€
030 186 015	60 Bar D.500x190x280 mm 12lt 60 bar 7,7Kg	PZ	1	348,100



Chiave Universale Pilette

CODICE	MISURA	UM	PZ	€
030 186 020	1" e 1 1/4" L160 mm	PZ	1	53,300



Curvatubi CM

CODICE	MISURA	UM	PZ	€
030 186 025	10, 12, 14, 16, 18, 20, 22 mm D.390 x 318 x 1114 mm	PZ	1	323,600

CODICE	MISURA	UM	PZ	€
030 186 030	D. 26 mm	PZ	1	28,700

Matrici Intercambiabili e utilizzabili su CM e ALPEM



CODICE	MISURA	UM	PZ	€
030 186 035	16x2-20x2-26x3-32x3	PZ	1	77,800

Calibratore



CODICE	MISURA	UM	PZ	€
030 186 040	Lung.7"/175 Apert.1"/30 mm	PZ	1	11,90
030 186 041	Lung.10"/240 Ap.1"1/4/30 mm	PZ	1	13,10
030 186 042	Lung.7"/175 Apert.1"/30 mm	PZ	1	11,10
030 186 043	Lung.10"/240 Apert.1"1/4/40 mm	PZ	1	13,10

Pinza ad Impugnatura Regolabile
Apertura da 1"/30 mm a 7"/175mm



CODICE	MISURA	UM	PZ	€
030 186 050	42L/min Attacco ai servizi 1/4"SAE	PZ	1	305,00

Pompa Vuoto Bistadio



CODICE	MISURA	UM	PZ	€
030 186 055	Kit 1/4"-1/4"45° 1500 RNK	PZ	1	102,40
030 186 056	Kit 5/16"-5/16"45° 1500 RNK	PZ	1	102,40

Tubi Colorati con Depressore e Rubinetto



CODICE	MISURA	UM	PZ	€
030 186 060	R422, R407C, R134a	PZ	1	143,40
030 186 061	Vie R410A, R32	PZ	1	143,40

Manometri pulse-free vite regolazione
Gruppo Manometro 4 Vie





Utensile Colletti Frizione

CODICE	MISURA	UM	PZ	€
030 186 065	45° FT 400 1/4"-3/4" D.260 x 120 x 570 mm	PZ	1	114,70



Detergente Sanificante
Bomboletta Spray

CODICE	MISURA	UM	PZ	€
030 186 070	ml 500	PZ	1	8,60



Bomboletta Miscela Metil
Acetilene Propadiene

CODICE	MISURA	UM	PZ	€
030 186 075	att.7/16"450g	PZ	1	26,70



Ganascia Tipo VIEGA
Sampress/Profipress
FRABO - Frabopress

CODICE	MISURA	UM	PZ	€
030 186 080	V 12	PZ	1	204,80
030 186 081	V 14	PZ	1	204,80
030 186 082	V 15	PZ	1	204,80
030 186 083	V 18	PZ	1	204,80
030 186 084	V 22	PZ	1	204,80
030 186 085	V 28	PZ	1	204,80
030 186 086	V 35	PZ	1	204,80
030 186 087	V 42	PZ	1	516,00
030 186 088	V 54	PZ	1	569,30



Ganascia Tipo Henco
Tiemme - Comap
Sudopress - Dalpex
Giacomini

CODICE	MISURA	UM	PZ	€
030 186 090	TH 16	PZ	1	204,80
030 186 091	TH 20	PZ	1	204,80
030 186 092	TH 26	PZ	1	204,80
030 186 093	TH 32	PZ	1	348,10



Forbice universale per cavi
elettrici in acciaio inox

CODICE	MISURA	UM	PZ	€
030 186 128	L.45 x 155	PZ	1	22,60

CODICE	MISURA	UM	PZ	€
030 186 095	PVC, PE, PP, PB, VPE, PVDF, MPL	PZ	1	29,70

Cesoia CLASSIC 42



CODICE	MISURA	UM	PZ	€
030 186 100	Kit Chiave Scalino + Cricco 1/2"	PZ	1	73,70

Chiave a scalino



CODICE	MISURA	UM	PZ	€
030 186 106	D.1"1/2/46 mm Lungh.16"/420 mm	PZ	1	49,20
030 186 106	D.2"/65 mm Lungh.20"/530 mm	PZ	1	77,80

Giratubi Svedese 45°



CODICE	MISURA	UM	PZ	€
030 186 110	Lunghezza 500 mm	PZ	1	24,60
030 186 111	Lunghezza 750 mm	PZ	1	20,50

Chiave Manovra Fissa per Radiatori 18 mm



CODICE	MISURA	UM	PZ	€
030 186 115	20-25-32-40 mm Temperatura 50°C - 300°C	PZ	1	286,70

Polifusore con Bussole



CODICE	MISURA	UM	PZ	€
030 186 120	60/7 + Tornado 60 lt/min Press.7 bar	PZ	1	2.211,60

Sistema di Lavaggio Kit Tsunami





Pressatrice a Batteria
10,8 V / 1,5Ah
Mini 32

CODICE	MISURA	UM	PZ	€
030 186 125	2 batterie e 4 inserti	PZ	1	3.399,30



Pistola Silicone
Doppio Rinforzo

CODICE	MISURA	UM	PZ	€
030 186 130	D.225 mm	PZ	1	26,70



Seghetto professionale fisso

CODICE	MISURA	UM	PZ	€
030 186 133	Lunghezza lama di 30	PZ	1	20,50



Sbavatore Tubo

CODICE	MISURA	UM	PZ	€
030 186 135	Fino a 40 mm	PZ	1	22,60



Espansore e Sbavatore

CODICE	MISURA	UM	PZ	€
030 186 140	D. 10-12-14-16-18-22 mm	PZ	1	0



Termometro Digitale
Cavo e Sonda

CODICE	MISURA	UM	PZ	€
030 186 145	1 mt Sonda 10 cm 3,75mm	PZ	1	32,80



Cannello con Bruciatore

CODICE	MISURA	UM	PZ	€
030 186 150	Kit Cercoflam fiamma 1400°C 27 cm	PZ	1	82,00

